

Electric pump

EL604SHHA/B

PUMP SPECIFICATIONS	Mod. A	Mod. B
Capacity [m ³ /h]	100	200
Head [m]	49	35
Impeller diameter [mm]/type	435/3 blades closed	
Flanged bore size [DN.../PN...]	DN100/PN10	DN150/PN10
Cross section diameter [mm]	35	
Weight (without cable) [kg]	1100	1130

ELECTRIC MOTOR	
Power [kW-HP]	90-120
Voltage [V]/Current [A]	400/158
Phases/Poles/Frequency [Hz]	3/4/50
Speed [RPM]	1450
Insulation class	H
Power cable 20m (IEC 60245- 4)	H07RN-F 4G35

MATERIALS	
Casing	Spheroidal cast iron EN-GJS-500-7 (EN 1563)
Motor housing	Cast iron EN-GJL-250 (EN 1561)
Wear parts	High chrome EN-GJN-HV600 (XCr18) (EN 12513)
Main shaft	High tensile steel 39NiCrMo3 (AISI 9840)

SEALS / LUBRICANT	
Motor side seals	1 mechanical seal (silicon carbide in oil bath)
Impeller side seals	1 mechanical seal (silicon carbide in oil bath) + 1 lip seal (BUNA) + 1 V-RING (TPU)
Oil type	ISO 320

DIMENSIONS [mm]							
H	W	D	F	H1	A	B	C
1450	902	774	600	1000	374	418	363

PERFORMANCE CURVES

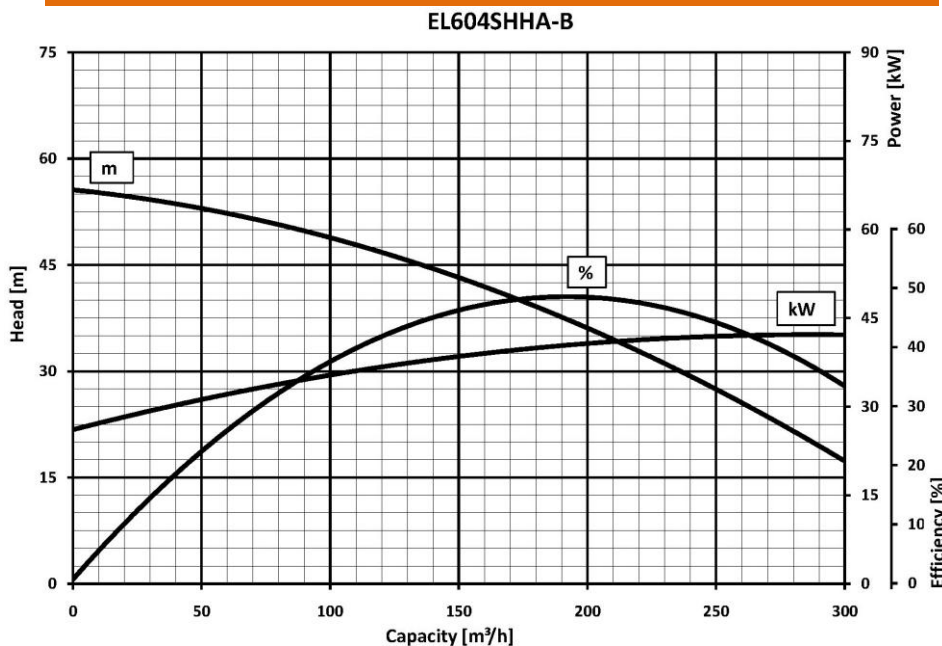

We reserve the right to make changes without notice

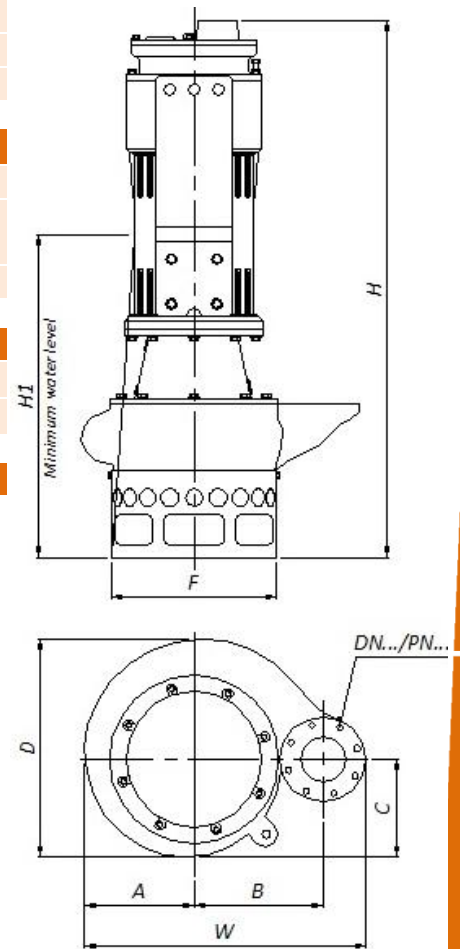

EL604SHHA-B

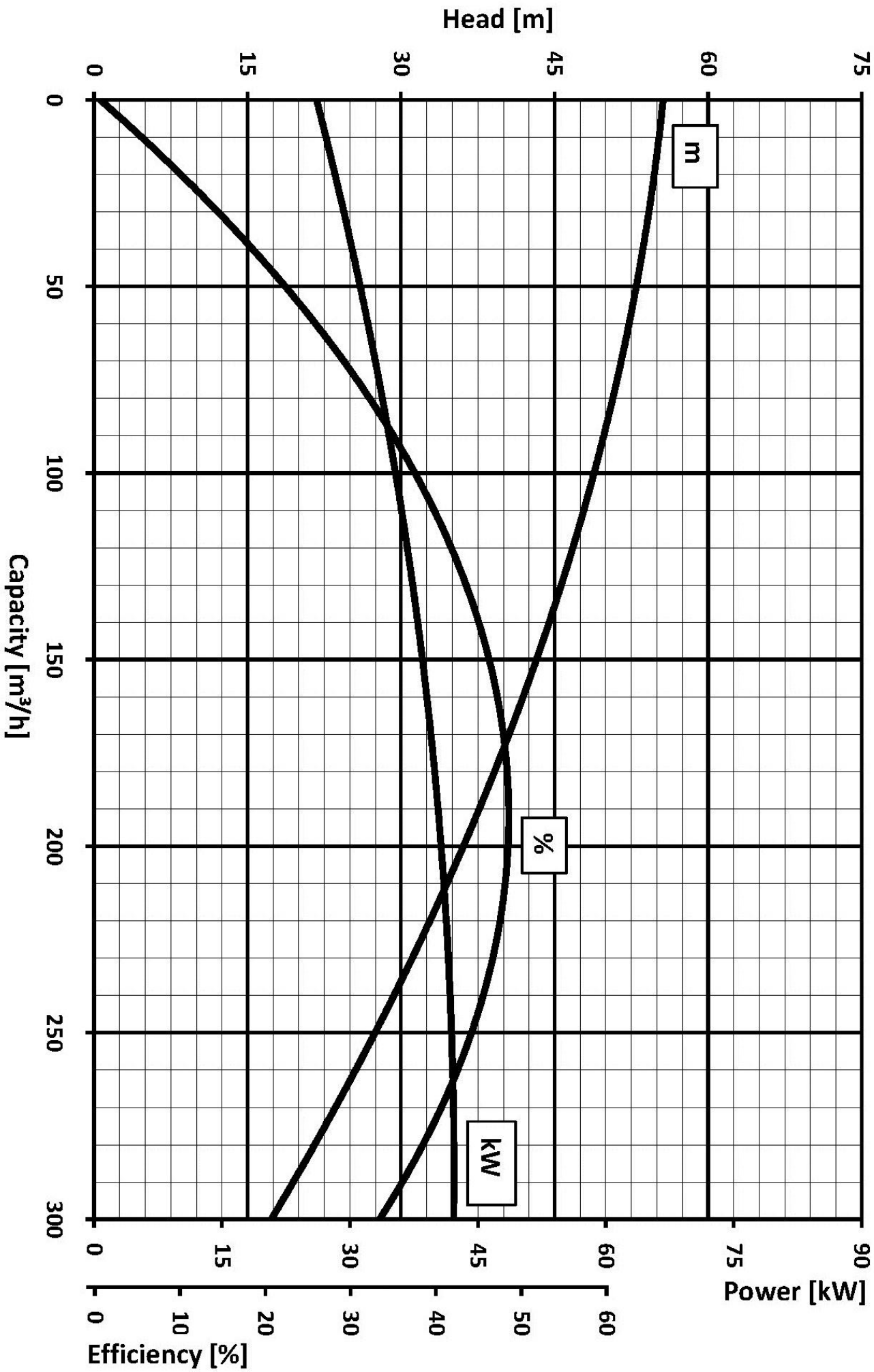

We reserve the right to make changes without notice