

DGX 50/2/G50V A0CM/50

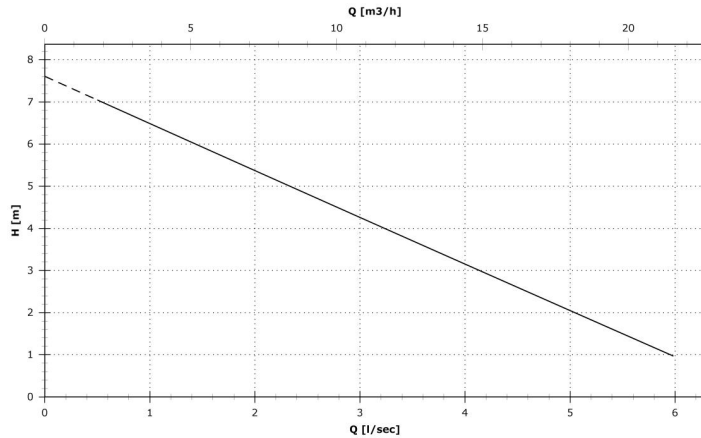

Special alloy pumps

Rated power output (P2) 0.37 kW

Free passage 38 mm

Technical data

Number of poles	2
Rated power output (P2)	0.37 kW
Input power (P1)	0.6 kW
Nominal absorbed current (In)	2.9 A
rated power factor (cos phi)	0.98
Nominal power frequency (f)	50 Hz
Rated nominal voltage(Vn)	230 V
N° phases	1
IPMotor	68
ATEX thermal class	not applicable
insulation class	F

Constructive characteristics

Outlet	G2"
Outlet orientation	V (vertical)
Type of starting	D
Weight	18 kg
Standard cable type	H07RN-F 4G1
EX cable type	N.A.
Standard paint type	Not applicable
Maximum acoustic pressure	70 dB
Set of standard mechanical seals	Two Silicon carbide mechanical seals (SiC)
Probe for water presence	

Use limits

Maximum operating temperature	40 °C
Maximum immersion depth	20 m
PH of treated fluid	5 to 10 pH
max starts per hour	20

Materials

Case	Cast Stainless Steel - CF-8M (12)
Shaft	Stainless Steel - AISI 316 (25)
Cooling jacket	Not applicable (00)
Standard gasket	Rubber - NBR (77)
EX gasket	Not applicable (00)
Nuts and bolts	Stainless Steel - Class A4-70 (43)
Hydraulic	Cast Stainless Steel - CF-8M (12)
Impeller	Stainless Steel - AISI 316 (25)
Cutting disk	Not applicable (00)
Cutter	Not applicable (00)
Grid	Not applicable (00)

Test limits

Density of treated fluid	1 Kg/dm ³
Viscosity of treated fluid	1 mm ² /s

Pump

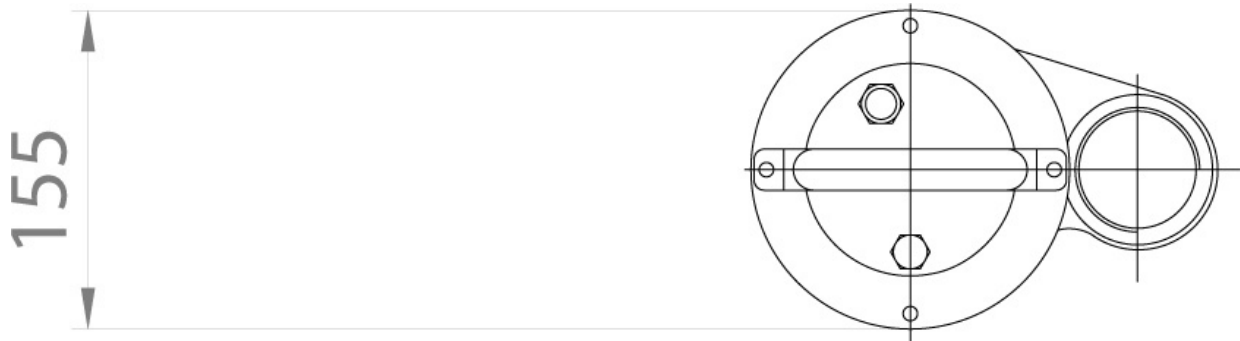
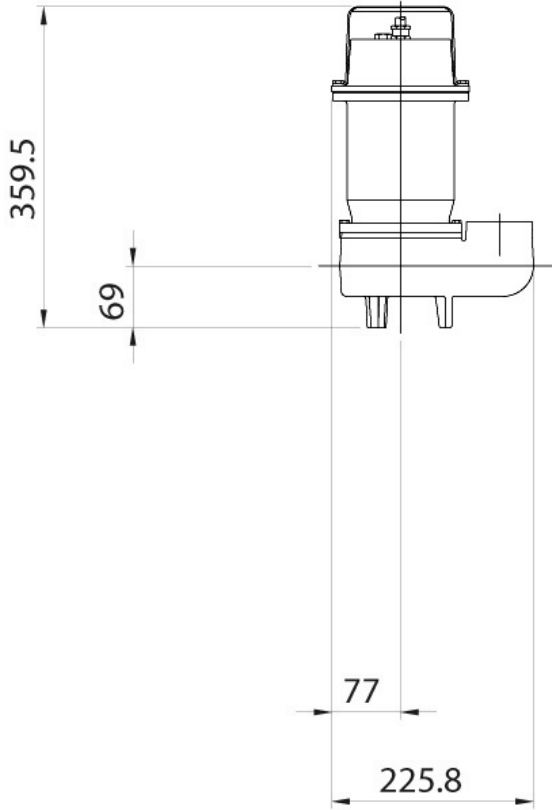

Bottom coupling devices with horizontal outlet

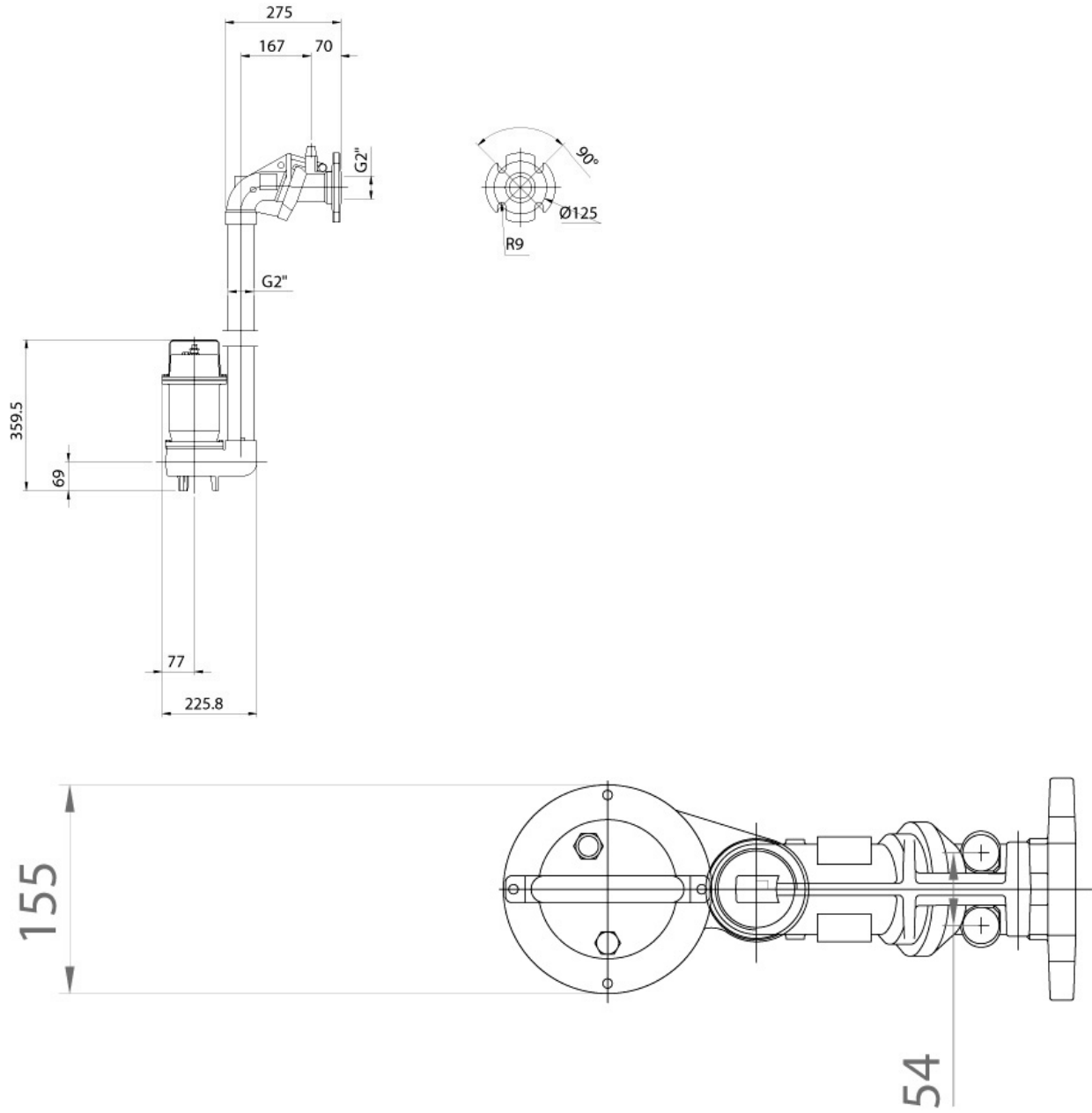

Bottom coupling devices with vertical outlet

