

Verderflex

Rollit 50



VERDERFLEX®

Description

The Verderflex Rollit 50 is the standard pressure version of the Rollit series of liquid-lubrication-free hose pumps, designed for applications in the chemical, food, pharma, environmental and many other industries.

Features and benefits

- Self priming and dry running capability
- Excellent solids handling i.e. ideal for abrasive media
- Gentle pumping of sensitive media
- No seal or valves
- Pumping of viscous and aggressive media
- FDA and ATEX approved

Technical data

Max. flow rate	12500 l/hr	Max. motor power	2.2 kW
Max. pump speed	165 RPM	Max. temperature of medium	80°C *
Max. discharge pressure	2 bar	Hose ID	50 mm
Max. suction lift	7 mWc	Weight (including motor)	108 kg

* 60°C continuous use, 80°C intermittent use

Materials

Description	Materials	Paint detail
Pump housing	Aluminium Alloy	RAL 6018 (green) / RAL 7021 (black grey)
Rotor	Aluminium Alloy	
Roller	3 rollers PTFE with 25% Carbon	
Base Plate	Carbon Steel	RAL 7021 (black grey)
Connector	Polypropylene hose tail Options: 316 Stainless Steel hose tail, 316 Stainless Steel BSP threaded, 316 Stainless Steel NPT threaded, 316 Stainless Steel BSPT BSP tapered thread, screw on 316 Stainless Steel ANSI 150lb flange, screw on DIN 316 Stainless Steel flange	
Hose options	Natural Rubber (NR), Neoprene (CR) and Natural rubber food (FN) according to FDA CFR21	

Options and accessories

- Special drive design depending on customers demands
- Mechanical or electronic adjustment of speed and flow
- Quick-coupling systems, flanges, hygienic fittings
- Pulsation dampers
- Hose monitor
- Mobile mounting available
- Special paint finishes
- Pump control systems
- Dosing systems



Verderflex

Rollit 50



0 Bar 1.250 l/rev
2 Bar 1.042 l/rev

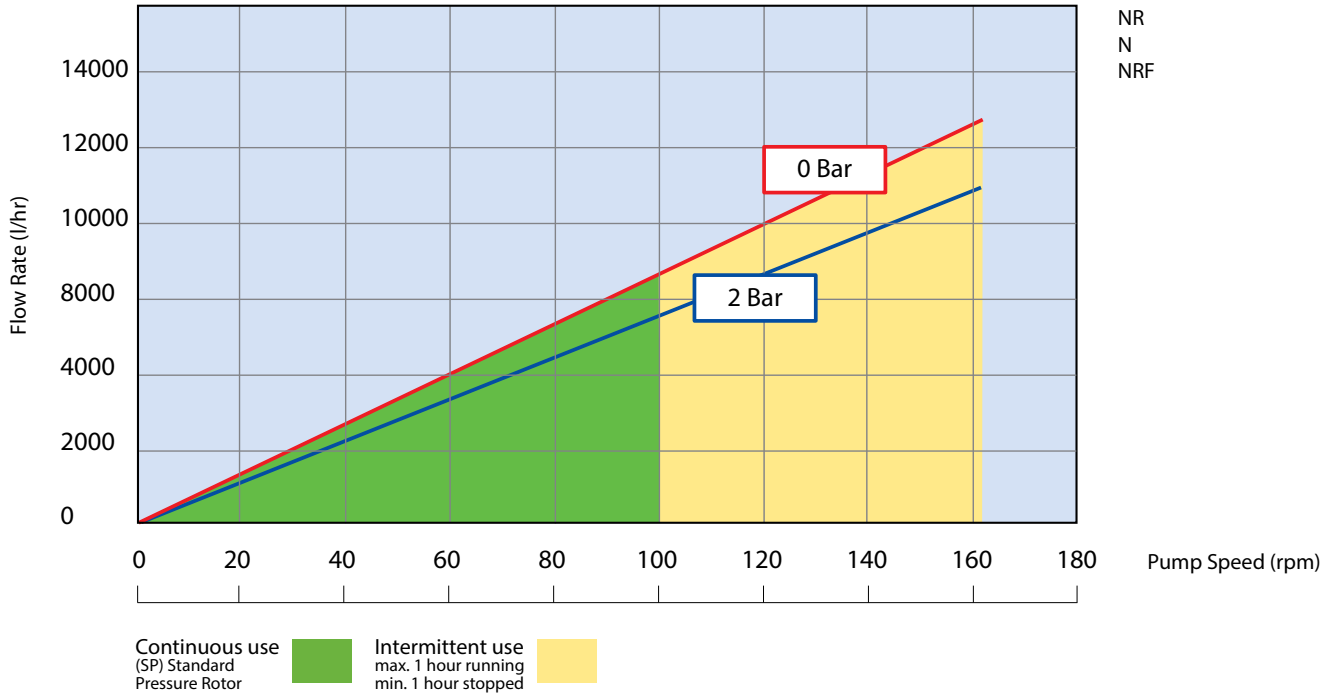

Flows are typical and were measured with water at 20°C with no suction lift or discharge pressure. Actual flows will vary according to suction conditions, discharge pressure and normal component production tolerances.

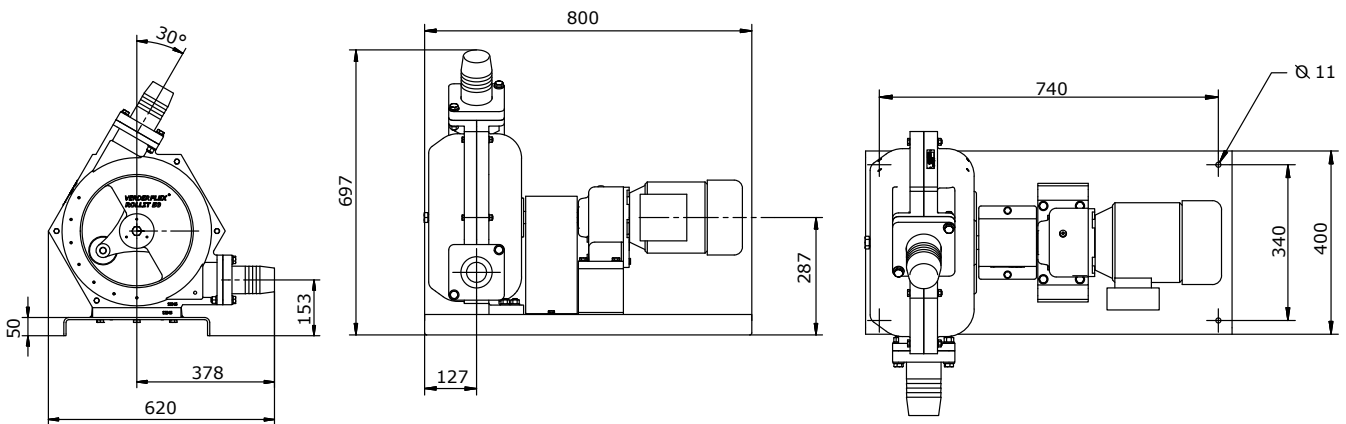

All dimensions are in mm.
All dimensions and weights are for guidance only.

Find your local supplier
at www.verderflex.com

For construction installation and floor mounting drawings
please contact your local authorised Verderflex® distributor.

VERDER
passion for pumps

VERDERFLEX®