

# Verderflex VF80

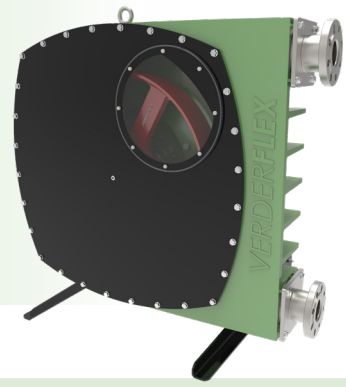

**VERDERFLEX®**

Description	Material	Paint Detail
Pump Housing	Cast Iron (GG25)	Green Powder Coated
Front Cover	Carbon Steel with Perspex Inspection Window	Powder Coated
Rotor	Cast Iron (GG25)	
Rotor Shoes	Aluminium (6082T6)	
Port Flange	304 Stainless Steel Universal slotted design fits with 80 mm 3" DIN PN16, ANSI 150# & JIS10K Tri-Clamp Port Flange Assembly DIN 32676 available on request	
Inserts	Stainless Steel (316L) Options: Polypropylene, P.V.D.F. Inserts*	
Mounting Frame	Carbon Steel	Powder Coated
Lubricant	Verderlube - Glycerine based compound** Verdersil - Silicone oil***	
Hose	Natural Rubber (NR) Options: Nitrile Buna Rubber (NBR) Ethylene Propylene Diene Mono-mer (EPDM), Food Grade Nitrile Buna (NBRF) and Hypalon® (CSM)	

Typical Pump Unit Weight 1057 - 1074 kg

\* Temperature Limit for PP insert is 35°C and for PVDF insert is 80°C.

\*\* Temperature Limit for Verderlube is 50°C.

\*\*\* Suitable for application above 50°C, but subject to maximum temperature limit of the hose and applications involving strong oxidising agents and nitrogenous compounds.

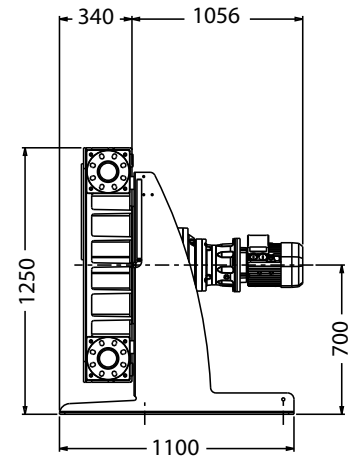
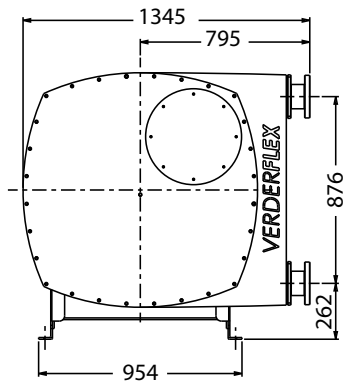
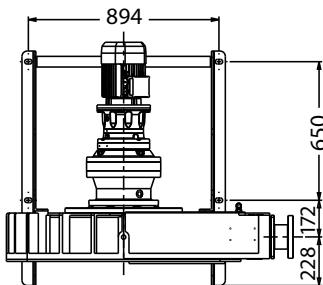

All dimensions are in mm.  
All dimensions and weights are for guidance only.



# Verderflex VF80

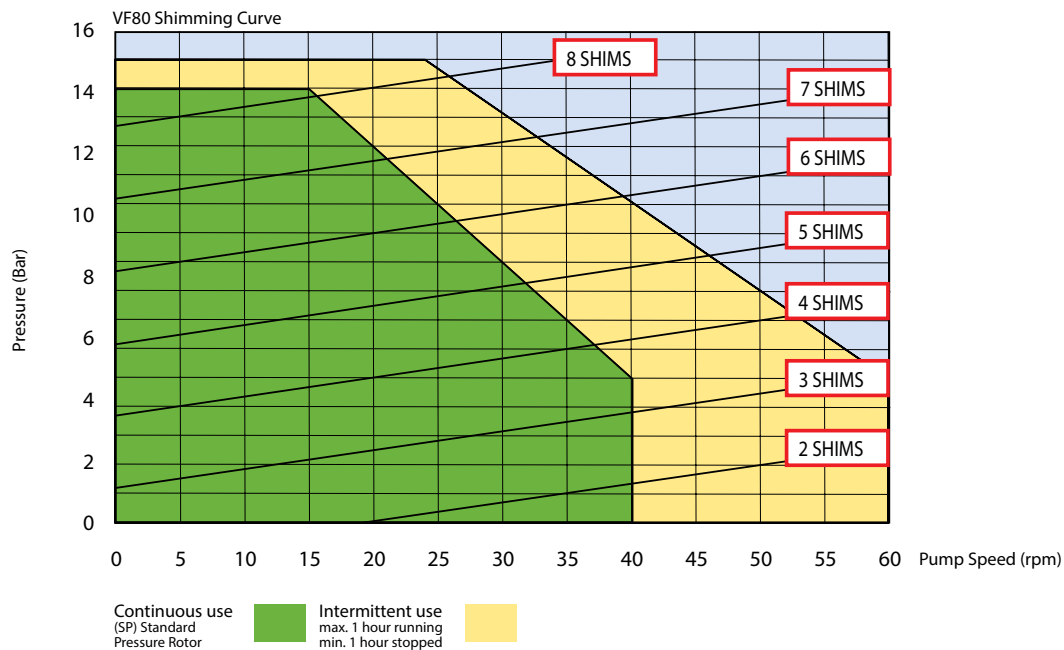
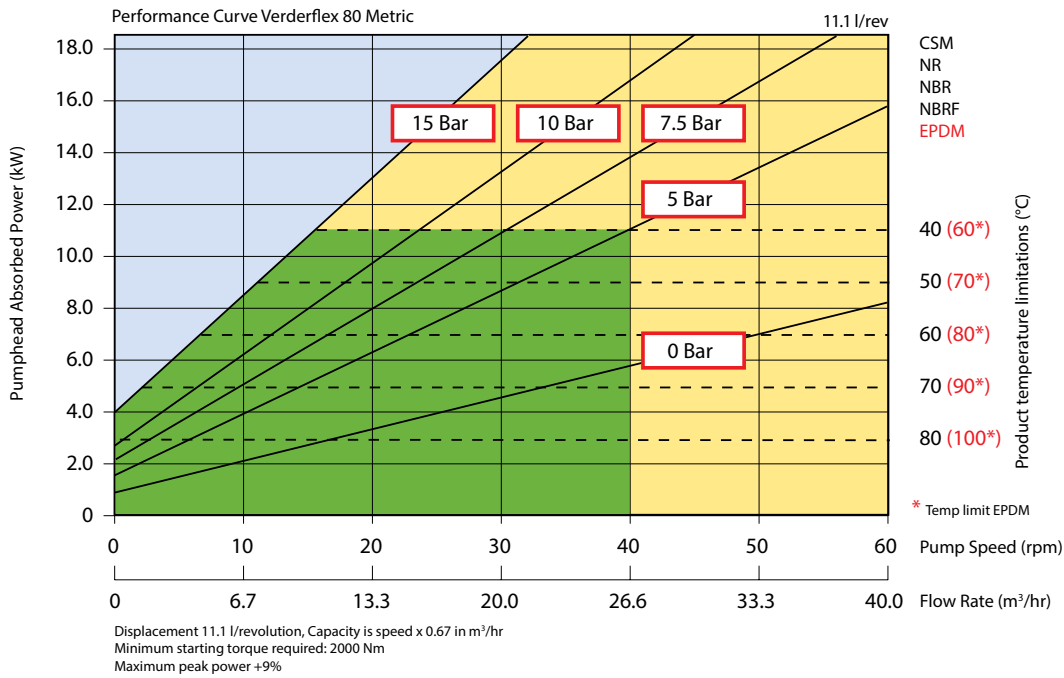
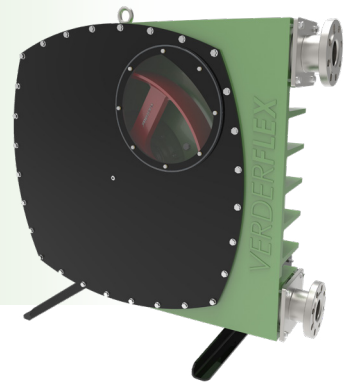

For product temperatures above 65°C and/or viscosity above 2000 mPas use one shim less than shown

Flows are typical and were measured with water at 20°C with no suction lift or discharge pressure. Actual flows will vary according to suction conditions, discharge pressure and normal component production tolerances.

Find your local supplier  
at [www.verderflex.com](http://www.verderflex.com)

For construction installation and floor mounting drawings  
please contact your local authorised Verderflex® distributor.

**VERDER**  
passion for pumps