

HYDROPOMPE	SINGLE CHANNEL IMPELLER	DN 65
F SERIES		50 Hz
N302T/16 - N302T		2 POLE

USE

Submersible electric pumps particularly suitable for pumping industrial sewage, screened waste water and mud in the pumping stations. They can be used also to lift clear and dirty water and rain water.

MATERIALS

Cover

Cast iron EN GJL 200 (UNI EN 1561)

Motor housing

Cast iron EN GJL 200 (UNI EN 1561)

Pump housing

Cast iron EN GJL 200 (UNI EN 1561)

Bearing housing

Cast iron EN GJL 200 (UNI EN 1561)

Impeller

Cast iron EN GJL 200 (UNI EN 1561)

Seal motor side

Seal ring

Mechanical seal impeller side

Silicon Carbide/Silicon Carbide (SiC/SiC)

Motor shaft

Stainless steel AISI 420

Bolts and nuts

Stainless steel Classe A2

Cable

10 meters type H07RN-F 4G1,5mm²

LIMITS TO USE

Max temperature of the liquid pumped

+40°C

pH of the liquid pumped

6÷10

Max immersion depth

20 m

Liquid density

1,0 kg/dm³

Min immersion depth for continuous service

445 mm

Free passage

50 mm

Max number starts/hour

20

Acoustic pressure level issued

<70dB(A)

MOTOR

The electric motor is asynchronous with squirrel cage rotor in oil bath

Class of insulation F

Protection degree IP68

2pole; 50Hz

Main voltage values and relative tolerance in relation to the rated voltage value:

THREE-PHASE

230V ±10%

400V ±10%

Other voltages on request.

OTHER FEATURES ON REQUEST

With industrial plug (IEC 60309-2) in accordance with EN 60335-2-41

Frequency 60 Hz (*see specific catalogue*)

Other voltages

With food grade white oil

TECHNICAL DATA

MODEL	P1 kW	P2		VOLTAGE V	CURRENT A	CABLE m	WEIGHT kg
		kW	CV				
N302T/16	2,5	1,6	2	230/400 (3~)	7,6/4,4	10	50
N302T	3,2	2,2	3	230/400 (3~)	9,0/5,2	10	50

F SERIES	N302T/16 - N302T		DN 65
			50 Hz
			2 POLE

PERFORMANCE RANGE

CAPACITY													
<i>l/s</i>	0	4	6	8	9	10	11	12	13	14	15	16	18
<i>m³/h</i>	0	14,4	21,6	28,8	32,4	36,0	39,6	43,2	46,8	50,4	54,0	57,6	64,8
<i>l/min</i>	0	240	360	480	540	600	660	720	780	840	900	960	1080

MODEL	CURVE <i>N°</i>	HEAD <i>m</i>												
		N302T/16	1	18,5	12,5	10,4	8,5	7,7	6,8	5,7	4,9	3,6	2,3	1,0
N302T	2	24,0	17,8	15,3	13,2	12,0	11,3	10,2	9,1	7,9	6,6	5,1	3,6	1,0

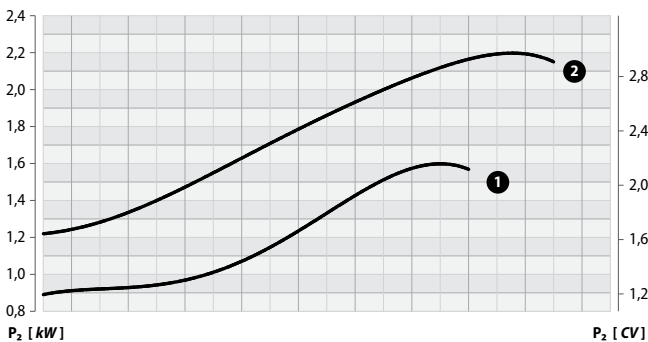
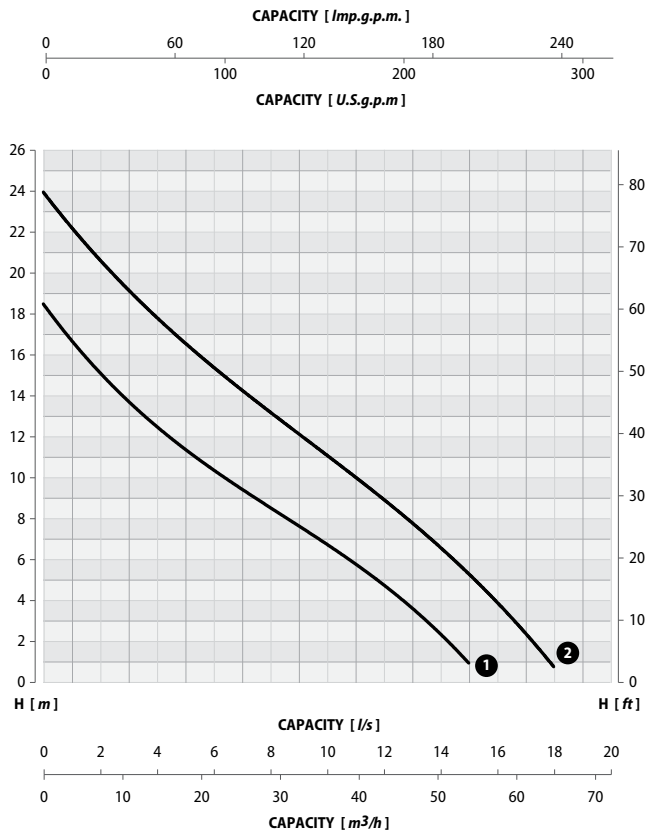

Performance tolerance in according to UNI/ISO 9906 Grade 2

F SERIES

N302T/16 - N302T



SINGLE CHANNEL IMPELLER

DN 65

50 Hz

2 POLE

INSTALLATION DIMENSIONS

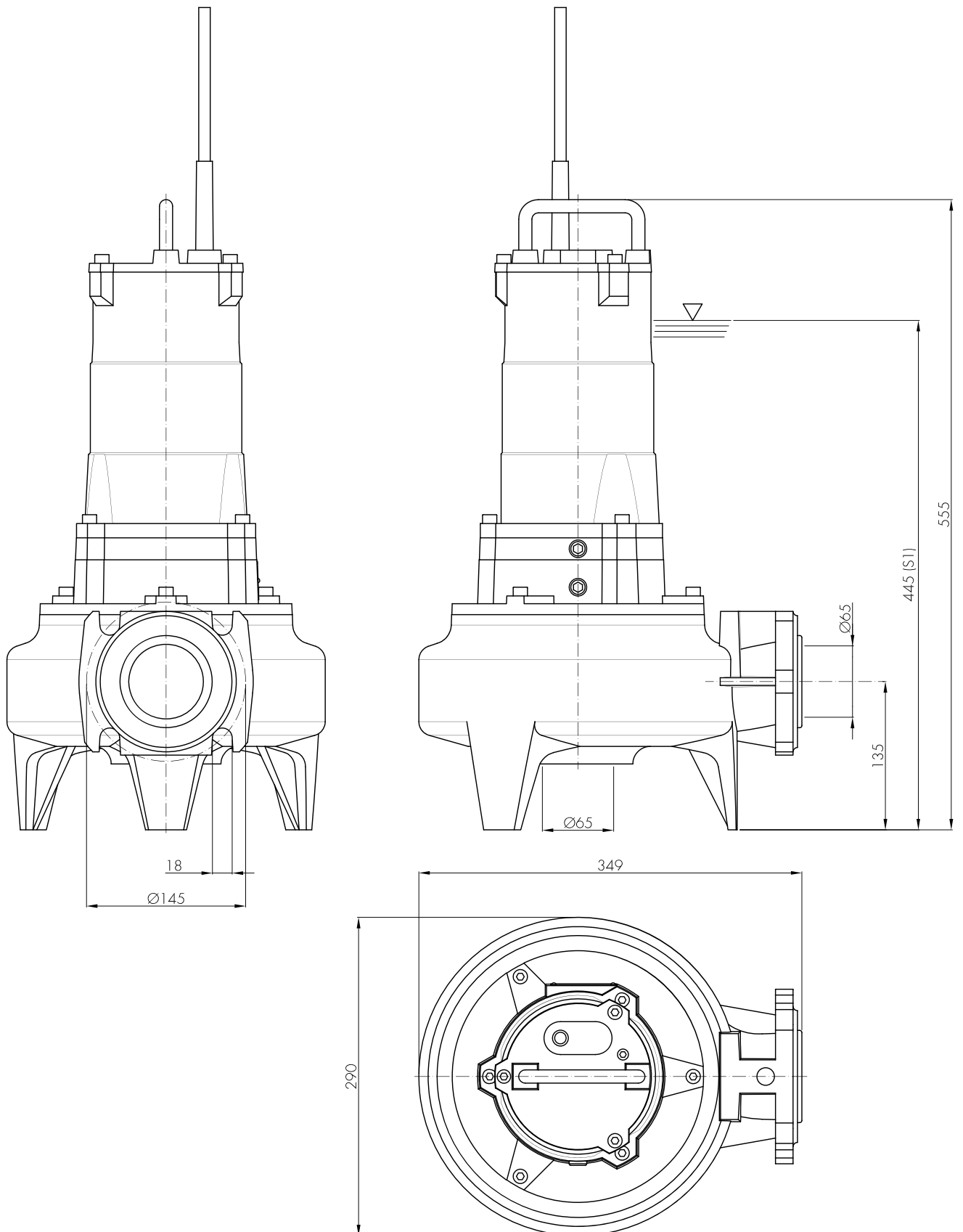

F SERIES	N302T/16 - N302T	 SINGLE CHANNEL IMPELLER	DN 65
			50 Hz
			2 POLE

PERMANENT INSTALLATION WITH COUPLING SYSTEM

It is the recommended installation for the permanent pumping station. The electric pump is guided by two pipes and it is connected automatically to the coupling system. The quick connection ensures that the pump can be easily removed and re-installed.

PORTABLE INSTALLATION

Transportable as emergency pump with connection to the hose and for free installation in the well.

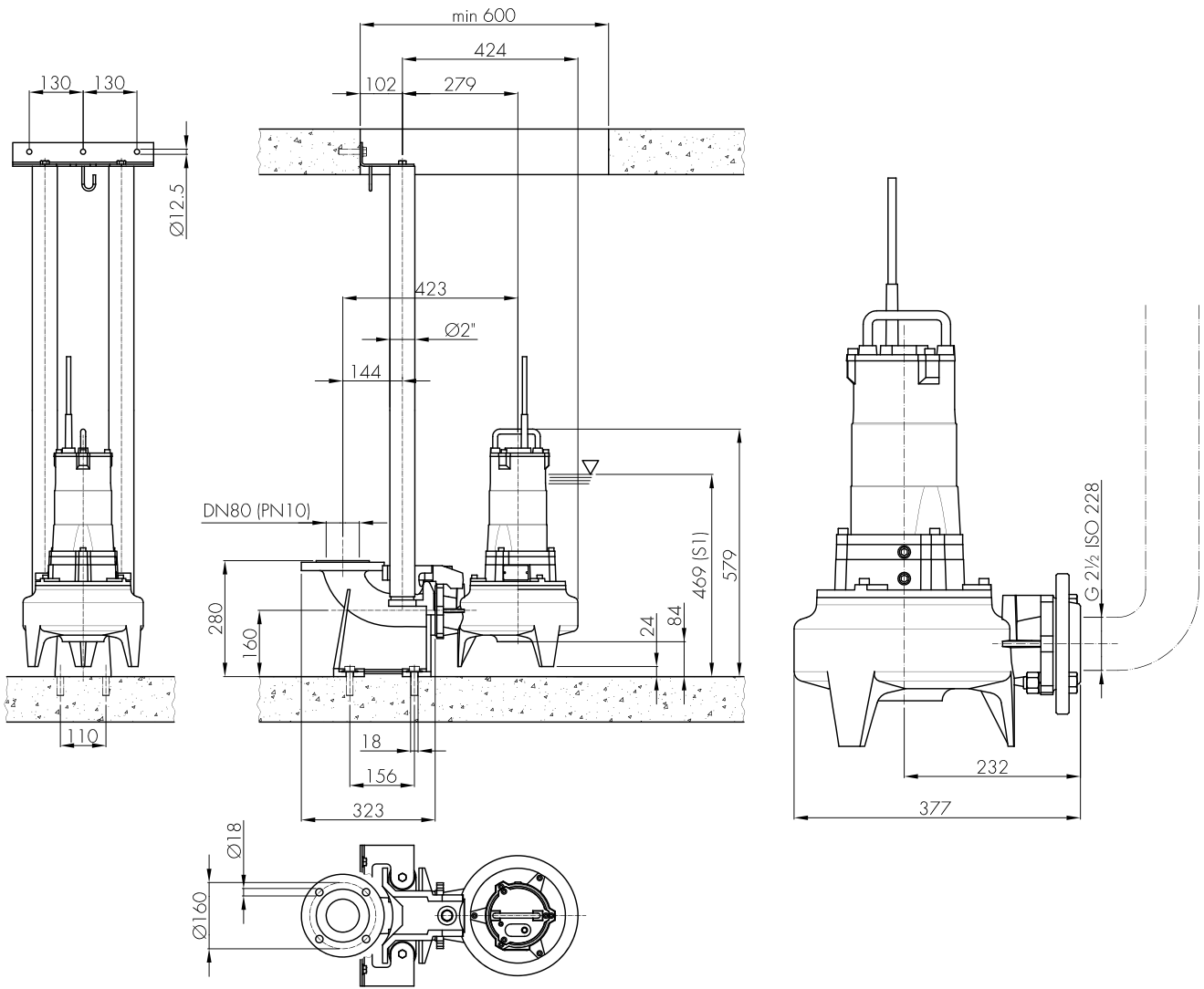

NOTES



.....

.....

.....

.....

.....