

VERDERMAG[®]



Centrifugal Magdrive Pump

Original Operating Manual

Style 1, MKII, High System Pressure Pumps

Version 1.0v-06/2020

Print-No. 01

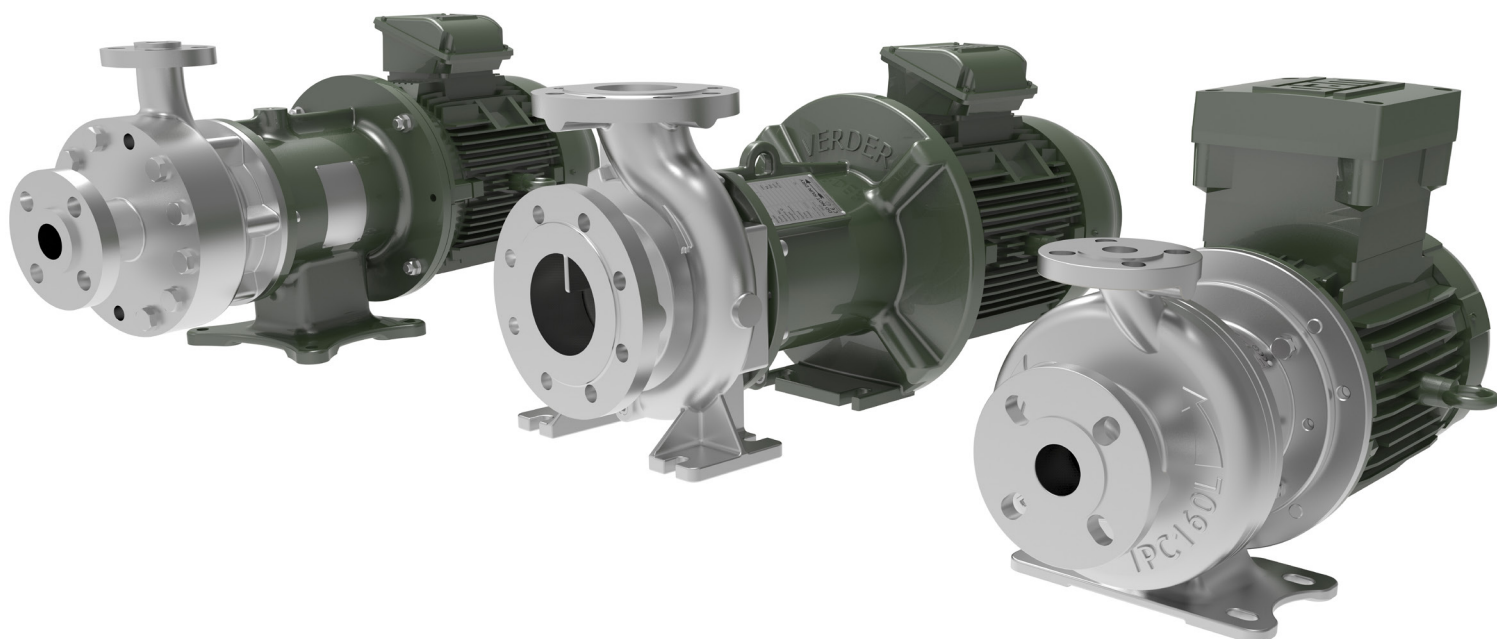

VERDER
passion for pumps



Version 1.0v -06/2020
Print-N o. 01

Original Operating Manual Style 1, MKII, High System Pressure Pumps



The information in this document is essential for the safe operation and servicing of VerderMag® Global centrifugal pumps in ATEX environment. This document must be read and understood thoroughly prior to installation of pump, electrical connection and commissioning.

Table of Contents

1	About this Document		
1.1	Target Groups		
1.2	Warnings and Symbols Used in the Manual		
2	Safety		
2.1	Intended Use		
2.2	General Safety Instructions		
2.2.1	Product Safety		
2.2.2	Obligation of the Operating Company		
2.2.3	Obligation of Personnel		
2.3	Specific Hazards		
2.3.1	Hazardous Pumped Liquids		
2.3.2	Sharp Edges		
2.3.3	ATEX Environment		
3	Transport, Storage and Disposal		
3.1	Transport		
3.1.1	Unpacking and Inspection on Delivery		
3.1.2	Lifting		
3.2	Treatment for Storage		
3.3	Disposal		
4	Layout and Function		
4.1	Design Details		
4.2	ATEX Introduction		
4.3	Labelling		
4.3.1	Name Plate		
4.3.2	ATEX Name Plate		
4.4	Layout		
4.4.1	Verdermag® Global Centrifugal Pumps		
5	ATEX Specification		
5.1	Gas/Dust Group		
5.2	ATEX Category		
5.3	Temperature Class		
5.3.1	'T-max' Limited by Material Selection		
5.3.2	Dust (D) Protection: Maximum Allowable Temperature		
5.4	Non-electrical Protection Concept (h)		
6	Installation and connection		
6.1	Preparing for Installation		
6.1.1	Checking the Ambient Conditions		
6.1.2	Preparing the Installation Site		
6.1.3	Preparing the Foundation and Surface		
6.2	Planning the Pipes		
6.3	Electrical Connection		
6.3.1	Connecting to a Power Supply		
7	Commissioning and Operation		
7.1	Pre-commissioning the Pump		
7.1.1	Checking the Direction of Rotation		
7.1.2	Checks for ATEX Explosion Hazard Zone		
7.2	Commissioning the Pump		
7.2.1	Notes for Commissioning the Pump in ATEX Explosion Hazard Zone		
7.3	Notes for Operation		
7.3.1	Switching ON the Pump		
7.3.2	Switching OFF the Pump		
7.4	Shutdown and Removal / Storing the Pump over Longer Periods		
7.5	Shutdown Without Removal Over Longer Periods (On-Site Preservation)		
8	Inspection, Maintenance and Repairs		
8.1	Inspections		
8.2	Maintenance		
8.2.1	Cleaning the Pump		
8.2.1	Bearing Wear Chart		
8.3	Repair		
8.3.1	General Disassembly/Assembly		
8.3.2	Returning the Pump to the Manufacturer		
8.4	Ordering Spare Parts		
9	Troubleshooting		
9.1	Pump Malfunctions		
10	List of Figures and Tables		
10.1	List of Figures		
10.2	List of Tables		
11	 II 2GD EU Declaration of Conformity		
Appendix A - Style 1, MKII, High System Pressure Pumps			
12	Technical Specifications		
12.1	Pump Range Specifications		
12.2	Ambient Conditions		
12.3	Preservatives		
12.4	Pumped Media Limitations		
13	Limitations for use in ATEX Environment		
13.1	Speed Limitations		
13.2	Maximum Pressure		
13.3	Maximum Temperature		
13.4	Lightning Strike		
13.5	Ionising Radiation		
13.6	Motor Protection		
13.7	Pumped Media		

1. About this Document

Verdermag® Global Centrifugal Pumps have been developed according to the latest technology and subject to continuous quality control. These operating instructions are intended to facilitate familiarization with the pump and its designated use. This manual will act as a guide for operating the pump in NON-ATEX and ATEX environment. You are advised to follow these guidelines to operate the pump correctly. These operating instructions do not take local regulations into account; the operator must ensure that such regulations are strictly observed by all, including the personnel responsible for installation.

1.1 Target Groups

Target Groups	Duty
Operating Company	<ul style="list-style-type: none"> ▶ Keep this manual available at the operating site of the pump. ▶ Ensure that personnel read and follow the instructions in this manual and any other applicable documents, especially all safety instructions and warnings. ▶ Observe any additional rules and regulations referring to the system.
Qualified personnel, fitter	<ul style="list-style-type: none"> ▶ Read, observe and follow this manual and the other applicable documents, especially all safety instructions and warnings.

Table 1 Target Groups

1.2 Warnings and Symbols Used in the Manual



Warning	Risk Level	Consequences of disregard
 DANGER	Immediate risk	Death, serious bodily harm
 WARNING	Potential acute risk	Death, serious bodily harm
 CAUTION	Potential hazardous situation	Potential damage to the pump
Note	For information	Possible incorrect use / maintenance of pump

Table 2 Warnings Used in the Manual





Symbol	Meaning
	Safety warning sign in accordance with DIN 4844 - W9 <ul style="list-style-type: none"> ▶ Take note of all information highlighted by the safety warning sign and follow the instructions to avoid injury or death.
▶	Instruction
1., 2.,	Multiple-step instructions
✓	Precondition
→	Cross-reference
	Information
	ATEX related instructions

Table 3 Symbols Used in the Manual

2 Safety

 The manufacturer does not accept any liability for damage resulting from disregard of this documentation.

2.1 Intended Use

- ▶ Only use the pump to handle compatible fluids as recommended by the manufacturer (→ Appendix A)
- ▶ Adhere to the operating limits.
- ▶ Consult the manufacturer regarding any other use of the pump.
- ▶ Pumps delivered without a motor must be fitted with a motor in accordance with the provisions of EC Machinery Directive 2006/42/EC.

Prevention of obvious misuse (examples)

- ▶ Note the operating limits of the pump with regard to temperature, pressure, flow rate and motor speed (→ Appendix A)
- ▶ Do not operate the pump with any inlet/outlet valves closed
- ▶ Only install the pump as recommended in this manual. For example, the following are not allowed:
 - Installing the pump without proper support.
 - Installation in the immediate vicinity of extreme hot or cold sources.

2.2 General Safety Instructions

 Observe the following regulations before carrying out any work.

2.2.1 Product Safety

- These operating instructions contain fundamental information which must be complied with during installation, operation and maintenance. Therefore, this operating manual must be read and understood both by the installing personnel and the responsible trained personnel / operators prior to installation and commissioning, and it must always be kept easily accessible within the operating premises of the machine.
Not only must the general safety instructions laid down in this chapter on “Safety” be complied with, but also the safety instructions outlined under specific headings.
- Operate the pump only if it and all associated systems are in good functional condition.
- Only use the pump as intended, fully aware of safety and risk factors involved and the instructions in this manual.
- Keep this manual and all other applicable documents complete, legible and accessible to personnel at all times.
- Refrain from any procedure or action that would pose a risk to personnel or third parties.
- In the event of any safety-relevant faults, shut down the pump immediately and have the malfunction corrected by qualified personnel.
- The installation of the pump must comply with the requirements of installation given in this manual and any local, national or regional health and safety regulations.

2.2.2 Obligation of the Operating Company

Safety-conscious operation

- Ensure that the following safety aspects are observed and monitored:
 - Adherence to intended use
 - Statutory or other safety and accident-prevention regulations
 - Safety regulations governing the handling of hazardous substances if applicable
 - Applicable standards and guidelines in the country where the pump is operated
- Make personal protective equipment available pertinent to operation of the pump.

Qualified personnel

- Ensure that all personnel tasked with work on the pump have read and understood this manual and all other applicable documents, including the safety, maintenance and repair information, prior to use or installation of the pump.
- Organize responsibilities, areas of competence and the supervision of personnel.
- Have all work carried out by specialist technicians only.
- Ensure that trainee personnel are under the supervision of specialist technicians at all times when working with the pump.

Safety equipment

Provide the following safety equipment and verify its functionality:

- For hot, cold and moving parts: safety guarding should be provided by the operating company.
- For potential build up of electrostatic charge: ensure appropriate grounding if and when required.

Warranty

The warranty is void if the customer fails to follow any Instruction, Warning or Caution in this document. Verder has made every effort to illustrate and describe the product in this document. Such illustrations and descriptions are however, for the sole purpose of identification and do not express or imply a warranty that the products are merchantable or fit for a particular purpose, or that the products will necessarily conform to the illustration or descriptions.

Obtain the manufacturer's approval prior to carrying out any modifications, repairs or alterations during the warranty period. Only use genuine parts or parts that have been approved by the manufacturer.

For further details regarding warranty, refer to terms and conditions.

2.2.3 Obligation of Personnel



It is imperative that the instructions contained in this manual are complied with by the operating personnel at all times.

- ▶ Pump and associated components:
 - Do not lean or step on them or use as climbing aid
 - Do not use them to support boards, ramps or beams
 - Do not use them as a fixing point for winches or supports
 - Do not de-ice using gas burners or similar tools
 - Do not put magnetic field sensitive items such as credit cards, floppy disks or magnetic tapes near magnets
 - Do not place hands or fingers between the magnets
 - Do not put steel or iron tools near the magnets. Steel tools such as wrenches and screwdrivers are easily attracted by the magnets and can break them on contact.
 - People who are assisted by electronic devices that may or may not contain reed switches should not handle magnetic pumps or their parts. Pacemaker and implantable defibrillators are examples of these devices. The magnets used in this pump are some of the strongest available in the world.
- ▶ Do not remove the safety guarding for hot, cold or moving parts during operation.
- ▶ Reinstall the safety equipment on the pump as required by regulations after any repair / maintenance work on the pump.
- ▶ Liquid poured into the casing for initial priming must be compatible to incoming liquid.

2.3 Specific Hazards

2.3.1 Hazardous Pumped Liquids



Follow the statutory safety regulations when handling hazardous pumped liquids (e.g. hot, flammable, poisonous or potentially harmful).

In an ATEX explosion hazard zone, when the pump is operated as intended (within its working specifications), the pumps maximum surface temperature must not exceed the temperature category of the explosion protection zone for which it is intended.

The temperature class rating (→ 5.3 Temperature Class) of the pump is determined by the temperature of the process fluid being pumped.

End user to put in place appropriate safety measures i.e process flow, power and temperature monitors.

The end user must ensure that the maximum allowable hazardous area temperature is not exceeded while pumping 'hot' liquid, refer to (→ 5.3 Temperature Class)

Use appropriate Personal Protective Equipment when carrying out any work on the pump.

2.3.2 Sharp Edges

Pump parts, such as the shims and impellers, can be sharp

- Use protective gloves when carrying out any work on the pump

2.3.3 ATEX Environment



Failure to implement the necessary safety procedures and failure to disclose the intended use of a pump within an explosive atmosphere as laid down in latest EU Atex Directive 2014/34/EU will void all warranty for the product. (Refer warranty terms and conditions for more details).

Verder shall not be liable for any injuries, losses or damages including, but not limited to any personal injuries, anticipated or lost profits, incidental damages, consequential damages, costs, time charges, or other damages or losses, in connection with the instrument, its use or any replacement parts if the customer fails to follow any Instruction, Warning or Caution in this document.

3 Transport, Storage and Disposal

3.1 Transport

 Always transport the pump in a stable position and ensure that the pump is securely attached to the pallet.

3.1.1 Unpacking and Inspection on Delivery

1. Report any transport damage to the manufacturer/distributor immediately.
2. Retain the pallet if any further transport is required.

3.1.2 Lifting



DANGER

Death or crushing of limbs can be caused by falling loads!

1. Use lifting gear appropriate for the total weight to be transported.
2. Make sure the pump and accessories are lifted and moved by qualified lifting personnel equipped with suitable lifting gear.
3. Do not stand under suspended loads.
4. Use a suitable lifting device to lift the pump and secure the pump as outlined in the following sketch. Take note of the centre of gravity.
5. Never use the electrical cable to lift the pump.
6. Before you lift the pump, ensure that neither the pump, the motor, nor the coupling guard can be moved on the base plate.

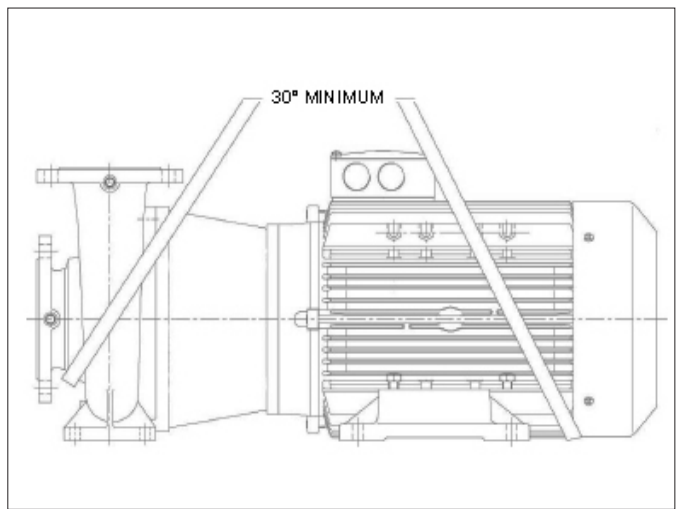

Figure 1 Lifting the Verdermag® Global Centrifugal Pumps

3.2 Treatment for Storage

1. If the pump unit is not to be used immediately, it should be stored carefully in a horizontal position, in a sheltered, dry location.
2. Unpainted carbon steel or cast iron parts should be coated with rust inhibitor and the pump should be stored in a dry, dust free environment not exceeding +10 to 50°C (+50 to 122°F). (→ Appendix A)
3. Close all openings with blanks, plugs or plastic covers.
4. Closure's fitted over suction and discharge openings must remain in position. Bearings and coupling if fitted must be carefully protected against dust, grit and other foreign matter.
5. Make sure the storage room meets the following conditions:
 - Dry, humidity not to exceed 85%, non-condensing
 - Out of direct sunlight
 - Vibration-free; minimize
 - Dust-free; minimize
6. Turn the shaft of the impeller every month to prevent oxidation and rust by rotating the impeller.
7. Ensure the rust inhibitor is fully removed from the pump before putting it back into use.

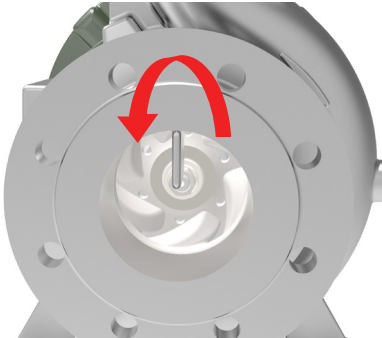



Figure 2 Turn the Shaft of the Impeller

3.3 Disposal

 With prolonged use, pump parts can get contaminated by hazardous pumped liquids to such an extent that cleaning may be insufficient.



Risk of poisoning and environmental damage by the pumped liquid or oil!

- ▶ Use suitable personal protective equipment when carrying out any work on the pump.
 - ▶ Prior to disposal of the pump:
 - Collect and dispose the lubricant in accordance with local regulations.
 - Collect and dispose of any leaking pumped liquid or oil in accordance with local regulations.
 - Neutralize residues of pumped liquid in the pump.
-
- ▶ Dispose of the pump and associated parts in accordance with local regulations.

4 Layout and Function

 Verdermag® Global Centrifugal Pumps operate using a mag drive principle, using a two magnet assembly to create flow by transferring torque from the pump shaft to the impeller. The motor drives the pump shaft, which rotates the outer magnet. The outer magnet pulls an inner magnet, exploiting the polarities in each of the magnets. The inner magnet then rotates the impeller, creating a centrifugal force moving the fluid into the process line.

4.1 Design Details

 Verdermag® Global Centrifugal Pumps are hermetically sealed and therefore 100% leak-free. There are no mechanical seals inside the pump. The fluid and inner workings are completely contained from the environment with no risk of leaking.

4.2 ATEX Introduction

 ATEX assessment for the Verdermag® Global Centrifugal pumps are based on Equipment group II category 2, Ref BS EN 60079-36:2016 and in compliance with latest ATEX product Directive 2014/34/EU, dated 26 February 2014 (which replaces the previous Directive 94/9/EC).

Verder strongly recommends the user to ensure the ATEX rated equipment is installed and operated in accordance with ATEX “workplace” Directive 1999/92/EC. Any associated equipment installed or used within an Explosive environment should be rated to appropriate ATEX standard.

4.3 Labelling

4.3.1 Name Plate

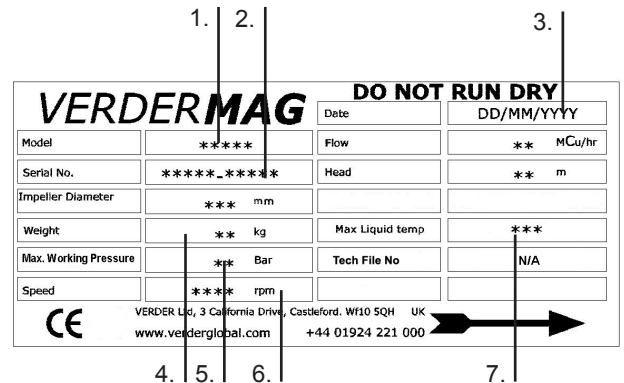



Figure 3 Name Plate

- | | |
|---|----------------------------|
| 1. Pump Type | 5. Max. Working Pressure |
| 2. Serial Number | 6. Duty Speed |
| 3. Date of Manufacture | 7. Max. Liquid Temperature |
| 4. Weight of Pump Only (Motor not included) | |

 When requesting spares, the model and serial number should always be quoted.

4.3.2 ATEX Name Plate

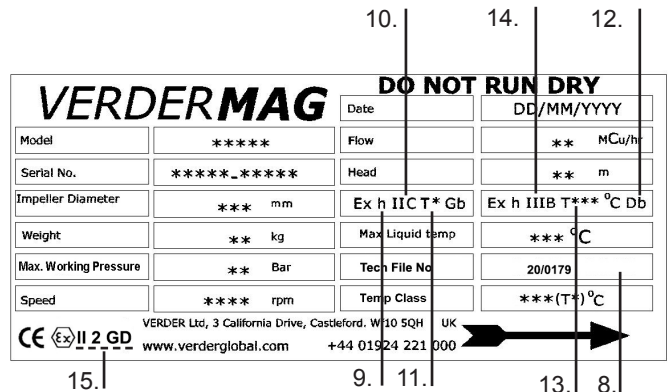

Figure 4 ATEX Name Plate

- | | |
|--|---|
| 8. Tech File Number | 13. Max. Surface Temp. Dust Environment |
| 9. Protection Concept | 14. Dust Group |
| 10. Gas Group | 15. Equipment Group II |
| 11. Temp. Class Gas Group | Equipment Category 2GD |
| 12. Equipment Protection Level: 'Gb' for Gas 'Db' for Dust | |

NOTE

Dust Environment references on the pump label may be omitted if not applicable.

4.4 Layout

4.4.1 Verdermag® Global Centrifugal Pumps

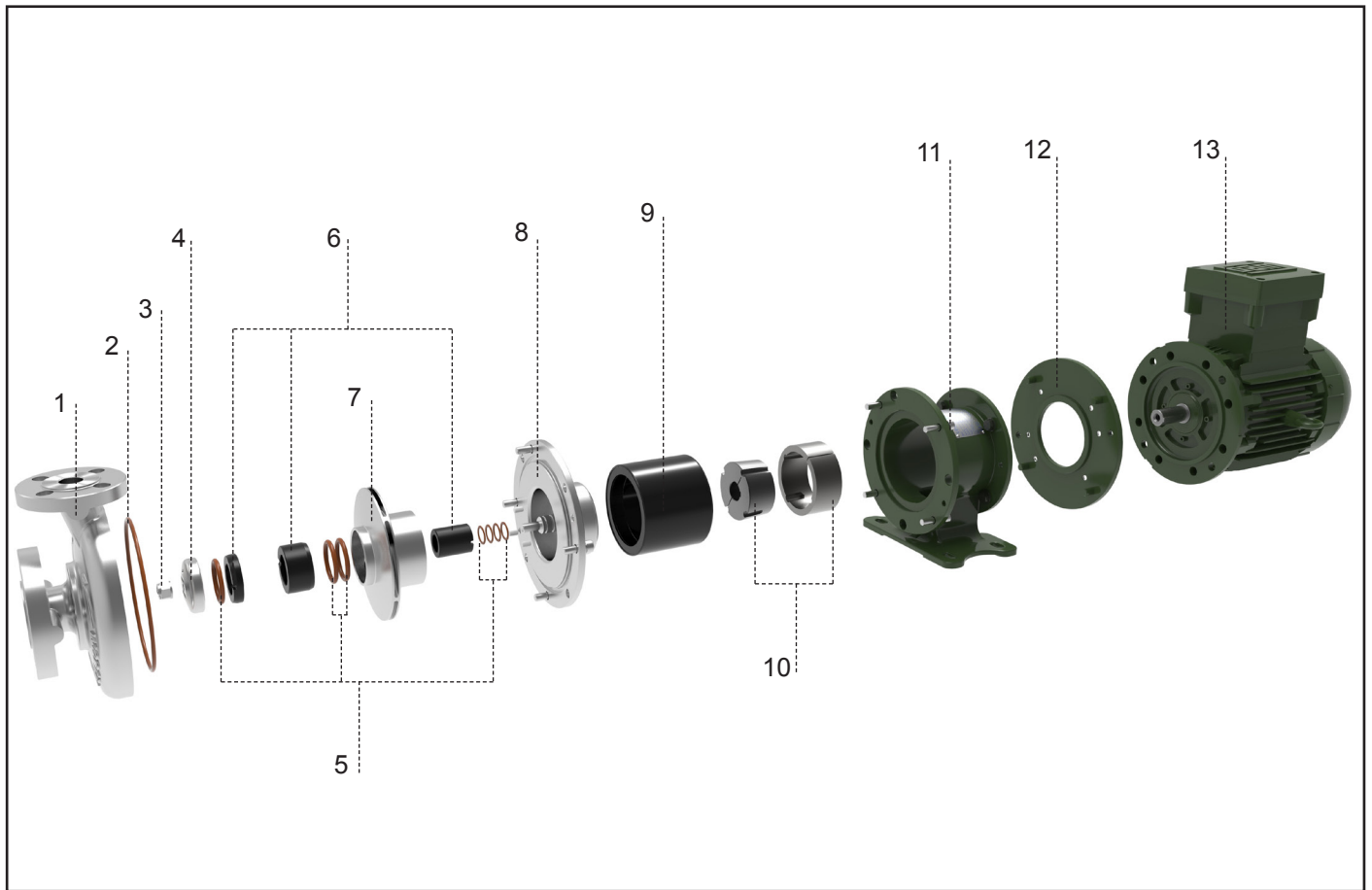

Figure 5 Verdermag® PC160 Exploded View (generic view)

1	Casing	5	O-Ring Kit	9	Outer Rotor Assy
2	Casing O-Ring	6	Front Bearing Assy	10	Taper Lock Bush Assy
3	Impeller Locknut	7	Impeller Assy	11	Pedestal
4	Bearing Holder	8	Back Plate Assy	12	Transition Flange
				13	Motor

5 ATEX Specification

1. The ATEX code consists of the group, category, ignition protection marking and temperature class.
2. ATEX rating of Verdermag® Global Centrifugal pumps is to the following standard which is explained below:

Ex h IIB T4 Gb / Db

Item	Example	Explanation
Protection Concept	h	Non-Electrical Equipment meeting the requirements of EN ISO 80079-36:2016 is marked with "h".
Gas Group	IIB	Gas Group II - Ethylene
Dust Group	IIIB	Dust Group III, Non-Conductive Dust
Temperature Class (Example)	T4	Maximum surface temperature 135 °C
Equipment Protection Level	Gb and Db	Equipment Protection level: Gb: Gas zone 1 Db: Dust zone 21

Table 4 ATEX Gas/Dust Classification

5.1 Gas/Dust Group

 Gases are classified according to type of hazardous environment and ignitability of the gas/air mixture as defined in EN/IEC 60079-21-1.

Gas Group	I	Mines
	II	Surface above ground with gas hazard
Dust Group	III	Surface above ground with dust hazard
Gas Sub Group	A	Less easily ignited gases e.g. propane
	B	Easily ignited gases e.g. ethylene
	C	Most easily ignited e.g. hydrogen or acetylene

Table 5 Gas/Dust Group

5.2 ATEX Zones

 Zones are decided by the site based on a risk assessment of the likelihood of a potentially explosive atmosphere being present.

Gas Zone	EPL	ATEX Zones
Zone 0	Ga	Explosive atmosphere present continuously or for long periods, frequently
Zone 1	Gb	Explosive atmosphere is likely to occur under normal conditions, occasionally
Zone 2	Gc	Explosive atmosphere is unlikely to occur under normal conditions, short periods

Table 6 ATEX Zones - Gas

Dust Zone	EPL	ATEX Zones
Zone 20	Da	Explosive atmosphere present continuously or for long periods, frequently
Zone 21	Db	Explosive atmosphere is likely to occur under normal conditions, occasionally
Zone 22	Dc	Explosive atmosphere is unlikely to occur under normal conditions, short periods

Table 7 ATEX Zones - Dust

5.3 Temperature Class

 The Temperature Class rating of T1, T2, T3 or T4 for gases, indicates the classification for the maximum surface temperature for the device and therefore the distance to the potential ignition temperature for a particular gas.

T Class ¹	Maximum Surface Temperature (ATEX) ³	Maximum Pumped Liquid Temperature (ATEX) ²
T1 ⁵	450°C	360°C
T2 ⁵	300°C	240°C
T3	200°C	160°C
T4	135°C	108°C
T5 ⁴	100°C	80°C
T6 ⁴	85°C	68°C

- 1 The temperature class rating (T class) of the pump is determined by the temperature of the process fluid being pumped.
- 2 The maximum pumped liquid temperature (T_{pmax}) is 20% below maximum surface temperature.
- 3 $T_{pmax} = \text{Maximum Surface Temp} - 20\%$
e.g (T4) 135°C - 20% (27°C) = 108°C
- 4 Note if the pump needs to meet T5 or T6 applications, please contact Verder Tech Support.
- 5 Care Point: 'T-max' Limited by Material Selection. (refer to → 5.3.1)

Table 8 Temperature Class

5.3.1 'T-max' Limited by Material Selection

 Depending on application (T1 & T2 gas classes in particular) T-max may be reduced due to the temperature limits of the pumps individual parts of construction. Then the maximum allowable surface temperature (T-max) will be stipulated on the pump label instead of an actual Temperature Class. Similarly, this is the case in dust (D) protection applications (refer to → 5.3.2)

5.3.2 Dust (D) Protection: Maximum Allowable Temperature

 T-max (Dust) is determined by the lowest temperature from the following points:

	Maximum Allowable Surface Temperature (T-max)
Dust Layer	¹ T-5mm minus 75°C
Dust Cloud	² 0.66 x T-cl
Material Selection Limits	The pumps individual parts of construction temperature limits.

¹ T-5mm is the ignition temperature of a dust layer of 5mm thickness.

² T-cl is the ignition temperature of the dust cloud.

5.4 Non-Electrical Protection Concept (h)

 In environments with an explosive atmosphere, ignition protection categories serve to prevent ignition by not reaching high temperatures. The ignition protection categories are distinguished according to the type and function of the equipment and the probability an explosive atmosphere will occur.

The ignition hazard assessment identifies sources of ignition and these can then be dealt with in turn, through compliance with EN ISO 80079, (→ refer to “Ignition Hazard Assessment” document provided as part of the ATEX pack for full details of compliance).

Ignition Hazard		Measures Applied to Prevent the Ignition Source Becoming Effective		
Potential Ignition Source	Description / Basic Cause (which causes originate which ignition hazard)	Reason for Assessment	Description of the Measure Applied	Basis Citation of Standard Technical Rules
Hot Surface	– Losses dissipate into heat.	The pump has a maximum temperature during normal operational conditions.	<ul style="list-style-type: none"> ▶ Maximum temperature achieved during testing. ▶ Test results recorded. ▶ Limitations on medium temperature and Maximum permitted pump speed. ▶ Under normal operation the max pumped liquid temperature will be the limiting factor determining the 'T' rating of the pump (T rating will be approx 20% above the of maximum pumped liquid temperature.) ▶ The calculated 20% reduction in max fluid temp is to allow for any malfunctions where heat increases would occur, such as de-coupling of magnets before the safety measures such as power & flow monitors activate to stop the pumping process 	EN 80079-36:2016 6.2 EN 80079-36:2016 8.2 EN 80079-36:2016 10
	– Excess pressure - discharge – Operating outside of specified environmental conditions	Exceeding operating temperature.	<ul style="list-style-type: none"> ▶ Comply with specifications. 	EN 80079-36:2016 10 EN 80079-37:2016 5
	– Bearing wear	Exceeding operating temperature.	<ul style="list-style-type: none"> ▶ Bearing wear is dependent on several factors e.g. number of starts (running hours) volume and size of solids being pumped and increased temperature. ▶ Guidance in the instructions will recommend maintenance periods and maximum permissible bearing wear. ▶ User to monitor. 	EN 80079-36:2016 10 EN 80079-37:2016 5
	– Dust collection on horizontal/flat surfaces	May cause over temperature	<ul style="list-style-type: none"> ▶ Unlikely on pump casing, pedestal & motor because of their geometry (mostly horizontal cylinders). ▶ Regular maintenance to help ensure all surfaces remain clean. 	EN 80079-36:2016 10

Table 9 Ignition Protection (continued)

Ignition Hazard		Measures Applied to Prevent the Ignition Source Becoming Effective		
Potential Ignition Source	Description / Basic Cause (which causes originate which ignition hazard)	Reason for Assessment	Description of the Measure Applied	Basis Citation of Standard Technical Rules
Mechanical Sparks	– External impact, mechanical failure	Potential impact from other source, falling object, been struck by moving object. (Causing 'thermite' spark)	<ul style="list-style-type: none"> ▶ External materials are stainless steel casings and a paint protected mild steel pedestal - having less than 125J impact energy. ▶ No aluminium, magnesium or titanium or similar is present on the externals of the pump assembly. ▶ End user to ensure sufficient protection from falling and moving objects is provided (covers and cowlings). 	EN 80079-36:2016 6.4.2.1
Electrical Equipment/ Sparks	– Electric motor inside the assembly	Electrical equipment is a possible ignition source	<ul style="list-style-type: none"> ▶ Only electrical equipment with certification of ATEX conformity is used (ATEX motors fitted with PTC safety feature as standard.) 	IEC 60079 series
Stray Electrical, Currents and Cathodic Corrosion Protection			<ul style="list-style-type: none"> ▶ No stray currents or cathodic corrosion. 	EN 80079-36:2016 6.6
Static Electricity	– Electrostatic discharge	'Isolated conductive parts can create a 'capacitor' which can be charged by electrostatic induction to create a hazardous static condition	<ul style="list-style-type: none"> ▶ All isolated electrical conductive parts will have equipotential bonding between affected parts i.e. all external mating front covers, casings, pedestals, motors and mounting plates will be 'earthed'. The standard coating applied to external parts is non-metallic 2 pack epoxy paint, ▶ Its normal 'dry' thickness is 40 microns (therefore it does not exceed the 2mm maximum thickness allowed when non-conductive material is a coating on an earthed metal.) 	EN 80079-36:2016 6.7.5
Lightning	– Lightning strike		<ul style="list-style-type: none"> ▶ End user to assess and protect equipment accordingly 	EN 80079-36:2016 10
Electromagnetic Waves			<ul style="list-style-type: none"> ▶ Not relevant 	
Flames, Hot gases			<ul style="list-style-type: none"> ▶ Not relevant 	
Ionising Radiation	– Pump situated in a radioactive environment		<ul style="list-style-type: none"> ▶ Not relevant, pump NOT approved for use in a radioactive area 	EN 80079-36:2016 10
High Frequency Radiation			<ul style="list-style-type: none"> ▶ Not relevant 	

Table 9 Ignition Protection (continued)

Ignition Hazard		Measures Applied to Prevent the Ignition Source Becoming Effective		
Potential Ignition Source	Description / Basic Cause (which causes originate which ignition hazard)	Reason for Assessment	Description of the Measure Applied	Basis Citation of Standard Technical Rules
Ultrasonic			▶ Not relevant	
Adiabatic Compression			▶ Not relevant	
Chemical Reaction	– Pumped media incompatible with pump materials	Seals failure	<ul style="list-style-type: none"> ▶ Pumped liquid must be chemically compatible with the materials of construction. ▶ Chemical attack on the O-rings may affect the bearings support and cause premature failure. ▶ End user/ sales applications engineer to ensure awareness of pump construction and compatibility of seal material with pumped media. 	EN 80079-36:2016 10
Mechanical strength	– Excess pressure	Over Pressure in containment tube too high	▶ Comply with specifications	EN 80079-36:2016 10 EN 80079-37:2016 5 EN 80079-37:2016 6
	– Impeller failure	Exceeding operating temperature/bearing failure	▶ Comply with specifications	EN 80079-36:2016 10 EN 80079-37:2016 5 EN 80079-37:2016 6
	– ‘Dry Running’: Operating the unit without liquid in the pump	Exceeding operating temperature/bearing failure	<ul style="list-style-type: none"> ▶ ‘Dry running’ will give rise to increased bearing surface temperatures and if prolonged may lead to early bearing failure. ▶ Prevent by user instructions. ▶ User to monitor power, flow and temperature levels. 	EN 80079-36:2016 10 EN 80079-37:2016 5 EN 80079-37:2016 6
	– Pumping against a closed valve	Exceeding operating temperature/bearing failure	<ul style="list-style-type: none"> ▶ Running the pump against a closed valve will prevent adequate flow around the magnets and bearings leading to over temperature and possible bearing failure. ▶ Prevent by user instructions and power/flow monitoring. ▶ Refer to manufacturers recommended installation instructions 	EN 80079-36:2016 10 EN 80079-37:2016 5 EN 80079-37:2016 8.2
	– Operating above maximum safe flow	Exceeding operating temperature/bearing failure	<ul style="list-style-type: none"> ▶ Operation at increased flow rates (above those recommended) may result in the build-up of eddy current heat resulting in a rise in temperature. ▶ It may also cause a rise in vibration, both leading to bearing failure. ▶ Prevent by user instructions and power monitoring 	EN 80079-36:2016 10 EN 80079-37:2016 5 EN 80079-37:2016 8.2

Table 9 Ignition Protection (continued)

Ignition Hazard		Measures Applied to Prevent the Ignition Source Becoming Effective		
Potential Ignition Source	Description / Basic Cause (which causes originate which ignition hazard)	Reason for Assessment	Description of the Measure Applied	Basis Citation of Standard Technical Rules
Mechanical strength	– Operating below minimum safe flow	Exceeding operating temperature/bearing failure	<ul style="list-style-type: none"> ▶ Operation at reduced flow rates (below those recommended) may result in the build-up of eddy current heat resulting in a rise in temperature. ▶ It may also cause a rise in vibration, both leading to bearing failure. ▶ Prevent by user instructions and power/flow monitoring 	EN 80079-36:2016 10 EN 80079-37:2016 5
	– Excessive Bearing wear leading to Bearing failure	Exceeding operating temperature/bearing failure	<ul style="list-style-type: none"> ▶ Bearing wear guidance in the instructions/manual recommends maintenance periods and maximum permissible wear. ▶ Operating beyond these limits may lead to contact of rotating parts and/or bearing failure caused by dry running. ▶ Pumping against a closed valve, excessive cavitation, O-ring failure, oversized or volume of solids passing through the pump leading to localised heat (above the temperature class) or jamming of the internal rotating assembly leading to de-coupled magnet operation. ▶ Prevent my user instructions, monitoring the pump condition and regular maintenance. 	EN 80079-36:2016 10 EN 80079-37:2016 5
	– Oversized solids passing through pump	Exceeding operating temperature/bearing failure	<ul style="list-style-type: none"> ▶ Maximum size of occasional particle is 0.5mm dia. ▶ This size particle should not be the normal content of the liquid. ▶ Larger particles will lead to the damage of parts -i.e. bearing, impeller and seals. ▶ End user/ sales applications engineer to ensure correct pump selection. 	EN 80079-36:2016 10 EN 80079-37:2016 5

Table 9 Ignition Protection (continued)

Ignition Hazard		Measures Applied to Prevent the Ignition Source Becoming Effective		
Potential Ignition Source	Description / Basic Cause (which causes originate which ignition hazard)	Reason for Assessment	Description of the Measure Applied	Basis Citation of Standard Technical Rules
Mechanical strength	– Excessive volume of solids passing through the pump.	Exceeding operating temperature/bearing failure	<ul style="list-style-type: none"> ▶ Maximum slurry particle size is 250µ at no more than 5% by pumped volume. ▶ All solids will increase the wear rate of the bearings, for this reason maintenance periods should be adjusted to suit. ▶ Prevent by user instructions on pump limitations and the need for sales applications engineer to ensure correct pump selection. 	EN 80079-36:2016 10 EN 80079-37:2016 5
	– Blockage of flow holes	Exceeding operating temperature/bearing failure	<ul style="list-style-type: none"> ▶ Build-up of material on the walls of the flow holes will eventually lead to blockage and poor flow circulation. ▶ If unchecked may result in increased temperature and bearing failure. ▶ End user to monitor ensure regular maintenance periods. 	EN 80079-36:2016 10 EN 80079-37:2016 5
	– De-coupled operation	Exceeding operating temperature/bearing failure/severe damage	<ul style="list-style-type: none"> ▶ De-coupled operation occurs when the outer magnet breaks away from the internal magnet (often caused by a foreign body entering the pump and jamming against the impeller - stopping it from rotating) . ▶ Causing the internal magnet to remain stationary whilst the outer magnet continues to rotate. ▶ The internal magnet is then subjected to rapid changes from attraction to repulsion, causing vibration and a build-up in eddy current heat. ▶ If unchecked this will cause severe damage leading to an increase in temperature resulting in bearing failure. ▶ End user to monitor power, flow and any increase in temperature. 	EN 80079-36:2016 10 EN 80079-37:2016 5
	– Damage to impeller from pumped media	May cause over temperature	<ul style="list-style-type: none"> ▶ End user/sales applications engineer to ensure compatibility of impeller to pumped media 	EN 80079-36:2016 10 EN 80079-37:2016 5

Table 9 Ignition Protection (continued)

Ignition Hazard		Measures Applied to Prevent the Ignition Source Becoming Effective		
Potential Ignition Source	Description / Basic Cause (which causes originate which ignition hazard)	Reason for Assessment	Description of the Measure Applied	Basis Citation of Standard Technical Rules
Mechanical strength	– Metal contact of rotating assembly with the casing of the containment tube	Bearig wear may cause over temperature	<ul style="list-style-type: none"> ▶ The manufacturing clearances in the pump (even with the ‘worst case’ tolerance stack-up do not permit contact. ▶ Providing that any bearing wear does not exceed the permitted allowances. ▶ Alternatively, excessive bearing wear or bearing failure will lead to metal on metal contact, with a subsequent heat build-up. ▶ End user to perform regular inspection/maintenance checks 	EN 80079-36:2016 10 EN 80079-37:2016 5
	– Failure of motor bearing	Exceeding operating temperature/bearing failure/severe damage	<ul style="list-style-type: none"> ▶ Failure of the motor bearings can lead to the outer magnet catching on the pedestal causing localised heating of parts. ▶ ATEX certified motor to be used. ▶ End user to perform regular inspection/ maintenance checks. 	EN 80079-36:2016 10 EN 80079-37:2016 5
	– Running the pump in the reverse/wrong direction (correct direction arrow shown on front cover)	Exceeding operating temperature/bearing failure	<ul style="list-style-type: none"> ▶ The pump will not operate at the expected performance. ▶ Poor fluid circulation will occur leading to an increase in temperature and possible bearing failure. ▶ End user to ensure that the pump motor is wired up correctly by a qualified electrician and monitor start-up 	EN 80079-36:2016 10 EN 80079-37:2016 5

Table 9 Ignition Protection

6 Installation and Connection

NOTE

Material damage due to unauthorized modification on pump!

- ▶ Do not make any structural modifications to the pump or pump casing
- ▶ Do not carry out any welding work on the pump or pump casing

NOTE

Material damage caused by ingress!

- Do not remove any protective flange covers until immediately before connecting the pipes to the pump



The magnets used to drive the pump are very powerful. Care should be taken when handling both the outer and inner magnets during disassembly and assembly.

Completely close both discharge and suction valves before assembly. Be very careful when pumping corrosive liquids. There may be a residue in the pump even after flushing.

6.1 Preparing for Installation

6.1.1 Checking the Ambient Conditions

1. Make sure that the operating conditions are in accordance with the pump specifications
2. Make sure the required ambient conditions are fulfilled (→ Appendix A - 12.2 Ambient conditions)

6.1.2 Preparing the Installation Site

- ▶ Ensure the installation site meets the following conditions:
 - Pump is freely accessible
 - Sufficient space is available for the installation/removal of the pipes and for maintenance and repair work.

6.1.3 Preparing the Foundation and Surface

- ▶ Make sure the foundation and surface meet the following conditions:
 - Level
 - Clean (no oil, dust or other impurities)
 - Capable of bearing the weight of the pump and all operating forces
 - Ensure the pump is anchored securely at all required locations

- ▶ The pump set should ideally be mounted on a level horizontal steel base. The base should be of sufficient rigidity to prevent flexing. When bolting the pump down, insert shims as necessary under the pump feet to level the pump using a spirit level on the suction and discharge flanges of the pump. Use all available holes to mount the pump to the base.

6.2 Planning the Pipes

NOTE

Excessive length and sharp changes in the direction of flow may lead to flow instability and cavitation.

The suction piping should be as short as possible and with a minimum number of long radius bends and other restrictions.

1. The available NPSH should exceed the required NPSH at least 0,5 m. See respective applicable performance curve for the required NPSH.
2. The suction piping should never be smaller than the pump inlet. When pumping viscous or hot liquids, lower flow velocities, and larger pipe diameters are recommended.
3. Reduction of the diameter is not recommended due to the high pressure created at the pump discharge.
4. Mate the pump to the connecting pipework ensuring the pipework is supported independently eliminating any tremors, weight or vibration transmitted from connecting piping to the pump.
5. When pumping extremely aggressive or dangerous liquids, it is recommended to have a vent to the storage tank. We would strongly advise that in these circumstances you install a discharge and suction valve.

6.3 Electrical Connection



Risk to health due to electric shock!

All electrical work must be carried out by qualified electricians.

1. Connect the motor to the rated power supply. Ensure the correct gland is used and that the earth connection is made and secured.
2. Make sure the motor's direction of rotation is correct.

6.3.1 Connecting to a Power Supply



Isolate power supply from the pump before performing the installation.

1. The pump must be installed by a qualified individual.
2. The impeller must be turned by hand to ensure free rotation.
3. The motor cover and cable inlet must be checked for visible damage.
4. Check rotational direction.

7 Commissioning and Operation

7.1 Pre-commissioning the Pump



Pumped Medium

The pump may only be operated using the medium specified in the data sheet. The materials used to build the pump are compatible with this medium. (→ Appendix A)

1. Fully clean the inside of the piping and the pump prior to priming.
2. Retighten the flange connecting bolts and base mounting bolts. If possible, pressure test your installation.
3. Use the motor fan to turn the motor and check whether or not it turns freely.
4. Completely close the discharge valve.
5. When the suction condition is under pressure, check the pressure within the suction pipe, and verify that the pump is filled with liquid. Then using the motor fan, rotate the pump to expel the remaining air in the impeller from the pump chamber.
6. Verder recommends the use of a power monitor to prevent pump damage and inefficiency if for example, a pipe is blocked, a valve is not fully open or the pump is running dry.

7.1.1 Checking the Direction of Rotation

- Ensure the pump is not run dry.
- Check the power supply with the information on the tag-plate of the motor and set the thermal safety guards, in accordance with the instructions provided by the motor supplier.
- Switch the motor on and check the direction of rotation; switch immediately off again.
- If the direction of rotation is wrong - turn the pump off immediately and have a qualified electrician check that the motor is 'wired-up' correctly.

7.1.2 Checks for ATEX Explosion Hazard Zone



- Ensure that the entire assembly and its constituent parts have been certified/approved for the ATEX explosion hazard zone in which it will be operating.
- ATEX certified 'bare-shaft' pumps (pump units supplied without a motor.) End user to ensure that the motor eventually fitted onsite is approved/certified and correctly labelled for the ATEX explosion hazard zone in which it will be operating in accordance with ATEX 114.
- The maximum allowable speed is shown on the pump I.D. plate and in the pump data sheet. If the pump is operated at a speed exceeding that specified – the pumps ATEX certification will become invalid.

- In an ATEX explosion hazard zone, where possible the pump should be located/positioned so that it will be protected from impacts by foreign bodies – i.e. falling and moving objects.
- Prior to operating the pump with an 'Add-on' frequency converter unit. Ensure that the driving motor is suitable for the application and that the frequency converter is ATEX certified for the explosion hazard zone in which it will be installed.
- When operating the pump, the end user must ensure that the pump runs completely 'filled', if not, an ignition source could develop due to excessive heat. When operating in an ATEX explosion protection zone the pump must be completely filled with fluid.
- In an ATEX explosion hazard zone, to avoid bearings over heating or collapsing and becoming a possible ignition source, the bearings must be maintained according to the instructions given in the manual (→ 8.2.1 Bearing Wear Chart)
- Dust collection on flat surfaces. In an ATEX explosion hazard zone a build-up of dust on the pump unit can cause an increase in temperature. Regularly wipe down/brush away any excessive dust deposits. End user to monitor.
- To avoid static discharge all pump units isolated electrical conductive parts will have equipotential bonding applied during manufacturing/assembly, i.e. the pump front cover, casing pedestal and motor will be 'earthed', end user must ensure that the pump unit together with any mounting base plate (if used) must be correctly earthed during commissioning prior to operation.
- End user to be aware that the use/application of non-metallic paint coatings can lead to electrostatic ignition risks.

NOTE

The pump unit as supplied meets the required coating standards to negate the risk of electrostatic ignition risk, per BS EN ISO 80079-36:2006: (CLAUSE 6.7.5)

7.2 Commissioning the Pump

DANGER

Risk of injury and poisoning due to pumped liquid spraying out!

- ▶ Use personal protective equipment when carrying out any work on the pump.

Equipment damage due to excess pressure!

- ▶ Do not operate the pump with the discharge-side fitting closed.
- ▶ Operate the pump only inside the tolerances specified by the pump manufacturer (→ Appendix A - 12 Technical Specifications).

WARNING

Risk of injury and poisoning due to hazardous pumped liquids!

- ▶ Safely collect any leaking pumped liquid and dispose of it in accordance with environmental rules and requirements.

Checklist:

- Pump set up and connected properly.
- Motor set up and connected properly.
- All connections stress-free and sealed.
- All safety equipment installed and tested for functionality.

1. Close the cocks of the pressure and vacuum gauges. Open the cocks only when measuring and always keep closed after use.
2. Fully open the suction side gate valve and partly open the valve on the discharge line.
3. Before starting up, ensure that the piping and wiring are installed correctly.
4. Turn the motor fan by hand and ensure that the pump rotates smoothly. Operate for a few seconds to check that the motor is rotating in the correct direction. An arrow shown on the pump indicates the correct rotating direction. If rotation is incorrect, interchange power source leads of 2 phase terminals.
5. Start the pump. If the pump fails to start, check the wiring to determine the cause of the trouble.
6. Check the discharge pressure and then gradually open the gate valve until the pressure reaches the required level. When the valve is opened too quickly, it may cause overload and magnet de-coupling.
7. Check that the required flow rate is obtained. Ensure that minimum safe flow requirements are exceeded. Do not close the valve excessively. If a flow meter is not installed, obtain the required flow from the values of pressure gauges, ampere meter and friction head loss.
8. Ensure the pump is not run dry or against a closed valve.
4. Run the pump, flushing with water first (cold commissioning) to check for leaks.
5. Verify that neither the pump nor the pipe connections are leaking.
6. Perform a second flush by running the pump, 10–20 revolutions with pumped liquid, to remove residue and water inside the pump.

7.2.1 Notes for Commissioning the Pump in ATEX Explosion Hazard Zone



1. In an ATEX explosion hazard zone, to prevent the pump from overheating it must not be operated against a closed (downstream) control valve during start-up. The downstream control valve must be opened enough to ensure that at least the minimum specified amount of flow is achieved. End user to monitor.
2. When first operating the pump. Run the unit for 1 to 2 hours under normal conditions – checking for anything unusual (i.e. excessive noise, vibration and monitoring for higher surface temperatures than those specified for that particular ATEX rated pump)
3. Very rarely, during start-up acceleration, de-coupling (break-away of the magnetic drive) may occur. This condition can be detected by monitoring the ‘delivery head’, ‘capacity’ and ‘pump output power’. Continued operation of a ‘de-coupled’ magnet drive can cause excessive temperatures exceeding those specified for that particular ATEX rated pump. End user to be aware and monitor on start-up.

7.3 Notes for Operation

To be avoided	Measure
Dry Running	▶ Dry running must be avoided. Before operating, make sure that the pump is primed and vented. Pumping temperature / pressure should ensure the pumped product remains in the liquid phase at all times.
Cavitation	▶ Cavitation damages the internal pump parts, such as bearing and impeller, or can cause abnormal wear; therefore the pump should be stopped immediately under cavitation running. Do not close the suction gate valve while the pump is in operation.
Disassembly of Magnet Coupling	▶ If the magnet coupling becomes disconnected due to overload, or another reason, stop the pump immediately. If the pump is operated for long periods under this condition, magnet and bearing damage will occur.
Variation in Liquid Temperature	▶ If the temperature of the liquid varies over the limits of your pump, damage may occur. For specific data on your pump, please see maintenance manual.
Electrical Failure	▶ When the electric power supply fails, cut the supply to the pump at once and close the discharge valve.
Maximum permissible system pressure	▶ Ensure the system pressure does not exceed the pressure capabilities of the pump.

Table 10 Notes for Operations

7.3 Notes for Operation (continued)



CAUTION



Failure to operate the pump unit within the specified parameters may result in a 'rare malfunction' / giving rise to the possibility of an effective source of ignition

Refer to ATEX certificate of conformity and "Ignition Hazard Assessment" document provided as part of the ATEX pack for full details of compliance.

The ATEX certification only applies to the pump head and should be applied in conjunction with the motor certification (not applicable to pump units installed in non-hazardous areas).

7.3.1 Switching ON the Pump



DANGER

Risk of injury due to running pump!

- ▶ Do not touch the moving parts of a running pump.
- ▶ Do not carry out any repair/ maintenance work on the running pump.
- ▶ Allow the pump to cool down completely before starting any work on the unit.

Risk of injury and poisoning due to pumped liquid spraying out!

- ▶ Use personal protective equipment when carrying out any work on the pump.

Note

Risk of pulsation when throttling down the suction flow rate!

- ▶ Fully open the suction-side fitting and DO NOT use it to adjust the flow.

Checklist:

- Pump pre-commissioned. (→ 7.1 Pre-commissioning the Pump)
 - Pump prepared and filled.
1. Open the suction-side and the discharge-side fittings.
 2. Switch on the motor and make sure it is running smoothly.

7.3.2 Switching OFF the Pump



WARNING

Risk of injury due to hot pump parts!

- ▶ Use personal protective equipment when carrying out any work on the pump.

Note

Damage to pump due to sediments!

- ▶ If the pumped liquid crystallizes, polymerizes or solidifies
 - Flush the pump
 - Make sure that the flushing liquid is compatible with the pumped liquid.

7.4 Shutdown and Removal / Storing the Pump over Longer Periods

1. The parts that come into contact with the pumped medium are to be cleaned and neutralised if necessary.
2. Refer to the storage conditions. (→ 3.2 Treatment for storage)

7.5 Shutdown Without Removal Over Longer Periods (On-Site Preservation)

1. Rinse, and neutralise if necessary, the pump section between the valves.
2. Make sure the pump is drained completely.
3. For long term storages pumps should be rotated by hand at least five revolutions every two months.

8 Inspection, Maintenance and Repairs

DANGER

- ▶ Do not carry out any repair/maintenance work on a pump whilst running.
- ▶ Follow the safety procedures for handling the product being pumped.
- ▶ Ensure when the pump has been operated at extremes of temperatures that it has reached safe limits before handling.
- ▶ Decontaminate before handling as per local safety regulations. If dangerous or unknown substances have been used in the pump prior to maintenance and repair work, always clean the pump first. This can be achieved by using a drain plug if present or the pumps can be flushed using a product which will not react with either the components inside the system or the fluids present.
- ▶ Appropriate measures must be taken to relieve any pressure build up.
- ▶ Gradually close the discharge gate valve. Never close the discharge piping suddenly (e.g. by use of a solenoid valve).
- ▶ Shut off the electrical supply monitor if the speed of rotation falls slowly and smoothly.

Risk of electrocution!

- ▶ Have all electrical work carried out only by qualified electricians.

8.1 Inspections

 The inspection intervals depend on the pump operating cycle.

1. Check at appropriate intervals:
 - No changes in operating conditions, discharge and suction pressure, flow rate, vibration, voltage, noise and the electric motor current
 - Lubrication schedule for bearings (use on long coupled pump only). In those cases where the bearings are not greased for life, see manufacturers' recommendations.
2. For trouble-free operation, always ensure the following:
 - No leaks
 - No unusual running noises or vibrations
 - Temperature is stable

8.2 Maintenance

 VERDER LTD offers customers a service contract, which covers maintenance and repairs to the pump. Contact Customer Service, to request a non-binding offer.

8.2.1 Cleaning the Pump

Make sure that no cleaning agent contaminates the pump bearings and motor.

- ▶ Cover all parts that should not come into contact with cleaning agent.
- ▶ Never spray cold liquids such as water on hot pump parts. The casing may crack if it cools too quickly and may render the pump unusable.
- ▶ Remove any build-up of material on the walls of the flow holes to ensure correct flow and circulation.

NOTE

Contact VERDER LTD. before you use a liquid cleaning agent and confirm that the product that you intend to use is safe. The operator must ensure that the product is safe to use with the pumped medium.

- ▶ Select a suitable method for cleaning the electrical material and consult a qualified electrician.

8.2.1 Bearing Wear Chart

The bearing sets, material silicon carbide must be replaced when:

Part no	Nominal	Replacement
SCB.1 (E4)	20.0mm	Sleeve OD -0.1mm on Ø wear Bush ID +0.2mm on Ø wear
SCB.2 (E3)	25.0mm	
SCB.3 (E1)	38.0mm	
SCB.4 (E2)	50.0mm	

Table 11 Bearing Wear Chart

8.3 Repair



DANGER

Risk of death due to electric shock!

- ▶ Have all electrical work carried out by qualified electrician only.



WARNING

Risk of injury due to heavy components!

- ▶ Pay attention to the component weight. Lift and transport heavy components using suitable lifting gear.
- ▶ Set down components safely and secure them against overturning or rolling away.

Risk of injury while dismantling the pump!

- ▶ Use protective equipment when carrying out any work on the pump. Do not trap your fingers between magnetic parts because of its high power.
- ▶ Observe manufacturer's instructions (e.g. for Motor, coupling, gearbox).

8.3.1 General Disassembly/Assembly

Checklist:

- Ensure the pump is isolated from the power supply.
- Remove the pump from the pipework installation.
- The pump will hold a small amount of product and will drain on removal of the casing. Care must be taken if this product is hazardous to health.
- The magnetized components, i.e. the pump shaft assembly and the outer rotor assembly must be clean and free of all debris.
- All threaded components must be coated with anti-seize compound such as copper slip or pcb.
- New sealing joints should be fitted.
- The unit must be assembled in a clean area.

NOTE

The inner and outer rotors are magnetic and will attract debris. They must be protected at all times.

8.3.2 Returning the Pump to the Manufacturer

Obtain prior authorization before repair or return of the pump.

- ▶ When returning used pump units, they must be accompanied by the relevant COSHH data and completed copy of the returns documentation. Failure to supply information can lead to any pumps being delivered to be disposed of at the user's cost.
- ▶ Please contact the manufacturer for return of goods form.

8.4 Ordering Spare Parts

For trouble-free replacement in the event of faults, we recommend keeping spare parts available on site.

- ▶ The following information is mandatory when ordering spare parts (→ Name plate):
 - Pump model
 - Year of manufacture
 - Part number / Description of part required
 - Serial number
 - Quantity

9 Troubleshooting

9.1 Pump malfunctions

If malfunctions occur which are not specified in the following table or cannot be traced back to the specified causes, please consult the manufacturer.

Possible malfunctions are identified and respective cause and remedy are listed in the table.

Malfunction	Potential Cause	Recommended Solution
Pump Vibrates	▶ Incorrect mounting	▶ Secure mounting
	▶ Drive Magnet broken	▶ Replace
	▶ Motor bearing worn	
	▶ Incomplete foundation	▶ Make proper foundation
	▶ Mounting bolts are loose	▶ Retighten them
	▶ Cavitation exists	▶ Remove the cause of cavitation
	▶ Pump bearing shaft magnet capsule broken down or worn ▶ Drive magnet broken ▶ Motor bearing worn	▶ Replace with new one
Insufficient Discharge	▶ Pump rotates in reverse	▶ Change the motor connections
	▶ Insufficient pump rotating speed	▶ Inspect the motor and wiring
	▶ Suction pipe is clogged with foreign particles	▶ Clean the suction pipe
Motor is overheating	▶ Output is overpowered	▶ Inspect whether or not the S.G. and viscosity of the liquid in use are correct as per datasheet ▶ Check whether the voltage and frequency of the motor are correct
	▶ Ambient temperature is high	▶ Improve ventilation
When the Discharge value is lower than expected	▶ Magnet coupling is de-coupled	▶ Manually rotate the pump to check whether or not it runs smoothly.
	▶ Is the output overpowered?	▶ Measure the current. Check whether the voltage is within the rating
	▶ Air enters through the junction of suction pipe	▶ Inspect whether or not the junction of suction pipe is sealed ▶ Inspect the suction liquid level
No pumping achieved	▶ Suction pipe is clogged with foreign particles	▶ Clean the suction pipe
Liquid drops when discharge valve is opened after starting of pump	▶ Air is penetrating through suction pipe ▶ Disconnection of magnet coupling	▶ Check if flanges are sufficiently sealed ▶ Check if suction liquid level is abnormally low ▶ If motor fan does not rotate smoothly with a screwdriver, make sure that there is no foreign matter in pump and around pump bearing ▶ Check for overload and incorrect power voltage
Pointer of pressure gauge stays at low position and does not go up	▶ Rotation speed is low ▶ Impeller reverses	▶ Check power supply and motor ▶ Replace or correct wiring
Discharge capacity is too low. Foreign matter	▶ Strainer is clogged with foreign matter	▶ Remove foreign matter in strainer
Vacuum gauge indicates very high value	▶ Air pocket exists in suction pipe	▶ Check arrangement of suction pipe and adjust it properly
	▶ Foreign matter clogs the inlet of impeller	▶ Disassemble partially, then remove foreign matter
	▶ Air penetrates through suction line	▶ Check flanges are sufficiently sealed
	▶ Foreign matter clogs the discharge side of pump	▶ Remove foreign matter

Table 12 Troubleshooting (continued)

Malfunction	Potential Cause	Recommended Solution
Vacuum gauge shows high value, but pressure gauge shows normal value	▶ Air pocket exists in suction pipe	▶ Check if a rising part exists in suction line ▶ Clean suction pipe
Pressure gauge shows high value, while vacuum gauge shows normal value	▶ Total dynamic head is higher than planned values	▶ Check dynamic head including friction loss
Both pressure gauge and vacuum gauge show low value	▶ Direction of rotation is incorrect	▶ Change wiring arrangement
Motor is overheated	▶ Voltage drop	▶ Take necessary measures of voltage or frequency are incorrect
	▶ Overload	▶ Check if specific gravity and viscosity of the liquid are proper
	▶ Ambient temperature is too high	▶ If motor fan does not rotate smoothly with a screwdriver, make sure that there is no foreign matter in pump and around pump bearing ▶ Make draft condition better
Discharge capacity suddenly drops	▶ Strainer is clogged with foreign matter	▶ Remove foreign matter

Table 12 Troubleshooting

10 List of Figures and Tables

10.1 List of Figures

Figure 1	Lifting the Verdermag® Global Centrifugal Pumps	3.1.2
Figure 2	Turn the Shaft of the Impeller	3.2
Figure 3	Name Plate	4.3.1
Figure 4	ATEX Name Plate	4.3.2
Figure 5	Verdermag® PC160 Exploded View (generic view)	4.4.1

10.2 List of Tables

Table 1	Target Groups	1.1
Table 2	Warnings Used in the Manual	1.2
Table 3	Symbols Used in the Manual	1.2
Table 4	ATEX Gas/Dust Classification	5
Table 5	Gas/Dust Group	5.1
Table 6	ATEX Zones - Gas	5.2
Table 7	ATEX Zones - Dust	5.2
Table 8	Temperature Class	5.3
Table 9	Ignition Protection	5.4
Table 10	Notes for Operations	7.3
Table 11	Bearing Wear Chart	8.3.1
Table 12	Troubleshooting	9.1
Table 13	Declaration of Conformity	11

11 II 2GD EU Declaration of Conformity



<p>EU declaration of conformity according to machinery and ATEX directives</p> <p>We, VERDER Ltd., Unit 3 California Drive, Castleford hereby declare that the following machine adheres to the relevant EU directives detailed below:</p> <p>Designation Style 1, MKII, High System Pressure</p> <p>EU Directives:</p> <ul style="list-style-type: none"> • Machinery Directive (2006/42/EC) • Equipment intended for use in Potentially Explosive Atmospheres (ATEX) 2014/34/EU <p>Notified Body of Technical File Storage:</p> <ul style="list-style-type: none"> • SGS Baseefa 1180 Buxton UK <p>Applicable harmonized norms:</p> <ul style="list-style-type: none"> • ISO 80079-36 2016 • ISO 80079-37 2016 • EN 1127-1 and EN ISO 12100 <p>On behalf of Verder, I declare that on the date the equipment accompanied by this declaration was sold, the equipment conforms to all technical and regulatory requirements of the above listed directives.</p>		
<p>Manufacturer</p>	VERDER Ltd. Unit 3 California Drive Castleford WF10 5QH UK	
<p>Date: 01/06/2020</p>	<p>Company stamp / signature:</p>  <p>Anthony Beckwith Head of Development/Construction</p>	<p>Company stamp / signature:</p>  <p>Paul Storr Head of Quality</p>

Table 13 Declaration of Conformity

Appendix A

12 Technical Specifications

12.1 Pump Range Specifications

Size	Value	
Max. flow rate	Style 1	27 m3/h
	MKII	80 m3/h
	High System Pressure	80 m3/h
Max. differential pressure	Style 1	40 mwc (131 ft.wc)
	MKII	105 mwc (344.49 ft.wc)
	High System Pressure	105 mwc (344.49 ft.wc)
Temperature of pumped liquid	< 205 °C (401 °F)	
Dimensions	→ refer pump datasheet	

Table 1 Pump Range Specifications

12.2 Ambient conditions

 Operation under any other ambient condition would require approval from the manufacturer

Operating conditions

- Standard ambient temperature -20 °C to +40 °C (-4 to +104 °F)*
*Special units are available outside this range, see special application.
- Relative humidity (non-condensing) – long-term ≤ 85 %
- Setup height above sea level ≤ 1000 m (320 ft)

Storage conditions

- Ambient temperature +10 °C to +50 °C (+50 to +122 °F)
- Relative humidity (non-condensing) – long-term ≤ 85 %

12.3 Preservatives

 Use e.g. RUST-BAN 335 or similar preservatives on bare metal.

12.4 Pumped Media Limitations

-  1. Maximum size of occasional particle is 0.5mm dia.
2. Maximum slurry particle size is 250µ at no more than 5% by pumped volume.

13 Limitations for use in ATEX Environment

13.1 Speed Limitations

 The maximum allowable speed is shown on the pump I.D. plate and in the pump data sheet. If the pump is operated at a speed exceeding that specified – the pumps ATEX certification will become invalid.

13.2 Maximum Pressure

Pump Type	Maximum Range System Pressure BAR**
Style 1	16 BAR
MKII	16 BAR
High System Pressure	100 BAR

Table 2 Style 1, MKII, High System Pressure - Maximum Pressure

**These are maximum parameters for each range. Refer to the pump name plate for pump specific rating.

13.3 Maximum Temperature

 Refer to the pump specific name plate for the maximum temperature, especially for operation in ATEX environment.

13.4 Lightning Strike

 End user to take provision that pump will be protected against lightning strikes.

13.5 Ionising Radiation

 Pump is not approved for use in radioactive area. Standard, background radiation is permissible (< 50,000 Bq) Motor Protection.

13.6 Motor Protection

1. Motor must have PTCs fitted and correctly installed.
2. Motor must be protected by motor overload relays or equivalent.
3. Motor must be protected in event of overload condition.
4. 'Ex' motors for vertical mounting (shaft down) should be equipped with a Drip Cover (Impact Canopy) over the Fan Cowl.



13.7 Pumped Media

 The ATEX certification is only valid when pumping media that is approved by Verder. Using the pump with media that is not approved by Verder will make this certification void.
