



ELECTRIC BOREHOLE PUMPS  
*ELECTROPOMPES IMMERGEES*  
ELETTROPOMPE SOMMERSE

# E6 - 18

Poles  
*Pôles*  
Poli 2 50 Hz

**PolyPump Ltd**

Providing your pumping solutions

sales@polypump.co.uk  
01296 488 294

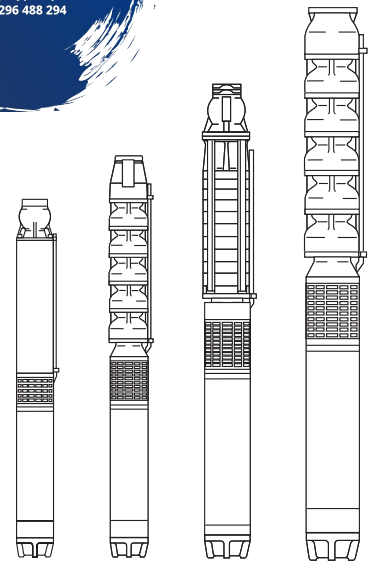

# caprari

pumping power

ISO 9001  
ISO 14001  
ISO 45001

BUREAU VERITAS  
Certification



	Page - Page - Pagina
Key to codes; <i>Explication des désignations</i> ; <b>Esemplificazione delle sigle</b>	3
Pump construction and materials; <i>Construction de la pompe et matériels</i> ; <b>Costruzione pompa e materiali</b>	4
Motor construction and materials; <i>Construction du moteur et matériels</i> ; <b>Costruzione motore e materiali</b>	14
General notes about the wet end; <i>Remarques générales partie hydraulique</i> ; <b>Note generali parte idraulica</b>	23
Motor general remarks; <i>Notes générales moteur</i> ; <b>Note generali motore</b>	24
Performance ranges; <i>Champs de performances</i> ; <b>Campi di prestazioni</b>	26
Operating data; <i>Caractéristiques de fonctionnement</i> <b>Caratteristiche di funzionamento</b>	27
Friction losses; <i>Pertes de charge</i> ; <b>Perdite di carico</b>	71
Overall dimensions and weights; <i>Dimensions d'encombrement et poids</i> ; <b>Dimensioni di ingombro e pesi</b>	73
Dynamic momentum of the wet end; <i>Moment dynamique partie hydraulique</i> ; <b>Momento dinamico parte idraulica</b>	80
Dynamic momentum of the motor; <i>Moment dynamique moteur</i> ; <b>Momento dinamico motore</b>	81
Feeding cables; <i>Câbles d'alimentation</i> ; <b>Cavi di alimentazione</b>	83
Maximum permitted current; <i>Courant maximum admissible</i> ; <b>Corrente massima ammissibile</b>	84
Max admitted length; <i>Longuer maxi admise</i> ; <b>Lunghezze massime ammissibili</b>	88
Generator power; <i>Puissance du generateur</i> ; <b>Potenza del generatore</b>	92
Common electric formulae; <i>Formules d'usage commun</i> ; <b>Formule di uso comune</b>	93
Electrical tolerances; <i>Tolérances électriques</i> ; <b>Tolleranze elettriche</b>	94
Reactive power compensation; <i>Compensation de la puissance reactive</i> ; <b>Compensazione della potenza reattiva</b>	95
Accessories; <i>Accessoires</i> ; <b>Accessori</b>	96
Technical data; <i>Donnes techniques</i> ; <b>Dati tecnici</b>	98

1) Electric pump code: - Désignation de l'électropompe: - Sigla elettropompa:

Ex. - Ex. - Es.

**E6P35/14M + MAC625A-8V**

**E6P55/19A + MAC650B-8V**

**E8R40N/11 + MAC850-8V**

**E10RB40N/14A + MAC10180A-8V**

2) Examples of wet end identification codes - Identification du sigle des partie hydraulique - Esemplificazione sigle parti idrauliche

**E6P35-6/14 M-V:**

**E.P** = Series - Série - Serie \_\_\_\_\_ **E 6 P 35 -6 /14 M -V**  
**6** = DN in inch - DN en pouces - DN in pollici \_\_\_\_\_  
**35** = Hydraulic identification number - Numéro identifiant hydraulique - Numero identificativo idraulica \_\_\_\_\_  
**-6** = Coupling flange motor - Bride d'accouplement moteur - Flangia accoppiamento motore \_\_\_\_\_  
**/14** = Number of stages - Nombre d'étages- Numero degli stadi \_\_\_\_\_  
**M** = Impeller trimming - Rognage roue - Riduzione girante \_\_\_\_\_  
**-V** = Unit used at 50 Hz - Ensemble avec utilization a 50 Hz - Gruppo con impiego a 50 Hz \_\_\_\_\_

**E6P55-6/19 A-V:**

**E.P** = Series - Série - Serie \_\_\_\_\_ **E 6 P 55 - 6 /19 A -V**  
**6** = DN in inch - DN en pouces - DN in pollici \_\_\_\_\_  
**55** = Hydraulic identification number - Numéro identifiant hydraulique - Numero identificativo idraulica \_\_\_\_\_  
**-6** = Coupling flange motor - Bride d'accouplement moteur - Flangia accoppiamento motore \_\_\_\_\_  
**/19** = Number of stages - Nombre d'étages- Numero degli stadi \_\_\_\_\_  
**A** = Impeller trimming - Rognage roue - Riduzione girante \_\_\_\_\_  
**-V** = Unit used at 50 Hz - Ensemble avec utilization a 50 Hz - Gruppo con impiego a 50 Hz \_\_\_\_\_

**E8R40N-8/11-W:**

**E** = Series - Série - Serie \_\_\_\_\_ **E 8 R 40 N - 8 /11 -W**  
**8** = DN in inch - DN en pouces - DN in pollici \_\_\_\_\_  
**R** = Radial impeller - Roue radiale - Girante radiale \_\_\_\_\_  
**40** = Hydraulic identification number - Numéro identifiant hydraulique - Numero identificativo idraulica \_\_\_\_\_  
**N** = NEMA coupling - Raccord aux normes NEMA - Attacco Nema \_\_\_\_\_  
**-8** = Coupling flange motor - Bride d'accouplement moteur - Flangia accoppiamento motore \_\_\_\_\_  
**/11** = Number of stages - Nombre d'étages- Numero degli stadi \_\_\_\_\_  
**-W** = Part with operation at 50Hz / 60Hz - Partie hydraulique avec emploi à 50Hz / 60Hz- Parte idraulica con impiego a 50Hz / 60Hz \_\_\_\_\_

**E10RB40N-8/14-V:**

**E** = Series - Série - Serie \_\_\_\_\_ **E 10 R B 40 N - 8 /14 -V:**  
**10** = DN in inch - DN en pouces - DN in pollici \_\_\_\_\_  
**R** = Radial impeller - Roue radiale - Girante radiale \_\_\_\_\_  
**B** = Intermediate casing construction - Version avec support intermediaire - Versione con supporto intermedio \_\_\_\_\_  
**40** = Hydraulic identification number - Numéro identifiant hydraulique - Numero identificativo idraulica \_\_\_\_\_  
**N** = NEMA coupling - Raccord aux normes NEMA - Attacco Nema \_\_\_\_\_  
**-8** = Coupling flange motor - Bride d'accouplement moteur - Flangia accoppiamento motore \_\_\_\_\_  
**/14** = Number of stages - Nombre d'étages- Numero degli stadi \_\_\_\_\_  
**-V** = Unit used at 50 Hz - Ensemble avec utilization a 50 Hz - Gruppo con impiego a 50 Hz \_\_\_\_\_

3) Examples of submersible motor identification codes - Identification du sigle des moteurs immergés - Esemplificazione sigle motori sommersi

**MAC625/3A-8 :**

**MAC=** Submersible motor - Moteur immergé - Motore sommerso \_\_\_\_\_ **MAC 6 25 /3A -8**  
**6** = Nominal diameter in inches - Diamètre nominal en pouces- Diametro nominale in pollici \_\_\_\_\_  
**25** = Nominal power in HP - Puissance nominale en HP - Potenza nominale in HP \_\_\_\_\_  
**/3** = Generational code - Code générationnel - Codice generazionale \_\_\_\_\_  
**A** = HI-TEC \_\_\_\_\_  
**-8** = Constructional features of electric motor \_\_\_\_\_  
*Caractéristiques de fabrication moteur électrique - Caratteristiche costruttive motore elettrico*

**MAC650/3B-8 :**

**MAC=** Submersible motor - Moteur immergé - Motore sommerso \_\_\_\_\_ **MAC 6 50 /3B -8**  
**6** = Nominal diameter in inches - Diamètre nominal en pouces- Diametro nominale in pollici \_\_\_\_\_  
**50** = Nominal power in HP - Puissance nominale en HP - Potenza nominale in HP \_\_\_\_\_  
**/3** = Generational code - Code générationnel - Codice generazionale \_\_\_\_\_  
**B** = HI-TEC Desert \_\_\_\_\_  
**-8** = Constructional features of electric motor \_\_\_\_\_  
*Caractéristiques de fabrication moteur électrique - Caratteristiche costruttive motore elettrico*

**MAC850-8 (MAC10/MAC12) :**

**MAC=** Submersible motor - Moteur immergé - Motore sommerso \_\_\_\_\_ **MAC 8 50 -8**  
**8** = Nominal diameter in inches - Diamètre nominal en pouces- Diametro nominale in pollici \_\_\_\_\_  
**50** = Nominal power in HP - Puissance nominale en HP - Potenza nominale in HP \_\_\_\_\_  
**-8** = Constructional features of electric motor \_\_\_\_\_  
*Caractéristiques de fabrication moteur électrique - Caratteristiche costruttive motore elettrico*

**M14300-8:**

**M** = Submersible motor - Moteur immergé - Motore sommerso \_\_\_\_\_ **M 14 300 -8**  
**14** = Nominal diameter in inches - Diamètre nominal en pouces- Diametro nominale in pollici \_\_\_\_\_  
**300** = Nominal power in HP - Puissance nominale en HP - Potenza nominale in HP \_\_\_\_\_  
**-8** = Constructional features of electric motor \_\_\_\_\_  
*Caractéristiques de fabrication moteur électrique - Caratteristiche costruttive motore elettrico*

**MAC10180/3A-8 :**

**MAC=** Submersible motor - Moteur immergé - Motore sommerso \_\_\_\_\_ **MAC 10 180 /3A -8**  
**10** = Nominal diameter in inches - Diamètre nominal en pouces- Diametro nominale in pollici \_\_\_\_\_  
**180** = Nominal power in HP - Puissance nominale en HP - Potenza nominale in HP \_\_\_\_\_  
**/3** = Generational code - Code générationnel - Codice generazionale \_\_\_\_\_  
**A** = HI-TEC \_\_\_\_\_  
**-8** = Constructional features of electric motor \_\_\_\_\_  
*Caractéristiques de fabrication moteur électrique - Caratteristiche costruttive motore elettrico*

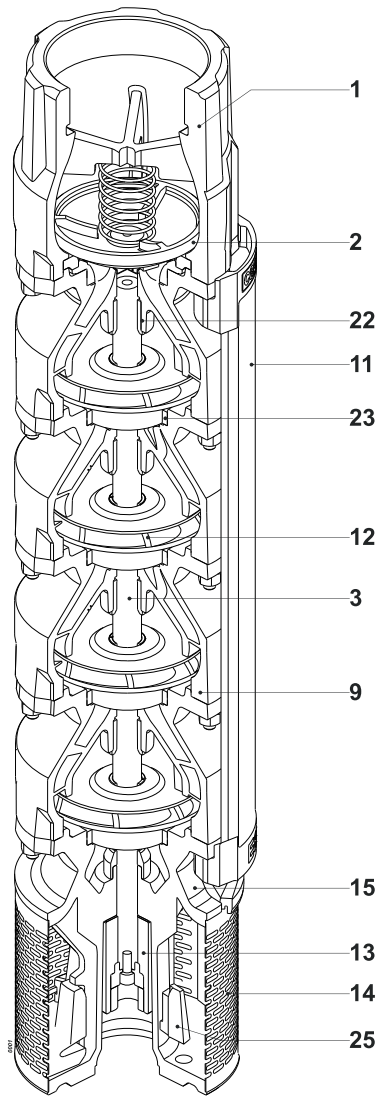

Pos.	Parts	Materials	Nomenclature	Matériaux	Nomenclatura	Materiale
1	Valve casing	Cast iron	Corps du clapet	Fonte grise	Corpo valvola	Ghisa grigia
2	Conical valve	Stainless steel	Clapet	Acier inox	Clapet	Acciaio inox
3	Pump shaft	Stainless steel	Arbre de pompe	Acier inox	Albero	Acciaio inox
9	Diffuser unit	Cast iron	Élément diffuseur	Fonte grise	Elemento diffusore	Ghisa grigia
11	Cable guard	Stainless steel	Gouttière de protection	Acier inox	Tegolo protezione cavi	Acciaio inox
12	Impeller	Cast iron	Roue	Fonte grise	Girante	Ghisa grigia
13	Coupling	Stainless steel	Accouplement rigide	Acier inox	Giunto rigido	Acciaio inox
14	Strainer	Stainless steel	Crépine	Acier inox	Succheruola	Acciaio inox
15	Suction casing	Cast iron	Pièce d'aspiration	Fonte grise	Supporto aspirazione	Ghisa grigia
22	Shaft bearing bush	Stainless steel/rubber	Coussinet arbre pompe	Acier inox/caoutchouc	Cuscinetto albero	Acciaio inox/gomma
23	Wear ring	Steel/Rubber	Bague d'usure	Acier/Caoutchouc	Anello sede girante	Acciaio/Gomma
25	Defender®	.	Defender®	.	Defender®	.

Bolts and nuts in stainless steel.

Visserie en acier inox

Bulloneria in acciaio inox

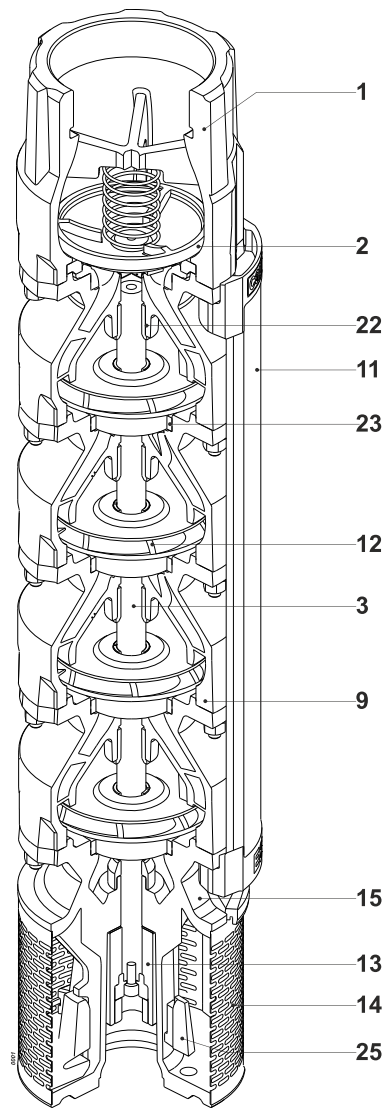

Pos.	Parts	Materials	Nomenclature	Matériaux	Nomenclatura	Materiale
1	Valve casing	Cast iron	Corps du clapet	Fonte grise	Corpo valvola	Ghisa grigia
2	Conical valve	Stainless steel	Clapet	Acier inox	Clapet	Acciaio inox
3	Pump shaft	Stainless steel	Arbre de pompe	Acier inox	Albero	Acciaio inox
9	Diffuser unit	Cast iron	Élément diffuseur	Fonte grise	Elemento diffusore	Ghisa grigia
11	Cable guard	Stainless steel	Gouttière de protection	Acier inox	Tegolo protezione cavi	Acciaio inox
12	Impeller	Cast iron	Roue	Fonte grise	Girante	Ghisa grigia
13	Coupling	Stainless steel	Accouplement rigide	Acier inox	Giunto rigido	Acciaio inox
14	Strainer	Stainless steel	Crépine	Acier inox	Succheruola	Acciaio inox
15	Suction casing	Cast iron	Pièce d'aspiration	Fonte grise	Supporto aspirazione	Ghisa grigia
22	Shaft bearing bush	Stainless steel/rubber	Coussinet arbre pompe	Acier inox/caoutchouc	Cuscinetto albero	Acciaio inox/gomma
23	Wear ring	Steel/Rubber	Bague d'usure	Acier inox/caoutchouc	Anello sede girante	Acciaio inox/gomma
25	Defender®	Steel/Rubber	Defender®		Defender®	

Bolts and nuts in stainless steel

Visserie en acier inox

Bulloneria in acciaio inox

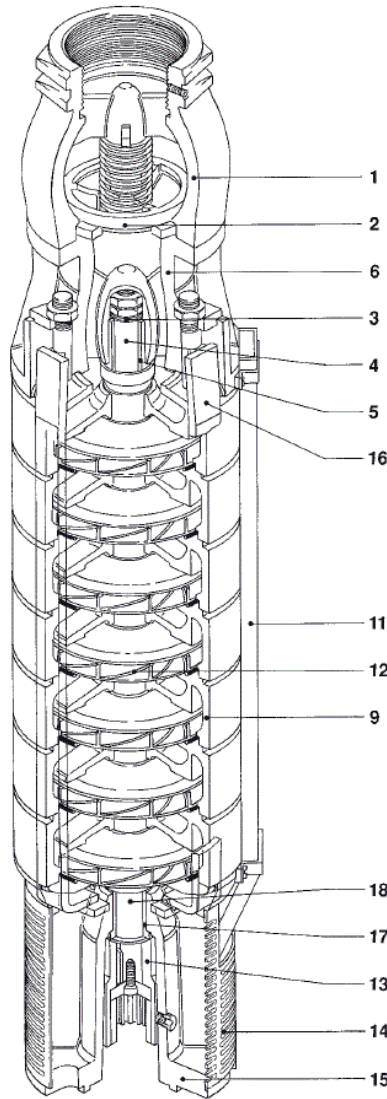

Pos.	Parts	Materials	Nomenclature	Matériaux	Nomenclatura	Materiale
1	Valve casing	Cast iron	Corps du clapet	Fonte grise	Corpo valvola	Ghisa grigia
2	Conical valve	Cast iron	Clapet	Fonte grise	Clapet	Ghisa grigia
3	Pump shaft	Stainless steel	Arbre de pompe	Acier inox	Albero	Acciaio inox
4 (18)	Shaft sleeve	Stainless steel	Entretoise d'arbre	Acier inox	Bussola albero	Acciaio inox
5 (17)	Bearing bush	Bronze	coussinet	Bronze	Bronzina	Bronzo
6	Delivery casing	Cast iron	Corps de refoulement	Fonte grise	Corpo mandata	Ghisa grigia
9	Diffuser unit	Cast iron	Élément diffuseur	Fonte grise	Elemento diffusore	Ghisa grigia
11	Cable guard	Stainless steel	Gouttière de protection	Acier inox	Tegolo protezione cavi	Acciaio inox
12	Impeller (E8R)	Technopolymer	Roue (E8R)	Polymère technique	Girante (E8R)	Tecnopolimero
12	Impeller (E10R)	Cast iron	Roue (E10R)	Fonte grise	Girante (E10R)	Ghisa grigia
13	Coupling	Stainless steel	Accouplement rigide	Acier inox	Giunto rigido	Acciaio inox
14	Strainer	Stainless steel	Crépine	Acier inox	Succheruola	Acciaio inox
15	Suction casing (E8R)	Cast iron	Pièce d'aspiration (E8R)	Fonte grise	Supporto aspirazione (E8R)	Ghisa grigia
15	Suction casing (E10R)	Nodular cast iron	Pièce d'aspiration (E10R)	Fonte sphéroidale	Supporto aspirazione (E10R)	Ghisa sferoidale
16	Tie rod	Steel	Tirant	Acier	Tirante	Acciaio

Bolts and nuts in stainless steel.

Visserie en acier inox

Bulloneria in acciaio inox

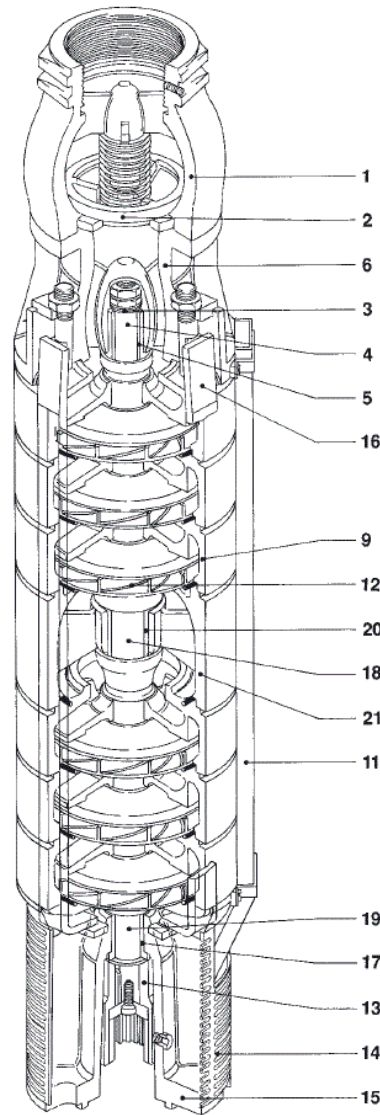

Pos.	Parts	Materials	Nomenclature	Matériaux	Nomenclatura	Materiale
1	Valve casing	Cast iron	Corps du clapet	Fonte grise	Corpo valvola	Ghisa grigia
2	Conical valve	Cast iron	Clapet	Fonte grise	Clapet	Ghisa grigia
3	Pump shaft	Stainless steel	Arbre de pompe	Acier inox	Albero	Acciaio inox
4 (18) (19)	Shaft sleeve	Stainless steel	Entretoise d'arbre	Acier inox	Bussola albero	Acciaio inox
5 (17) (20)	Bearing bush	Bronze	coussinet	Bronze	Bronzina	Bronzo
6	Delivery casing	Cast iron	Corps de refoulement	Fonte grise	Corpo mandata	Ghisa grigia
9	Diffuser unit	Cast iron	Élément diffuseur	Fonte grise	Elemento diffusore	Ghisa grigia
11	Cable guard	Stainless steel	Gouttière de protection	Acier inox	Tegolo protezione cavi	Acciaio inox
12	Impeller (E8RB)	Technopolymer	Roue (E8RB)	Polymère technique	Girante (E8RB)	Tecnopolimero
12	Impeller (E10RB)	Cast iron	Roue (E10RB)	Fonte grise	Girante (E10RB)	Ghisa grigia
13	Coupling	Stainless steel	Accouplement rigide	Acier inox	Giunto rigido	Acciaio inox
14	Strainer	Stainless steel	Crépine	Acier inox	Succheruola	Acciaio inox
15	Suction casing	Nodular cast iron	Pièce d'aspiration	Fonte sphéroidale	Supporto aspirazione	Ghisa sferoidale
16	Tie rod	Steel	Tirant	Acier	Tirante	Acciaio
21	Intermediate bearing	Cast iron	Palier intermediaire	Fonte grise	Supporto intermedio	Ghisa grigia

Bolts and nuts in stainless steel.

Visserie en acier inox

Bulloneria in acciaio inox

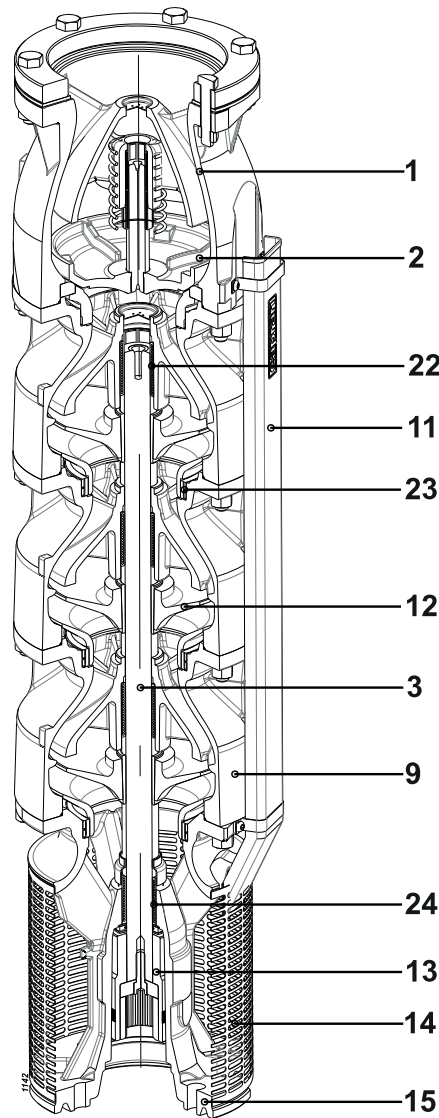

Pos.	Parts	Materials	Nomenclature	Matériaux	Nomenclatura	Materiale
1	Valve casing	Cast iron	<i>Corps du clapet</i>	<i>Fonte grise</i>	<b>Corpo valvola</b>	<b>Ghisa grigia</b>
2	Conical valve	Cast iron	<i>Clapet</i>	<i>Fonte grise</i>	<b>Clapet</b>	<b>Ghisa grigia</b>
3	Pump shaft	Stainless steel	<i>Arbre de pompe</i>	<i>Acier inox</i>	<b>Albero</b>	<b>Acciaio inox</b>
9	Diffuser unit	Cast iron	<i>Élément diffuseur</i>	<i>Fonte grise</i>	<b>Elemento diffusore</b>	<b>Ghisa grigia</b>
11	Cable guard	Stainless steel	<i>Gouttière de protection</i>	<i>Acier inox</i>	<b>Tegolo protezione cavi</b>	<b>Acciaio inox</b>
12	Impeller	Cast iron	<i>Roue</i>	<i>Fonte grise</i>	<b>Girante</b>	<b>Ghisa grigia</b>
13	Coupling	Stainless steel	<i>Accouplement rigide</i>	<i>Acier inox</i>	<b>Giunto rigido</b>	<b>Acciaio inox</b>
14	Strainer	Stainless steel	<i>Crépine</i>	<i>Acier inox</i>	<b>Succheruola</b>	<b>Acciaio inox</b>
15	Suction casing	Nodular cast iron	<i>Pièce d'aspiration</i>	<i>Fonte sphéroïdale</i>	<b>Supporto aspirazione</b>	<b>Ghisa sferoidale</b>
22 (24)	Shaft bearing bush	Stainless steel/rubber	<i>Coussinet arbre pompe</i>	<i>Acier inox/caoutchouc</i>	<b>Cuscinetto albero</b>	<b>Acciaio inox/gomma</b>
23	Wear ring	Steel/Rubber	<i>Bague d'usure</i>	<i>Acier/Caoutchouc</i>	<b>Anello sede girante</b>	<b>Acciaio/Gomma</b>

Bolts and nuts in stainless steel

*Visserie en acier inox*

Bulloneria in acciaio inox



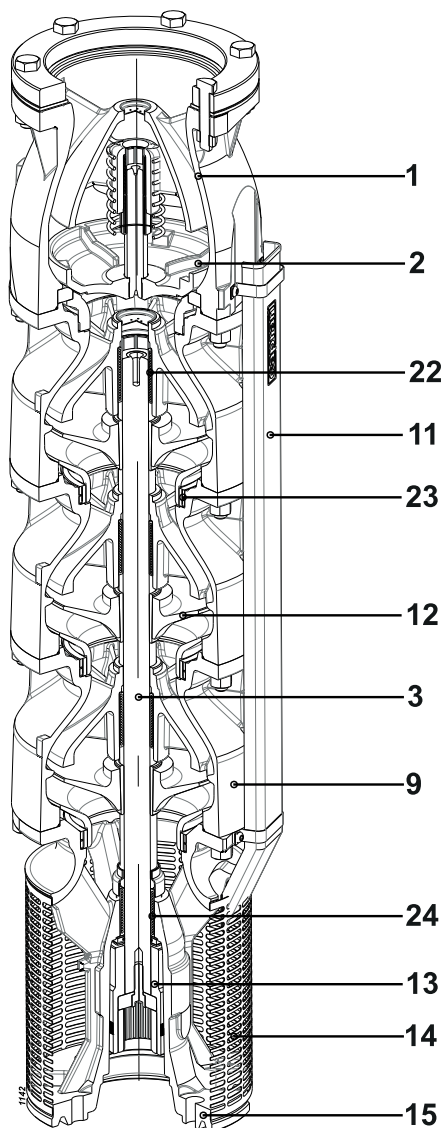

Pos.	Parts	Materials	Nomenclature	Matériaux	Nomenclatura	Materiale
1	Valve casing	Cast iron	Corps du clapet	Fonte grise	Corpo valvola	Ghisa grigia
2	Conical valve	Cast iron	Clapet	Fonte grise	Clapet	Ghisa grigia
3	Pump shaft	Stainless steel	Arbre de pompe	Acier inox	Albero	Acciaio inox
9	Diffuser unit	Cast iron	Élément diffuseur	Fonte grise	Elemento diffusore	Ghisa grigia
11	Cable guard	Stainless steel	Gouttière de protection	Acier inox	Tegolo protezione cavi	Acciaio inox
12	Impeller	Cast iron	Roue	Fonte grise	Girante	Ghisa grigia
13	Coupling	Stainless steel	Accouplement rigide	Acier inox	Giunto rigido	Acciaio inox
14	Strainer	Stainless steel	Crépine	Acier inox	Succheruola	Acciaio inox
15	Suction casing	Nodular cast iron	Pièce d'aspiration	Fonte sphéroïdale	Supporto aspirazione	Ghisa sferoidale
22 (24)	Shaft bearing bush	Stainless steel/rubber	Coussinet arbre pompe	Acier inox/caoutchouc	Cuscinetto albero	Acciaio inox/gomma
23	Wear ring	Stainless steel/rubber	Bague d'usure	Acier inox/caoutchouc	Anello sede girante	Acciaio inox/gomma
23	Wear ring (E12S58)	Steel	Bague d'usure (E12S58)	Acier	Anello sede girante (E12S58)	Acciaio

Bolts and nuts in stainless steel

Visserie en acier inox

Bulloneria in acciaio inox

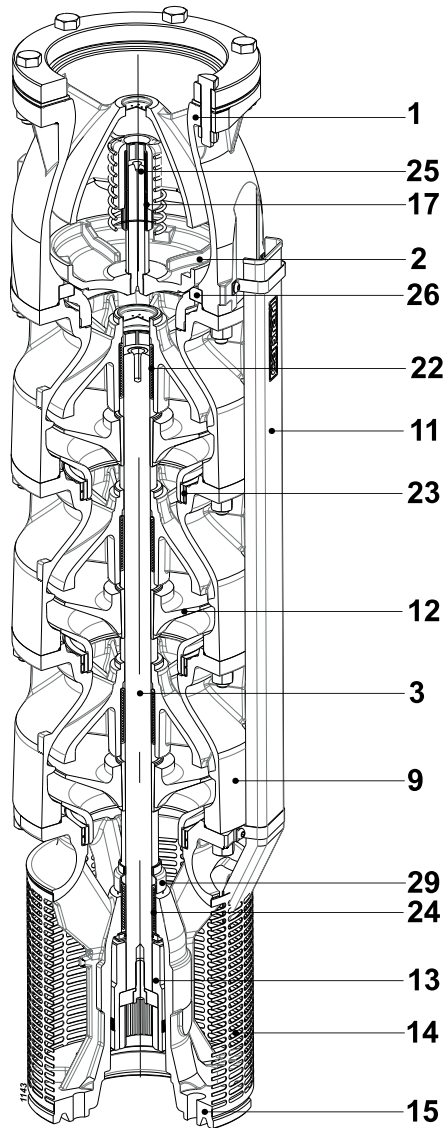

Pos.	Parts	Materials	Nomenclature	Matériaux	Nomenclatura	Materiale
1	Valve casing	Nodular cast iron	Corps du clapet	Fonte sphéroïdale	Corpo valvola	Ghisa sferoidale
2	Conical valve	Cast iron/rubber	Clapet	Fonte grise/caoutchouc	Clapet	Ghisa grigia/gomma
3	Pump shaft	Stainless steel	Arbre de pompe	Acier inox	Albero	Acciaio inox
9	Diffuser unit	Cast iron	Élément diffuseur	Fonte grise	Elemento diffusore	Ghisa grigia
11	Cable guard	Stainless steel	Gouttière de protection	Acier inox	Tegolo protezione cavi	Acciaio inox
12	Impeller	Stainless steel	Roue	Acier inox	Girante	Acciaio inox
13	Coupling	Stainless steel	Accouplement rigide	Acier inox	Giunto rigido	Acciaio inox
14	Strainer	Stainless steel	Crépine	Acier inox	Succheruola	Acciaio inox
15	Suction casing	Nodular cast iron	Pièce d'aspiration	Fonte sphéroïdale	Supporto aspirazione	Ghisa sferoidale
17	Bearing bush	Stainless steel/rubber	Coussinet	Acier inox/caoutchouc	Cuscinetto albero valvola	Acciaio inox/gomma
22 (24)	Pump shaft bearing bush	Stainless steel/rubber	Coussinet arbre	Acier inox/caoutchouc	Cuscinetto albero	Acciaio inox/gomma
23	Wear ring	Cast iron	Bague d'usure	Fonte grise	Anello sede girante	Ghisa grigia
25	Valve spindle	Stainless steel	Tige de soupape	Acier inox	Albero valvola	Acciaio inox
26	Valve ring	Bronze	Bague du clapet	Bronze	Anello valvola	Bronzo
29	Sand guard	Stainless steel/rubber	Para-sable	Acier inox/caoutchouc	Parasabbia	Acciaio inox/gomma

Bolts and nuts in stainless steel

Visserie en acier inox

Bulloneria in acciaio inox

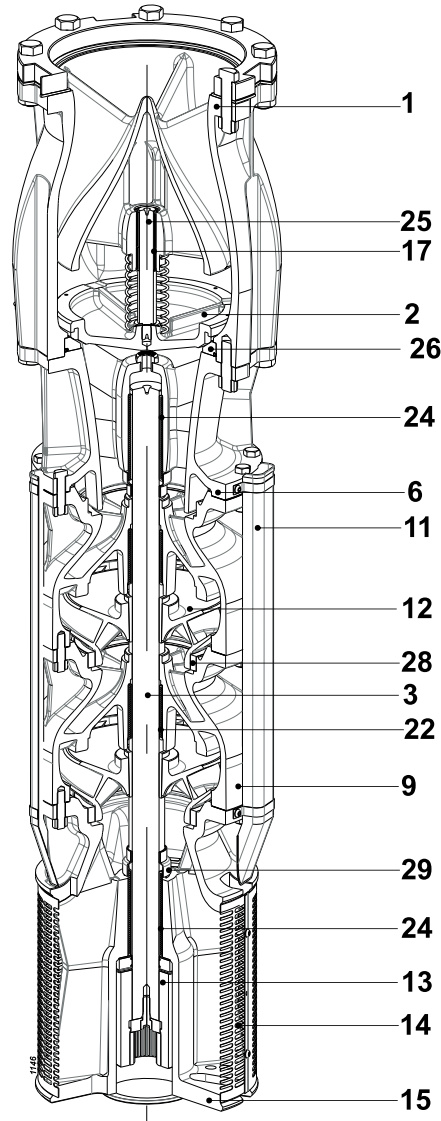

Pos.	Parts	Materials	Nomenclature	Matériaux	Nomenclatura	Materiale
1	Valve casing	Cast iron	Corps du clapet	Fonte grise	Corpo valvola	Ghisa grigia
2	Conical valve	Cast iron/rubber	Clapet	Fonte grise/ Gomma	Clapet	Ghisa grigia/gomma
3	Pump shaft	Stainless steel	Arbre de pompe	Acier inox	Albero	Acciaio inox
6	Delivery casing (E14S50)	Cast iron	Corps de refoulement (E14S50)	Fonte grise	Corpo mandata (E14S50)	Ghisa grigia
6	Delivery casing (E14S55)	Nodular cast iron	Corps de refoulement (E14S55)	Fonte sphéroidale	Corpo mandata (E14S55)	Ghisa sferoidale
9	Diffuser unit	Cast iron	Élément diffuseur	Fonte grise	Elemento diffusore	Ghisa grigia
11	Cable guard	Stainless steel	Gouttière de protection	Acier inox	Tegolo protezione cavi	Acciaio inox
12	Impeller	Stainless steel	Roue	Acier inox	Girante	Acciaio inox
13	Coupling	Stainless steel	Accouplement rigide	Acier inox	Giunto rigido	Acciaio inox
14	Strainer	Stainless steel	Crépine	Acier inox	Succheruola	Acciaio inox
15	Suction casing	Nodular cast iron	Pièce d'aspiration	Fonte sphéroidale	Supporto aspirazione	Ghisa sferoidale
17	Bearing bush	Stainless steel/rubber	Coussinet	Acier inox/caoutchouc	Cuscinetto albero valvola	Acciaio inox/gomma
22 (24)	Pump shaft bearing bush	Stainless steel/rubber	Coussinet arbre	Acier inox/caoutchouc	Cuscinetto albero	Acciaio inox/gomma
25	Valve spindle	Stainless steel	Tige de soupape	Acier inox	Albero valvola	Acciaio inox
26	Valve ring	Bronze	Bague du clapet	Bronze	Anello valvola	Bronzo
28	Wear ring	Cast iron	Bague d'usure	Fonte grise	Anello sede girante	Ghisa grigia
29	Sand guard	Stainless steel/rubber	Para-sable	Acier inox/caoutchouc	Parasabbia	Acciaio inox/gomma

Bolts and nuts in stainless steel

Visserie en acier inox

Bulloneria in acciaio inox

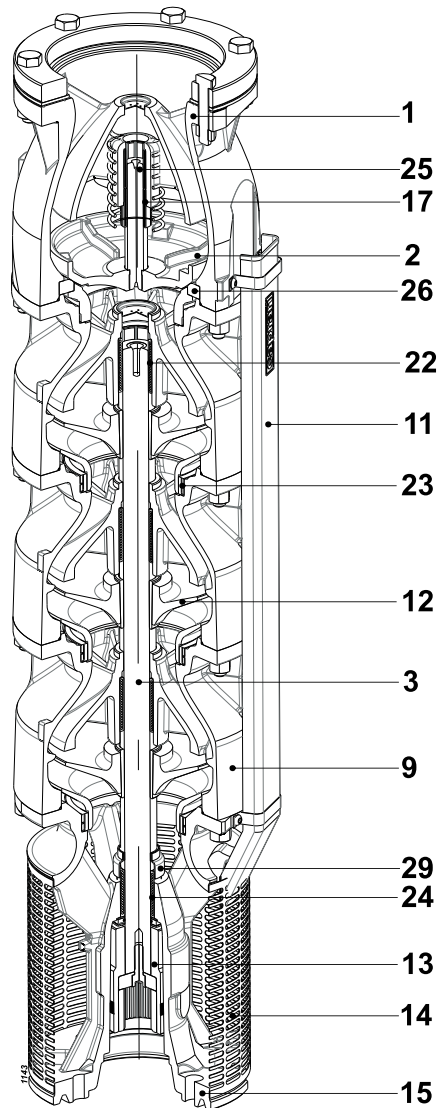

Pos.	Parts	Materials	Nomenclature	Matériaux	Nomenclatura	Materiale
1	Valve casing	Nodular cast iron	Corps du clapet	Fonte sphéroïdale	Corpo valvola	Ghisa sferoidale
2	Conical valve	Cast iron/rubber	Clapet	Fonte grise/caoutchouc	Clapet	Ghisa grigia/gomma
3	Shaft	Stainless steel	Arbre	Acier inox	Albero	Acciaio inox
6	Delivery casing	Cast iron	Corps de refoulement	Fonte grise	Corpo mandata	Ghisa grigia
6	Delivery casing (E14SE55)	Nodular cast iron	Corps de refoulement (E14SE55)	Fonte sphéroïdale	Corpo mandata (E14SE55)	Ghisa sferoidale
9	Diffuser unit	Cast iron	Élément diffuseur	Fonte grise	Elemento diffusore	Ghisa grigia
11	Cable guard	Stainless steel	Gouttière de protection	Acier inox	Tegolo protezione cavi	Acciaio inox
12	Impeller	Stainless steel	Roue	Acier inox	Girante	Acciaio inox
13	Coupling	Stainless steel	Accouplement rigide	Acier inox	Giunto rigido	Acciaio inox
14	Strainer	Stainless steel	Crépine	Acier inox	Succheruola	Acciaio inox
15	Suction casing	Nodular cast iron	Pièce d'aspiration	Fonte sphéroïdale	Supporto aspirazione	Ghisa sferoidale
17	Bearing bush	Stainless steel/rubber	Coussinet	Acier inox/caoutchouc	Cuscinetto albero valvola	Acciaio inox/gomma
22 (24)	Pump shaft bearing bush	Stainless steel/rubber	Coussinet arbre pompe	Acier inox/caoutchouc	Cuscinetto albero	Acciaio inox/gomma
25	Valve spindle	Stainless steel	Tige de soupape	Acier inox	Albero valvola	Acciaio inox
26	Valve ring	Bronze	Bague du clapet	Bronze	Anello valvola	Bronzo
28	Wear ring	Cast iron	Bague d'usure	Fonte grise	Anello sede girante	Ghisa grigia
29	Sand guard	Stainless steel/rubber	Para-sable	Acier inox/caoutchouc	Parasabbia	Acciaio inox/gomma

Bolts and nuts in stainless steel

Visserie en acier inox

Bulloneria in acciaio inox

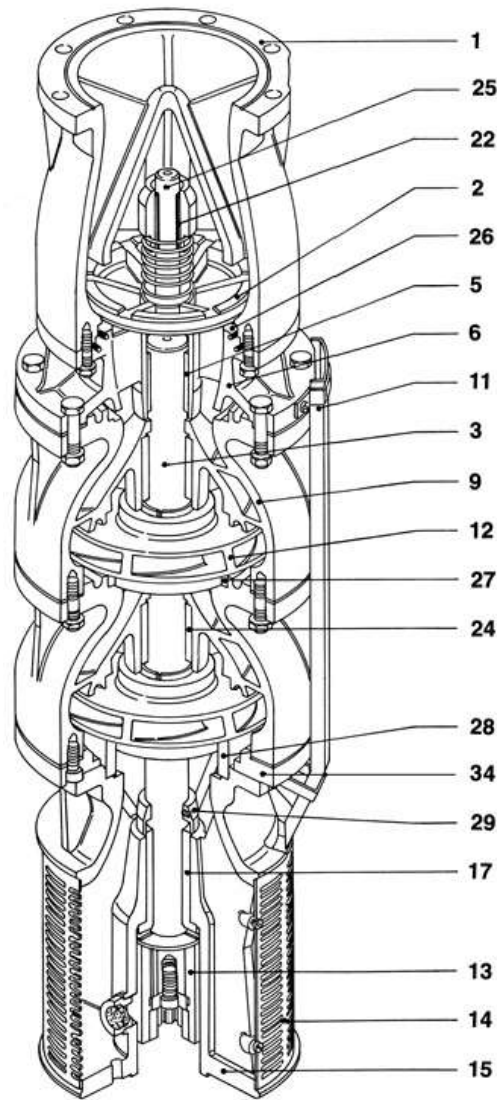

Pos.	Parts	Materials	Nomenclature	Matériaux	Nomenclatura	Materiale
1	Valve casing	Nodular cast iron	Corps du clapet	Fonte sphéroïdale	Corpo valvola	Ghisa sferoidale
2	Conical valve	Cast iron/rubber	Clapet	Fonte grise/caoutchouc	Clapet	Ghisa grigia/gomma
3	Pump shaft	Stainless steel	Arbre de pompe	Acier inox	Albero	Acciaio inox
5 (17)	Bearing bush	Bronze	coussinet	Bronze	Bronzina	Bronzo
6	Delivery casing	Cast iron	Corps de refoulement	Fonte grise	Corpo mandata	Ghisa grigia
9	Diffuser unit	Cast iron	Élément diffuseur	Fonte grise	Elemento diffusore	Ghisa grigia
11	Cable guard	Stainless steel	Gouttière de protection	Acier inox	Tegolo protezione cavi	Acciaio inox
12	Impeller	Stainless steel	Roue	Acier inox	Girante	Acciaio inox
13	Coupling	Stainless steel	Accouplement rigide	Acier inox	Giunto rigido	Acciaio inox
14	Strainer	Stainless steel	Crépine	Acier inox	Succheruola	Acciaio inox
15	Suction casing	Nodular cast iron	Pièce d'aspiration	Fonte sphéroïdale	Supporto aspirazione	Ghisa sferoidale
22	Bearing bush		Coussinet		Cuscinetto asta di trasmissione	
24	Pump shaft bearing bush	Bronze	Coussinet arbre pompe	Bronze	Cuscinetto albero	Bronzo
25	Valve spindle	Stainless steel	Tige de soupape	Acier inox	Albero valvola	Acciaio inox
26	Valve ring	Cast iron	Bague du clapet	Fonte grise	Anello valvola	Ghisa grigia
27 (28)	Wear ring	Cast iron	Bague d'usure	Fonte grise	Anello sede girante	Ghisa grigia
29	Sand guard	Stainless steel/rubber	Para-sable	Acier inox/caoutchouc	Parasabbia	Acciaio inox/gomma
34	Connecting flange	Steel	Bride de connexion	Acier	Elemento di raccordo	Acciaio

Bolts and nuts in stainless steel

Visserie en acier inox

Bulloneria in acciaio inox

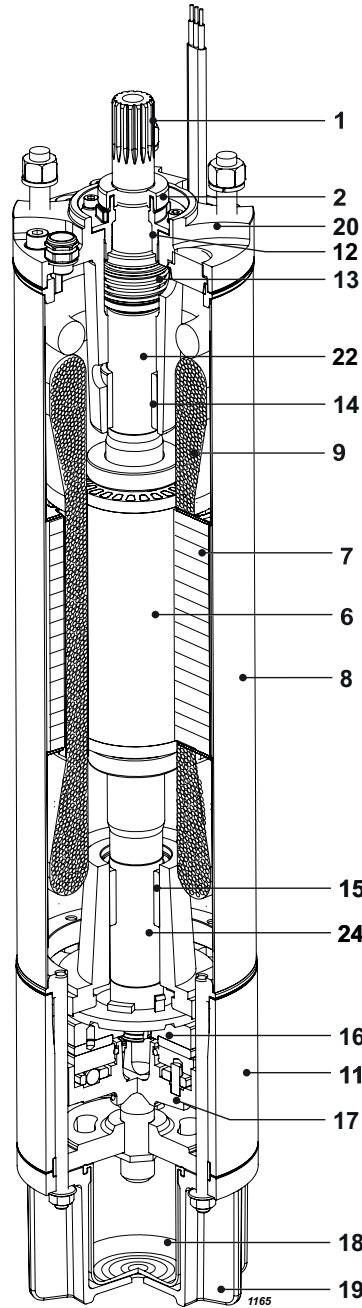

Pos.	Parts	Materials	Nomenclature	Matériaux	Nomenclatura	Materiale
1	Shaft	Stainless steel	Arbre	Acier inox	Albero	Acciaio inox
2	Sand guard	Rubber	para-sable	Caoutchouc	Parasabbia	Gomma
6	Rotor	Electrical steel	Rotor	Tôle magnétique	Rotore	Lamierino magnetico
7	Stator	Electrical steel	Stator	Tôle magnétique	Statore	Lamierino magnetico
8	Stator shell	Stainless steel	Chemise de stator	Acier inox	Camicia statore	Acciaio inox
9	Winding	PPC	Bobinage	PPC	Avvolgimento	PPC
11	Lower bracket	Cast iron	Support inférieur	Fonte grise	Supporto inferiore	Ghisa grigia
12	Mechanical seal cover	Technopolymer	Couvercle garniture mécanique	Polymère technique	Coperchio tenuta meccanica	Tecnopolimero
13	Mechanical seal	Silicon carbide/silicon carbide	Garniture mécanique	Carbure de silicium/ carbure de silicium	Tenuta meccanica	Carburo di silicio/ carburo di silicio
14 (15)	Bearing	Graphite	Roulement	Graphite	Cuscinetto	Grafite
16	Thrust-bearing	Stainless steel/ Synthetic compound	Butée	Acier inox/Composé synthétique	Reggispinta	Acciaio inox/ Composito sintetico
17	Thrust-bearing foot slip	Cast iron	Support butée	Fonte grise	Supporto reggispinta	Ghisa grigia
18	Diaphragm	Rubber	Membrane	Caoutchouc	Membrana	Gomma
19	Diaphragm cover	Cast iron	Couvercle de membrane	Fonte grise	Coperchio membrana	Ghisa grigia
20	Upper bracket	Cast iron	Support supérieur	Fonte grise	Supporto superiore	Ghisa grigia
22 (24)	Shaft sleeve	Steel	Chemise d'arbre	Acier	Bussola	Acciaio

Bolts and nuts in stainless steel.

Visserie en acier inox

Bulloneria in acciaio inox

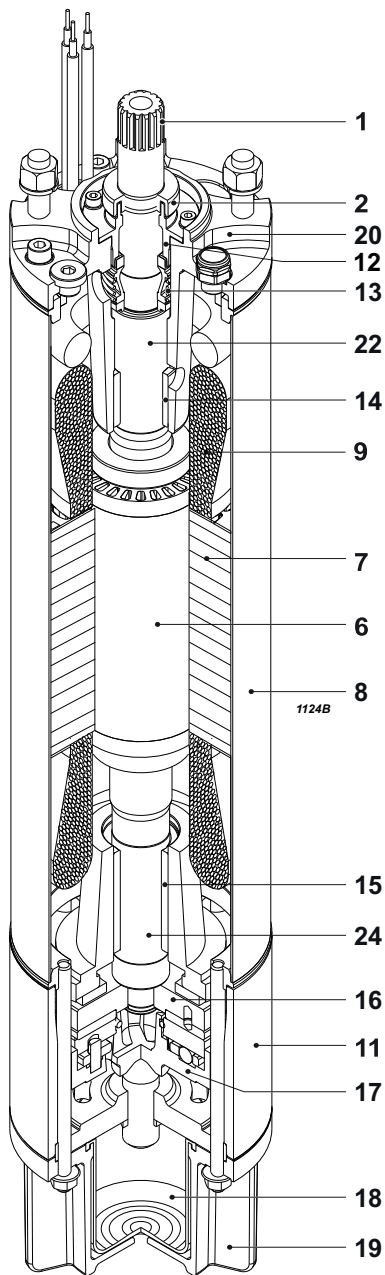

Pos.	Parts	Materials	Nomenclature	Matériaux	Nomenclatura	Materiale
1	Shaft	Stainless steel	Arbre	Acier inox	Albero	Acciaio inox
2	Sand guard	Rubber	Para-sable	Caoutchouc	Parasabbia	Gomma
6	Rotor	Electrical steel	Rotor	Tôle magnétique	Rotore	Lamierino magnetico
7	Stator	Electrical steel	Stator	Tôle magnétique	Statore	Lamierino magnetico
8	Stator shell	Stainless steel	Chemise de stator	Acier inox	Camicia statore	Acciaio inox
9	Winding	PPC	Bobinage	PPC	Avvolgimento	PPC
11	Lower bracket	Cast iron	Support inférieur	Fonte grise	Supporto inferiore	Ghisa grigia
12	Mechanical seal cover	Stainless steel	mécanique d'étanchéité	Acier inox	Coperchio tenuta meccanica	Acciaio inox
13	Mechanical seal	Silicon carbide/silicon carbide	Garniture mécanique	Carbure de silicium/ carbure de silicium	Tenuta meccanica	Carburo di silicio/ carburo di silicio
14 (15)	Bearing	Graphite	Roulement	Graphite	Cuscinetto	Grafite
16	Thrust-bearing	Stainless steel/ Synthetic compound	Butée	Acier inox/Composé synthétique	Reggispinta	Acciaio inox/ Composito sintetico
17	Thrust-bearing foot slip	Cast iron	Support butée	Fonte grise	Supporto reggispinta	Ghisa grigia
18	Diaphragm	Rubber	Membrane	Caoutchouc	Membrana	Gomma
19	Diaphragm cover	Cast iron	Couvercle de membrane	Fonte grise	Coperchio membrana	Ghisa grigia
20	Upper bracket	Cast iron	Support supérieur	Fonte grise	Supporto superiore	Ghisa grigia
22 (24)	Shaft sleeve	Steel	Chemise d'arbre	Acier	Bussola	Acciaio

Bolts and nuts in stainless steel.

Visserie en acier inox

Bulloneria in acciaio inox

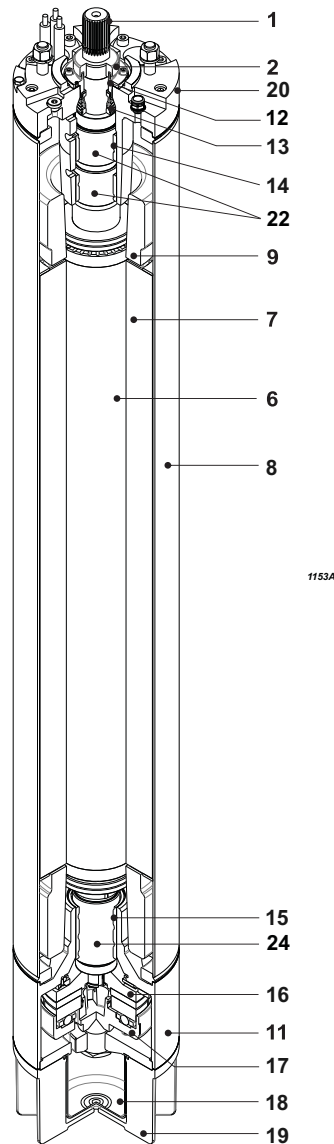

1153A

Pos.	Parts	Materials	Nomenclature	Matériaux	Nomenclatura	Materiale
1	Shaft	Stainless steel	Arbre	Acier inox	Albero	Acciaio inox
2	Sand guard	Rubber	para-sable	Caoutchouc	Parasabbia	Gomma
6	Rotor	Electrical steel	Rotor	Tôle magnétique	Rotore	Lamierino magnetico
7	Stator	Electrical steel	Stator	Tôle magnétique	Statore	Lamierino magnetico
8	Stator shell	Stainless steel	Chemise de stator	Acier inox	Camicia statore	Acciaio inox
9	Winding	PPC	Bobinage	PPC	Avvolgimento	PPC
11	Lower bracket	Cast iron	Support inférieur	Fonte grise	Supporto inferiore	Ghisa grigia
12	Cover mechanical seal	Stainless steel	Couvercle garniture mécanique	Acier inox	Coperchio tenuta meccanica	Acciaio inox
13	Mechanical seal	Silicon carbide/silicon carbide	Garniture mécanique	Carbure de silicium/ carbure de silicium	Tenuta meccanica	Carburo di silicio/ carburo di silicio
14 (15)	Bearing	Graphite	Roulement	Graphite	Cuscinetto	Grafite
16	Thrust-bearing	Stainless steel/ Synthetic compound	Butée	Acier inox/Composé synthétique	Reggispinta	Acciaio inox/ Composito sintetico
17	Thrust-bearing foot slip	Cast iron	Support butée	Fonte grise	Supporto reggispinta	Ghisa grigia
18	Diaphragm	Rubber	Membrane	Caoutchouc	Membrana	Gomma
19	Diaphragm cover	Cast iron	Couvercle de membrane	Fonte grise	Coperchio membrana	Ghisa grigia
20	Upper bracket	Cast iron	Support supérieur	Fonte grise	Supporto superiore	Ghisa grigia
22 (24)	Shaft sleeve	Steel	Chemise arbre	Acier	Bussola	Acciaio

Bolts and nuts in stainless steel.  
Cables outlet: see "Cables outlet"

Visserie en acier inox  
Sortie câbles voir "Sortie câbles"

Bulloneria in acciaio inox  
Uscita cavi: vedere "uscita cavi"



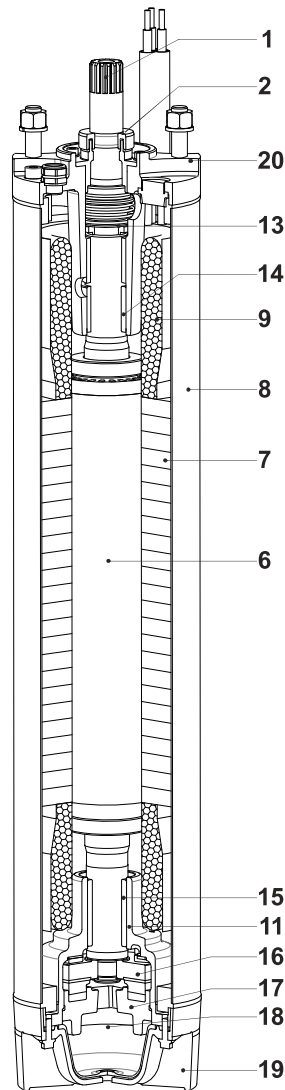

						
Pos.	Parts	Materials	Nomenclature	Matériaux	Nomenclatura	Materiale
1	Shaft	Stainless steel	Arbre	Acier inox	Albero	Acciaio inox
2	Sand guard	Rubber	para-sable	Caoutchouc	Parasabbia	Gomma
6	Rotor	Electrical steel	Rotor	Tôle magnétique	Rotore	Lamierino magnetico
7	Stator	Electrical steel	Stator	Tôle magnétique	Statore	Lamierino magnetico
8	Stator shell	Stainless steel	Chemise de stator	Acier inox	Camicia statore	Acciaio inox
9	Winding	Green wire/PPC	Bobinage	Green wire/PPC	Avvolgimento	Green wire/PPC
11	Lower bracket	Cast iron	Support inférieur	Fonte grise	Supporto inferiore	Ghisa grigia
13	Mechanical seal	Silicon carbide/silicon carbide	Garniture mécanique	Carbure de silicium/ carbure de silicium	Tenuta meccanica	Carburo di silicio/ carburo di silicio
14 (15)	Bearing	HT Synthetic	Coussinet	Composé HT	Cuscinetto	Composito HT
16	Thrust-bearing	HT	Butée	HT	Reggispinta	HT
17	Thrust-bearing foot slip	Cast iron	Support butée	Fonte grise	Supporto reggispinta	Ghisa grigia
18	Diaphragm	Rubber	Membrane	Caoutchouc	Membrana	Gomma
19	Diaphragm cover	Technopolymer	Couvercle de membrane	Polymère technique	Coperchio membrana	Tecnopolimero
20	Upper bracket	Cast iron	Support supérieur	Fonte grise	Supporto superiore	Ghisa grigia

Bolts and nuts in stainless steel.

Visserie en acier inox

Bulloneria in acciaio inox

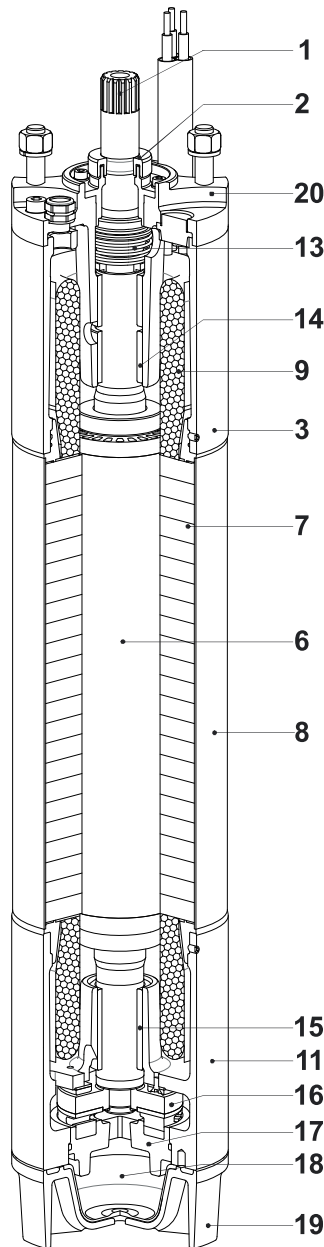

Pos.	Parts	Materials	Nomenclature	Matériaux	Nomenclatura	Materiale
1	Shaft	Stainless steel	Arbre	Acier inox	Albero	Acciaio inox
2	Sand guard	Rubber	para-sable	Caoutchouc	Parasabbia	Gomma
3	Upper cover	Cast iron	Couvercle supérieur	Fonte grise	Coperchio superiore	Ghisa grigia
6	Rotor	Electrical steel	Rotor	Tôle magnétique	Rotore	Lamierino magnetico
7	Stator	Electrical steel	Stator	Tôle magnétique	Statore	Lamierino magnetico
8	Stator shell	Stainless steel	Chemise de stator	Acier inox	Camicia statore	Acciaio inox
9	Winding	Green wire	Bobinage	Green wire	Avvolgimento	Green wire
11	Lower bracket	Cast iron	Support inférieur	Fonte grise	Supporto inferiore	Ghisa grigia
13	Mechanical seal	Silicon carbide/silicon carbide	Garniture mécanique	Carbure de silicium/ carbure de silicium	Tenuta meccanica	Carburo di silicio/ carburo di silicio
14 (15)	Bearing	HT Synthetic	Coussinet	Composé HT	Cuscinetto	Composito HT
16	Thrust-bearing	HT	Butée	HT	Reggispinta	HT
17	Thrust-bearing foot slip	Cast iron	Support butée	Fonte grise	Supporto reggispinta	Ghisa grigia
18	Diaphragm	Rubber	Membrane	Caoutchouc	Membrana	Gomma
19	Diaphragm cover	Cast iron	Couvercle de membrane	Fonte grise	Coperchio membrana	Ghisa grigia
20	Upper bracket	Cast iron	Support supérieur	Fonte grise	Supporto superiore	Ghisa grigia

Bolts and nuts in stainless steel.

Visserie en acier inox

Bulloneria in acciaio inox

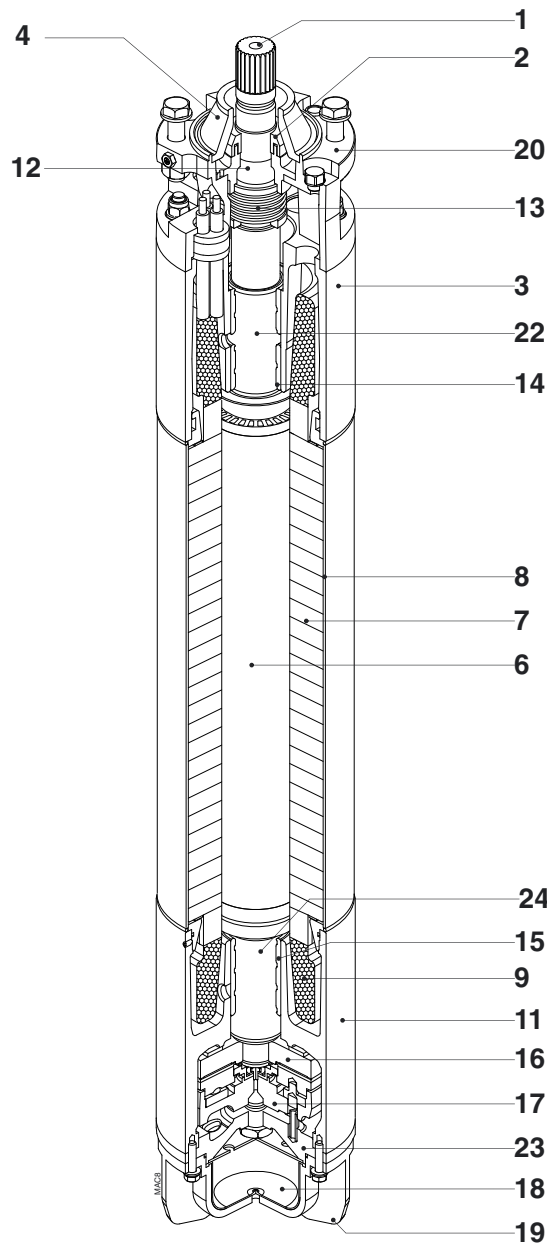

Pos.	Parts	Materials	Nomenclature	Matériaux	Nomenclatura	Materiale
1	Shaft	Stainless steel	Arbre	Acier inox	Albero	Acciaio inox
2	Sand guard	Rubber	Para-sable	Caoutchouc	Parasabbia	Gomma
3	Upper bracket	Cast iron	Support supérieur	Fonte grise	Supporto superiore	Ghisa grigia
4*	Protection	Rubber	Protecteur	Caoutchouc	Protettore	Gomma
6	Rotor	Electrical steel	Rotor	Tôle magnétique	Rotore	Lamierino magnetico
7	Stator	Electrical steel	Stator	Tôle magnétique	Statore	Lamierino magnetico
8	Stator shell	Stainless steel	Chemise de stator	Acier inox	Camicia statore	Acciaio inox
9	Winding	Green wire	Bobinage	Green wire	Avvolgimento	Green wire
11	Lower bracket	Cast iron	Support inférieur	Fonte grise	Supporto inferiore	Ghisa grigia
12	Mechanical seal cover	Cast iron	mécanique d'étanchéité	Fonte grise	Coperchio tenuta meccanica	Ghisa grigia
13	Mechanical seal	Silicon carbide/silicon carbide	Garniture mécanique	Carbure de silicium/ carbure de silicium	Tenuta meccanica	Carburo di silicio/ carburo di silicio
14	Bearing bush	Bronze	Coussinet	Bronze	Bronzina	Bronzo
14 (15)	Bearing bush (MAC8150)	Graphite	Coussinet (MAC8150)	Graphite	Bronzina (MAC8150)	Grafite
16	Thrust-bearing	HT	Butée	HT	Reggispinta	HT
17	Thrust-bearing foot slip	Cast iron	Support butée	Fonte grise	Supporto reggispinta	Ghisa grigia
18	Diaphragm	Rubber	Membrane	Caoutchouc	Membrana	Gomma
19	Diaphragm cover	Cast iron	Couvercle de membrane	Fonte grise	Coperchio membrana	Ghisa grigia
20	Connecting flange	Cast iron	Support intermediaire	Fonte grise	Elemento di raccordo	Ghisa grigia
22 (24)	Shaft sleeve	Chrome plated steel	Chemise d'arbre	Acier cromé	Bussola	Acciaio cromato
23	Motor bracket	Cast iron	Support moteur	Fonte grise	Disco di guida	Ghisa grigia

Bolts and nuts in stainless steel.

Visserie en acier inox

Bulloneria in acciaio inox

# E6-18

## MAC10/1A

Motor construction and materials  
 Construction du moteur et matériaux  
 Costruzione motore e materiali

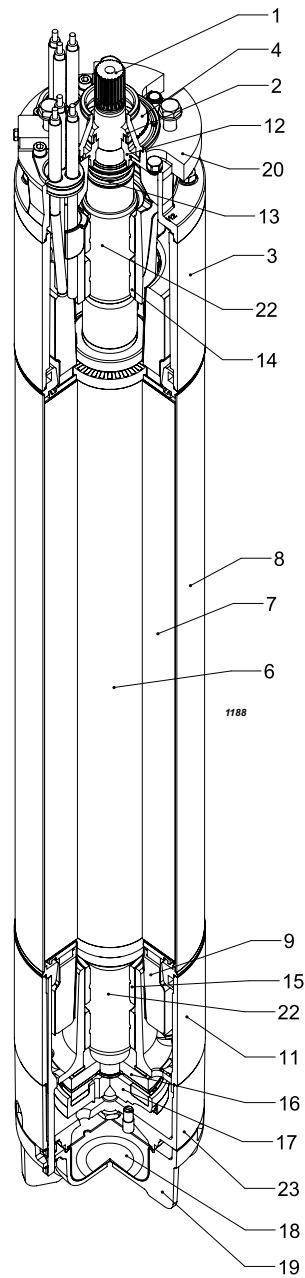

Pos.	Parts	Materials	Nomenclature	Matériaux	Nomenclatura	Materiale
1	Shaft	Stainless steel	Arbre	Acier inox	Albero	Acciaio inox
2	Sand guard	Rubber	para-sable	Caoutchouc	Parasabbia	Gomma
3	Upper bracket	Cast iron	Support supérieur	Fonte grise	Supporto superiore	Ghisa grigia
6	Rotor	Electrical steel	Rotor	Tôle magnétique	Rotore	Lamierino magnetico
7	Stator	Electrical steel	Stator	Tôle magnétique	Statore	Lamierino magnetico
8	Stator shell	Stainless steel	Chemise de stator	Acier inox	Camicia statore	Acciaio inox
9	Winding	Green wire	Bobinage	Green wire	Avvolgimento	Green wire
11	Lower bracket	Cast iron	Support inférieur	Fonte grise	Supporto inferiore	Ghisa grigia
13	Mechanical seal	Silicon carbide/silicon carbide	Garniture mécanique	Carbure de silicium/ carbure de silicium	Tenuta meccanica	Carburo di silicio/ carburo di silicio
14 (15)	Bearing bush	Bronze	Coussinet	Bronze	Bronzina	Bronzo
14 (15)	Bearing bush (MAC10250A)	Graphite	Coussinet (MAC10250A)	Graphite	Bronzina (MAC10250A)	Grafite
16	Thrust-bearing	Stainless steel/ Synthetic compound	Butée	Acier inox/Composé synthétique	Reggispinta	Acciaio inox/ Composito sintetico
17	Thrust-bearing foot slip	Cast iron	Support butée	Fonte grise	Supporto reggispinta	Ghisa grigia
18	Diaphragm	Rubber	Membrane	Caoutchouc	Membrana	Gomma
19	Diaphragm cover	Cast iron	Couvercle de membrane	Fonte grise	Coperchio membrana	Ghisa grigia
20	Connecting flange	Cast iron	Support intermédiaire	Fonte grise	Elemento di raccordo	Ghisa grigia
22	Shaft sleeve	Chrome plated steel	Chemise d'arbre	Acier chromé	Bussola	Acciaio cromato
23	Motor bracket	Cast iron	Support moteur	Fonte grise	Fondello motore	Ghisa grigia

Bolts and nuts in stainless steel.  
 Cables outlet: see "Cables outlet"

Visserie en acier inox  
 Sortie câbles voir "Sortie câbles"

Bulloneria in acciaio inox  
 Uscita cavi: vedere "uscita cavi"

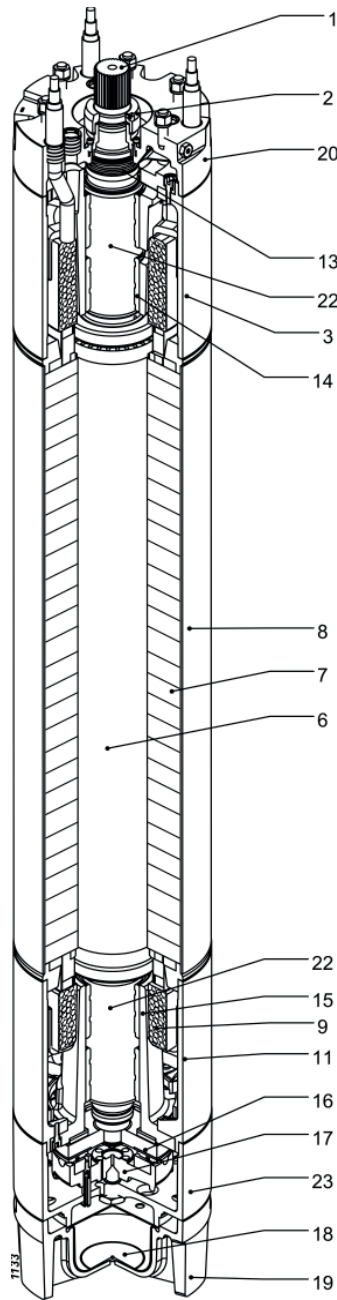

Pos.	Parts	Materials	Nomenclature	Matériaux	Nomenclatura	Materiale
1	Shaft	Stainless steel	Arbre	Acier inox	Albero	Acciaio inox
2	Sand guard	Bronze	para-sable	Bronze	Parasabbia	Bronzo
3	Upper bracket	Cast iron	Support supérieur	Fonte grise	Supporto superiore	Ghisa grigia
6	Rotor	Electrical steel	Rotor	Tôle magnétique	Rotore	Lamierino magnetico
7	Stator	Electrical steel	Stator	Tôle magnétique	Statore	Lamierino magnetico
8	Stator shell	Stainless steel	Chemise de stator	Acier inox	Camicia statore	Acciaio inox
9	Winding	Green wire	Bobinage	Green wire	Avvolgimento	Green wire
9	Winding (MAC12/C)	PE2+PA	Bobinage (MAC12/C)	PE2+PA	Avvolgimento (MAC12/C)	PE2+PA
11	Lower bracket	Cast iron	Support inférieur	Fonte grise	Supporto inferiore	Ghisa grigia
13	Mechanical seal	Silicon carbide/silicon carbide	Garniture mécanique	Carbure de silicium/ carbure de silicium	Tenuta meccanica	Carburo di silicio/ carburo di silicio
14 (15)	Bearing	Graphite	Coussinet	Graphite	Cuscinetto	Grafite
16	Thrust-bearing	Stainless steel/ Synthetic compound	Butée	Acier inox/Composé synthétique	Reggispinta	Acciaio inox/ Composito sintetico
17	Thrust-bearing foot slip	Cast iron	Support butée	Fonte grise	Supporto reggispinta	Ghisa grigia
18	Diaphragm	Rubber	Membrane	Caoutchouc	Membrana	Gomma
19	Diaphragm cover	Cast iron	Couvercle de membrane	Fonte grise	Coperchio membrana	Ghisa grigia
20	Connecting flange	Cast iron	Support intermediaire	Fonte grise	Elemento di raccordo	Ghisa grigia
22	Shaft sleeve	Chrome plated steel	Chemise d'arbre	Acier cromé	Bussola	Acciaio cromato
23	Motor bracket	Cast iron	Support moteur	Fonte grise	Fondello motore	Ghisa grigia

Bolts and nuts in stainless steel.  
Cables outlet: see "Cables outlet"

Visserie en acier inox  
Sortie câbles voir "Sortie câbles"

Bulloneria in acciaio inox  
Uscita cavi: vedere "uscite cavi"

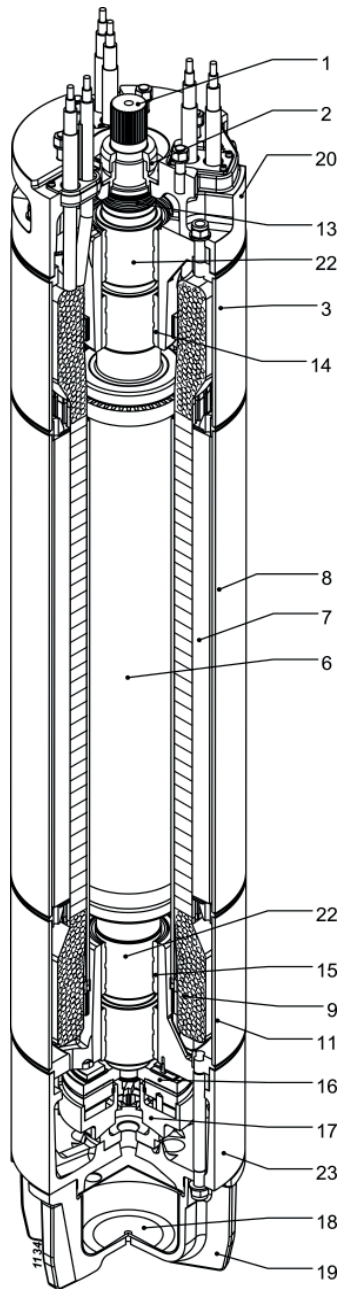

Pos.	Parts	Materials	Nomenclature	Matériaux	Nomenclatura	Materiale
1	Shaft	Stainless steel	Arbre	Acier inox	Albero	Acciaio inox
2	Sand guard	Stainless steel	para-sable	Acier inox	Parasabbia	Acciaio inox
3	Upper bracket	Cast iron	Support supérieur	Fonte grise	Supporto superiore	Ghisa grigia
6	Rotor	Electrical steel	Rotor	Tôle magnétique	Rotore	Lamierino magnetico
7	Stator	Electrical steel	Stator	Tôle magnétique	Statore	Lamierino magnetico
8	Stator shell	Stainless steel	Chemise de stator	Acier inox	Camicia statore	Acciaio inox
9	Winding	PE2+PA	Bobinage	PE2+PA	Avvolgimento	PE2+PA
11	Lower bracket	Cast iron	Support inférieur	Fonte grise	Supporto inferiore	Ghisa grigia
13	Mechanical seal	Silicon carbide/silicon carbide	Garniture mécanique	Carbure de silicium/ carbure de silicium	Tenuta meccanica	Carburo di silicio/ carburo di silicio
14 (15)	Bearing bush	Bronze	Coussinet	Bronze	Bronzina	Bronzo
14 (15)	Bearing bush (M14540:600)	Graphite	Coussinet (M14540:600)	Graphite	Bronzina (M14540:600)	Grafite
16	Thrust-bearing	Brass/Synthetic compound	Butée	Laiton/Composé synthétique	Reggispinta	Ottone/Composito sintetico
17	Thrust-bearing foot slip	Nodular cast iron	Support butée	Fonte sphéroïdale	Supporto reggispinta	Ghisa sferoidale
18	Diaphragm	Rubber	Membrane	Caoutchouc	Membrana	Gomma
19	Diaphragm cover	Cast iron	Couvercle de membrane	Fonte grise	Coperchio membrana	Ghisa grigia
20	Connecting flange	Nodular cast iron	Support intermédiaire	Fonte sphéroïdale	Elemento di raccordo	Ghisa sferoidale
22	Shaft sleeve	Chrome plated steel	Chemise d'arbre	Acier cromé	Bussola	Acciaio cromato
23	Motor bracket	Nodular cast iron	Support moteur	Fonte sphéroïdale	Fondello motore	Ghisa sferoidale

Bolts and nuts in stainless steel.  
Cables outlet: see "Cables outlet"

Visserie en acier inox  
Sortie câbles voir "Sortie câbles"

Bulloneria in acciaio inox  
Uscita cavi: vedere "uscita cavi"

- a) The standard construction electric submersible pumps series E6-18 are suitable for raising chemically and mechanically non-aggressive water.
- b) Maximum content of solids, the same hardness and granulometry of silt:  
 40 [g/m<sup>3</sup>]  
 E6P/E8P 100 [g/m<sup>3</sup>]
- c) Maximum operating time when the outlet is closed and the pump is submersed: 3 min.
- d) The hydraulic performance characteristics were measured with 400 V powered motors, cold water (15°C) and atmospheric pressure (1 bar). They are guaranteed as conforming to standard UNI/ISO 9906 Grade 3B.

The catalogue given data refer to liquids with a density of 1 [kg/dm<sup>3</sup>] and kinematic viscosity of not more than 1 [mm<sup>2</sup>/s], are comprehensive of friction losses in the check valves of radial pumps; in case of mixed-flow pumps, friction losses must, on the contrary, be deduced from the total head shown on the catalogue (see chart on page Friction losses).

- e) UPON REQUEST
  - Pumps can be tested according to UNI/ISO 9906 Grade 1B. UNI/ISO 9906 Grade 2B.
  - Pumps having characteristics differing from those shown in the catalogue can be supplied.
  - Special executions can be supplied with:
    - with bronze and/stainless steel impellers
    - with bronze and/stainless steel casing and impellers
    - metallic stage casings and impellers instead of thermoplastic resin (E8R35-40);
    - 4 pole motors up to 22";
    - for horizontal installation, if not usually foreseen.

- a) *Les électropompes immergées série E6-18, dans leur version normale de construction, sont aptes au pompage d'eau chimiquement et mécaniquement non agressive pour les matériaux des composants.*
- b) *Contenu maximum des substances solides de la dureté et la granulométrie du limon: 40 [g/m<sup>3</sup>]. E6P/E8P 100 [g/m<sup>3</sup>]*
- c) *Temps maximum de fonctionnement, à vanne fermée et pompe submergée: 3 min.*
- d) *Les caractéristiques hydrauliques de fonctionnement ont été mesurées avec des moteurs à 400 V, avec de l'eau froide (15° C) à une pression atmosphérique (1bar). Elles sont garanties conformes à la norme UNI/ISO 9906 Niveau 3B.*

*Les données du catalogue se réfèrent à un liquide pompé de densité de 1 [kg/dm<sup>3</sup>] et avec une viscosité cinématique non supérieure à 1 [mm<sup>2</sup>/s].*

*Elles comprennent les pertes de charge dans les clapets de retenue des pompes radiales. Pour les pompes semi-axiales, les pertes doivent être déduites de la hauteur manométrique totale indiquée dans le catalogue (voir diagramme page Pertes de charge).*

- e) SUR DEMANDE
  - *Les pompes peuvent être testées selon les normes UNI/ISO 9906 Niveau 1B. UNI/ISO 9906 Niveau 2B.*
  - *Nous pouvons fournir des électropompes de caractéristiques différentes de celles du catalogue.*
  - *Nous pouvons fournir des exécutions spéciales:*
    - *avec roues en bronze et/ou inox*
    - *avec corps et roues en bronze et/ou inox*
    - *avec parties intérieures métalliques à la place de résine thermoplastique (E8R35-40);*
    - *pour moteurs 4 pôles jusqu'à 22";*
    - *pour installation horizontale si pas normalement prévue.*

- a) Le elettropompe sommerse serie E6-18, nella normale versione costruttiva, sono adatte al sollevamento di acqua chimicamente e meccanicamente non aggressiva per i materiali dei componenti.
- b) Contenuto massimo di sostanze solide della durezza e granulometria del limo: 40 [g/m<sup>3</sup>]. E6P/E8P 100 [g/m<sup>3</sup>]
- c) Tempo massimo di funzionamento a bocca chiusa e pompa sommersa: 3 min.
- d) Le caratteristiche idrauliche di funzionamento sono state rilevate con motori alimentati a 400 V, con acqua fredda (15° C) alla pressione atmosferica (1bar). Vengono garantite secondo la norma UNI/ISO 9906 Grado 3B.

I dati di catalogo si riferiscono a liquidi con densità di 1 [kg/dm<sup>3</sup>] e con viscosità cinematica non superiore a 1 [mm<sup>2</sup>/s], e sono comprensivi delle perdite di carico nelle valvole di ritegno per le pompe radiali; per le pompe semiassiali, tali perdite devono essere invece detratte dalla prevalenza totale esposta in catalogo (vedi diagramma pagina Perdite di carico).

- e) SU RICHIESTA
  - Possono essere collaudate secondo le norme: UNI/ISO 9906 Grado 1B. UNI/ISO 9906 Grado 2B.
  - Possono essere fornite elettropompe con caratteristiche diverse da quelle a catalogo.
  - Possono essere fornite esecuzioni speciali:
    - con giranti in bronzo e/o inox;
    - con corpi e giranti in bronzo e/o inox;
    - con interni metallici anziché in resina termoplastica (E8R35-40);
    - per motori 4 poli fino a 22";
    - per installazione in orizzontale, quando non già prevista.

Motor general remarks  
Notes générales moteur  
Note generali motore

- a) Maximum submersion: 150 [m]  
Speed of the water outside the jacket of the motor higher:  
0,2 m/s for motors MPC6...  
0,3 m/s for motors M14...  
0,5 m/s for motors MAC... (6"-12") - MPC8... - MPC10...
- Max temperature liquid  
MPC6... = 30°C  
MPC8... - MPC10... = 25°C  
MAC6... A = 40°C (5 - 20 cv)  
MAC6... A = 35°C (25 - 40 cv)  
MAC6... A = 30°C (50 cv)  
MAC6... B = 45°C (5 - 20 cv)  
MAC6... B = 40°C (25 - 40 cv)  
MAC6... B = 35°C (50 - 60 cv)  
MAC8... = 30°C  
MAC10... = 25°C  
MAC12... = 25°C  
M14... = 25°C
- b) STANDARD VERSION - THREE-PHASE/  
50 Hz supply voltage  
Direct starting:  
6"-12": MAC...-8;  
400 V for all power outputs  
14": M...-8;  
400 V for all power outputs  
All motors are suitable for the operation with inverters, by respecting the instructions provided in the use and maintenance manual (MUM) (contact the sales network).
- c) VERSION ON REQUEST  
MPC6.../3A  
standard motor  
MPC8.../1A  
standard motor  
MPC10.../1A  
standard motor  
MAC6.../3A - /3B  
Standard motor with high efficiency (Motors used in the units specified in the catalogue)  
MAC6.../3C  
Submersible motor specified for high temperature  
MAC8.../C - MAC10.../C - MAC12.../C  
Submersible motor specified for high temperature  
MPC6.../K - MPC8.../K - MPC10.../K  
Submersible motor specified for high temperature  
For any further information please do not hesitate to contact our service network.  
THREE-PHASE/50 Hz supply voltage  
6": MPC...-8 400 V up to 37 kW,  
MPC...-9 400/700 V up to 37 kW  
MAC...-6 230 V up to 30 kW,  
MAC...-7 230/400 V up to 45 kW  
(37 kW MAC6.../3A)  
MAC...-8 400 V up to 45 kW,  
MAC...-9 400/700 V up to 45 kW  
(37 kW MAC6.../3A)  
(4 - 45 kW MAC6.../3C)  
8": MPC...-8 400 V up to 92 kW,  
MPC...-9 400/700 V up to 92 kW  
MAC...-6 230 V up to 75 kW,  
MAC...-7 230/400 V up to 75 kW,  
MAC...-8 400 V up to 110 kW,  
MAC...-9 400/700 V up to 110 kW  
10": MPC...-8 400 V up to 150 kW,  
MPC...-9 400/700 V up to 150 kW  
MAC...-6 230 V up to 110 kW,  
MAC...-7 230/400 V up to 132 kW,  
MAC...-8 400 V up to 185 kW,  
MAC...-9 400 V up to 185 kW  
12": MAC...-9 400 V up to 280 kW,  
14": M...-8 400 V up to 450 kW,  
In addition, motors can be supplied:  
- for other voltages and frequencies  
- with special winding for hot water (already standard on MAC12300 and M14).
- a) Immersion maximum : 150 [m]  
Vitesse de l'eau à l'extérieur de la chemise du moteur supérieure à :  
0,2 m/s pour moteurs MPC6...  
0,3 m/s pour moteurs M14...  
0,5 m/s pour moteurs MAC... (6"-12") - MPC8...-MPC10...
- Température Max liquide  
MPC6... = 30°C  
MPC8... - MPC10... = 25°C  
MAC6... A = 40°C (5 - 20 cv)  
MAC6... A = 35°C (25 - 40 cv)  
MAC6... A = 30°C (50 cv)  
MAC6... B = 45°C (5 - 20 cv)  
MAC6... B = 40°C (25 - 40 cv)  
MAC6... B = 35°C (50 - 60 cv)  
MAC8... = 30°C  
MAC10... = 25°C  
MAC12... = 25°C  
M14... = 25°C
- b) EXECUTION STANDARD - Tension d'alimentation TRIPHASEE/50 Hz  
Démarriage direct :  
6"-12": MAC...-8;  
400 V pour toutes les puissances  
14": M...-8  
400 V pour toutes les puissances  
Tous les moteurs sont conformes au fonctionnement avec onduleur, selon les prescriptions figurant dans le Manuel d'utilisation et d'entretien (MUM). (contacter le réseau de vente).
- c) EXECUTION SUR DEMANDE -  
MPC6.../3A  
moteur standard  
MPC8.../1A  
moteur standard  
MPC10.../1A  
moteur standard  
MAC6.../3A - /3B  
Moteur standard avec prestations élevées. (moteurs utilisés dans les groupes figurant sur le catalogue)  
MAC6.../3C  
Moteur submersible spécifique pour utilisation à haute température  
MAC8.../C - MAC10.../C - MAC12.../C  
Moteur submersible spécifique pour utilisation à haute température  
MPC6.../K - MPC8.../K - MPC10.../K  
Moteur submersible spécifique pour utilisation à haute température  
Pour toute information complémentaire, n'hésitez pas à contacter notre réseau de vente.  
Tension d'alimentation TRIPHASEE/50 Hz  
6": MPC...-8 400 V jusqu'à 37 kW,  
MPC...-9 400/700 V jusqu'à 37 kW  
MAC...-6 230 V jusqu'à 30 kW,  
MAC...-7 230/400 V jusqu'à 45 kW  
(37 kW MAC6.../3A)  
MAC...-8 400 V jusqu'à 45 kW,  
MAC...-9 400/700 V jusqu'à 45 kW  
(37 kW MAC6.../3A)  
(4 - 45 kW MAC6.../3C)  
8": MPC...-8 400 V jusqu'à 92 kW,  
MPC...-9 400/700 V jusqu'à 92 kW  
MAC...-6 230 V jusqu'à 75 kW,  
MAC...-7 230/400 V jusqu'à 75 kW,  
MAC...-8 400 V jusqu'à 110 kW,  
MAC...-9 400/700 V jusqu'à 110 kW  
10": MPC...-8 400 V jusqu'à 150 kW,  
MPC...-9 400/700 V jusqu'à 150 kW  
MAC...-6 230 V jusqu'à 110 kW,  
MAC...-7 230/400 V jusqu'à 132 kW,  
MAC...-8 400 V jusqu'à 185 kW,  
MAC...-9 400 V jusqu'à 185 kW  
12": MAC...-9 400 V jusqu'à 280 kW,  
14": M...-8 400 V jusqu'à 450 kW,  
En outre, des moteurs peuvent être fournis :  
- pour tensions et fréquences différentes  
- avec bobinage spécial pour eau chaude (déjà standard sur MAC12300 et M14).
- a) Battente massimo: 150 [m]  
Velocità dell'acqua all'esterno della camicia del motore superiore:  
0,2 m/s per motori MPC6...  
0,3 m/s per motori M14...  
0,5 m/s per motori MAC... (6"-12") - MPC8...-MPC10...  
Temperatura Max liquido  
MPC6... = 30°C  
MPC8... - MPC10... = 25°C  
MAC6... A = 40°C (5 - 20 cv)  
MAC6... A = 35°C (25 - 40 cv)  
MAC6... A = 30°C (50 cv)  
MAC6... B = 45°C (5 - 20 cv)  
MAC6... B = 40°C (25 - 40 cv)  
MAC6... B = 35°C (50 - 60 cv)  
MAC8... = 30°C  
MAC10... = 25°C  
MAC12... = 25°C  
M14... = 25°C
- b) ESECUZIONE STANDARD - Tensione di alimentazione TRIFASE/50 Hz  
Avviamento diretto:  
6"-12": MAC...-8;  
400V per tutte le potenze  
14": M...-8;  
400 V per tutte le potenze  
Tutti i motori sono idonei al funzionamento con inverter, seguendo le prescrizioni presenti nel MUM. (contattare la rete di vendita)
- c) ESECUZIONI DISPONIBILI  
MPC6.../3A  
motore standard  
MPC8.../1A  
motore standard  
MPC10.../1A  
motore standard  
MAC6.../3A - /3B  
Motori standard ad alte prestazioni (motori impiegati nei gruppi a catalogo)  
MAC6.../3C  
Motore sommerso per utilizzo ad alte temperature.  
MAC8.../C - MAC10.../C - MAC12.../C  
Motore sommerso per utilizzo ad alte Temperature.  
MPC6.../K - MPC8.../K - MPC10.../K  
Motore sommerso per utilizzo ad alte Temperature.  
Per ulteriori informazioni contattare la nostra rete di vendita  
Tensione di alimentazione TRIFASE/50 Hz  
6": MPC...-8 400 V fino a 37 kW,  
MPC...-9 400/700 V fino a 37 kW  
MAC...-6 230 V fino a 30 kW,  
MAC...-7 230/400 V fino a 45 kW  
(37 kW MAC6.../3A)  
MAC...-8 400 V fino a 45 kW,  
MAC...-9 400/700 V fino a 45 kW  
(37 kW MAC6.../3A)  
(4 - 45 kW MAC6.../3C)  
8": MPC...-8 400 V fino a 92 kW,  
MPC...-9 400/700 V fino a 92 kW  
MAC...-6 230 V fino a 75 kW,  
MAC...-7 230/400 V fino a 75 kW,  
MAC...-8 400 V fino a 110 kW,  
MAC...-9 400/700 V fino a 110 kW  
10": MPC...-8 400 V fino a 150 kW,  
MPC...-9 400/700 V fino a 150 kW  
MAC...-6 230 V fino a 110 kW,  
MAC...-7 230/400 V fino a 132 kW,  
MAC...-8 400 V fino a 185 kW,  
MAC...-9 400 V fino a 185 kW  
12": MAC...-9 400 V fino a 280 kW,  
14": M...-8 400 V fino a 450 kW,  
Possono inoltre essere forniti motori:  
- per tensioni e frequenze diverse  
- con avvolgimento speciale per acqua calda già standard da MAC12300 e M14).  
- con materiali speciali per acqua aggressiva.



Motor general remarks  
Notes generales moteur  
Note generali motore

- with special materials for aggressive water
- d) Permissible variations on the stated supply voltages without brackets:  
6"-10": (220 V), 230 V, (240 V)  $\pm$  10%  
6"-14": (380 V), 400 V, (415 V)  $\pm$  10%  
6"-14": for other voltages and frequencies  $\pm$  5%

Tolerances on the operating data: according to the International Standards IEC 34-1.

Thermal probes on request

- MPC6" with 5 [m] of cable outlet
- MPC8"-10" with 4 [m] of cable outlet
- MAC6" with 5 [m] of cable outlet
- MAC6"-8"-10" with 4 [m] of cable outlet.
- MAC12" with 6 [m] of cable outlet
- MAC12"-14" with 5 [m] of cable outlet.

- avec matériaux spéciaux pour eau agressive.
- d) Variations admises sur les tensions d'alimentation indiquées sans parenthèses :  
6"-10": (220 V), 230 V, (240 V)  $\pm$  10%  
6"-14": (380 V), 400 V, (415 V)  $\pm$  10%  
6"-14 " : pour tensions et fréquences différentes  $\pm$  5%

Tolérances sur les caractéristiques de fonctionnement :  
selon les normes internationales IEC 34-1.

Sondes thermiques sur demande:

- MPC6" avec 5 [m] de sortie de câble
- MPC8"-10" avec 4 [m] de sortie de câble
- MAC6" avec 5 [m] de sortie de câble
- MAC6"-8"-10" avec 4 [m] de sortie de câble.
- MAC12" avec 6 [m] de sortie de câble
- MAC12"-14" avec 5 [m] de sortie de câble.

- d) **Variazioni ammesse sulle tensioni di alimentazione indicate senza parentesi:**  
6"-10": (220 V), 230 V, (240 V)  $\pm$  10%  
6"-14": (380 V), 400 V, (415 V)  $\pm$  10%  
6"-14": per tensioni/frequenze diverse  $\pm$  5%

**Tolleranze sulle caratteristiche di funzionamento:**  
secondo le Norme Internazionali IEC 34-1.

**Sonde termiche su richiesta:**

- MPC6" con 5 [m] di cavo uscente**
- MPC8"-10" con 4 [m] di cavo uscente**
- MAC6" con 5 [m] di cavo uscente**
- MAC8"-10" con 4 [m] di cavo uscente**
- MAC12" con 6 [m] di cavo uscente**
- MAC12"-14" con 5 [m] di cavo uscente.**

Performance ranges  
*Champs de performances*  
 Campi di prestazioni

Performance ranges at 2 Poles / 50 Hz  
*Champs de performances à 2 Pôles / 50 Hz*  
 Campi di prestazioni a 2 Poli / 50 Hz

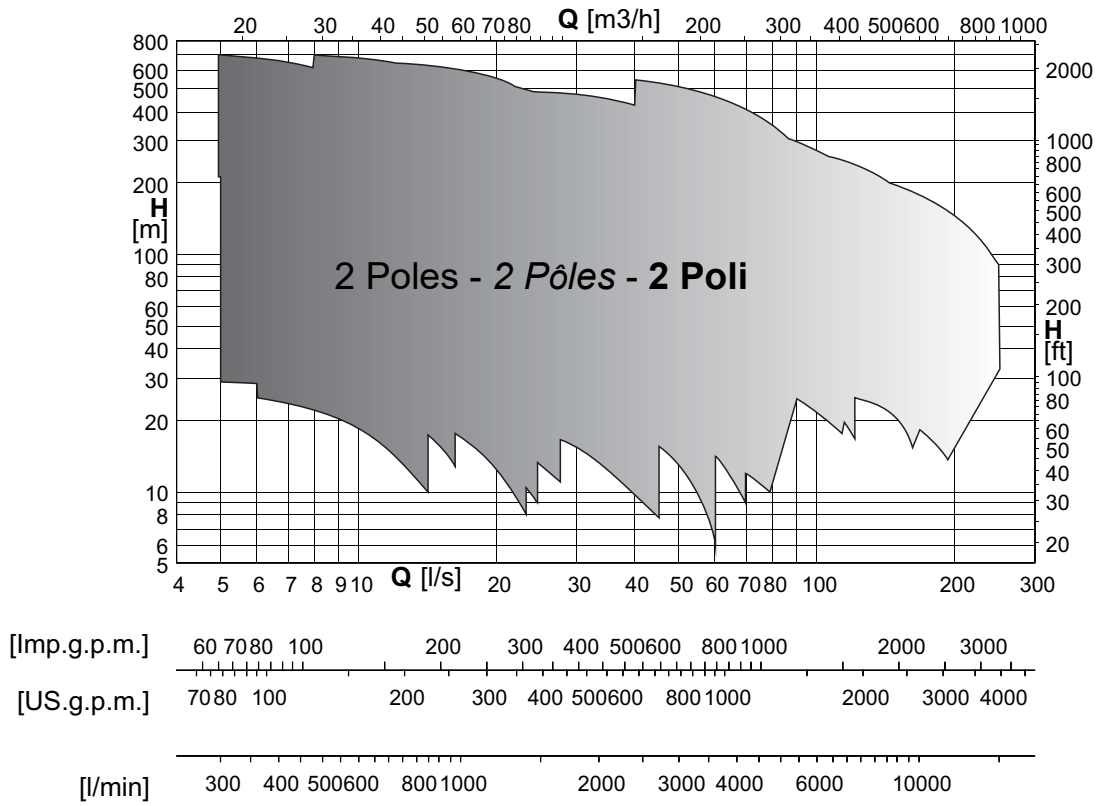

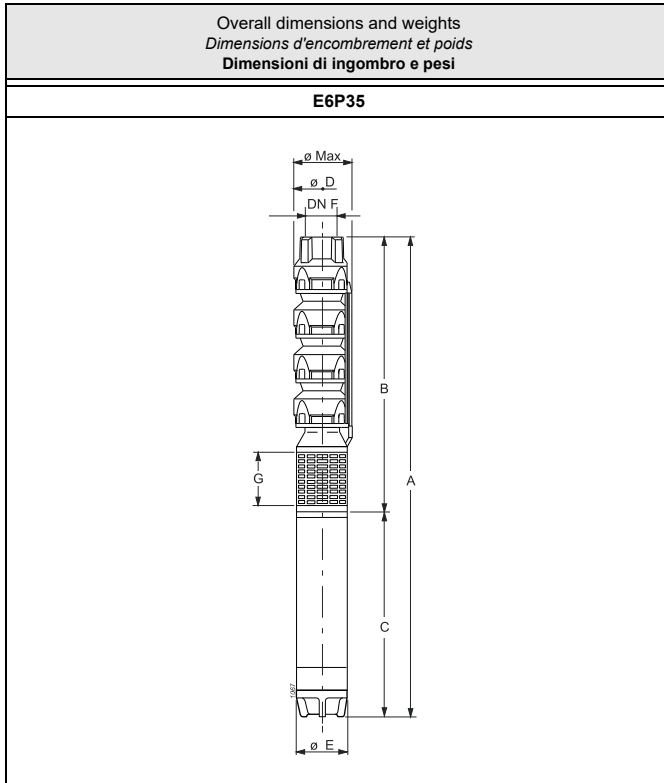

Type Type Tipo	Ø max [mm]	Weight Poids Peso [kg]	A	B	C	D	E	G	F
			[mm]						
E6P35/3I+MAC65A	150	65,5	1244	674	570	145,5	143	122	G3
E6P35/4I+MAC67A	150	76,5	1404	789	615	145,5	143	122	G3
E6P35/6L+MAC610A	150	93,5	1689	1019	670	145,5	143	122	G3
E6P35/7N+MAC612A	150	102,5	1834	1134	700	145,5	143	122	G3
E6P35/8A+MAC615A	150	113	1964	1249	715	145,5	143	122	G3
E6P35/10M+MAC617A	150	129	2229	1479	750	145,5	143	122	G3
E6P35/11I+MAC620A	150	139	2384	1594	790	145,5	143	122	G3
E6P35/12A+MAC625A	150	149	2539	1709	830	145,5	143	122	G3
E6P35/14M+MAC625A	150	161	2769	1939	830	145,5	143	122	G3
E6P35/15A+MAC630A	150	177,5	2974	2054	920	145,5	143	122	G3
E6P35/16A+MAC630A	150	183,5	3104	2184	920	145,5	143	122	G3
E6P35/17A+MAC635A	150	204,5	3354	2299	1055	145,5	143	122	G3
E6P35/19A+MAC635A	150	216,5	3584	2529	1055	145,5	143	122	G3
E6P35/21A+MAC640A	150	241	3924	2759	1165	145,5	143	122	G3
E6P35/22A+MAC640A	150	247	4039	2874	1165	145,5	143	122	G3
E6P35/24A+MAC650B	150	276	4386	3104	1282	145,5	143	122	G3
E6P35/25A+MAC650B	150	282	4501	3219	1282	145,5	143	122	G3
E6P35/27A+MAC650B	150	294	4731	3449	1282	145,5	143	122	G3
E6P35/30A+MAC660B	150	316,5	5116	3794	1322	145,5	143	122	G3
E6P35/32A+MAC660B	150	328,5	5346	4024	1322	145,5	143	122	G3

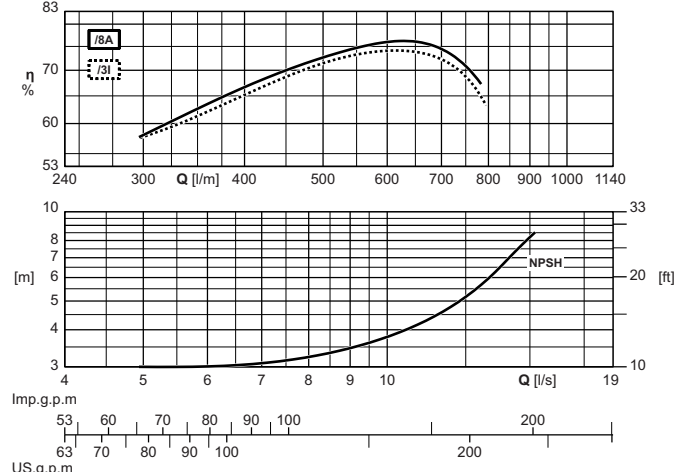
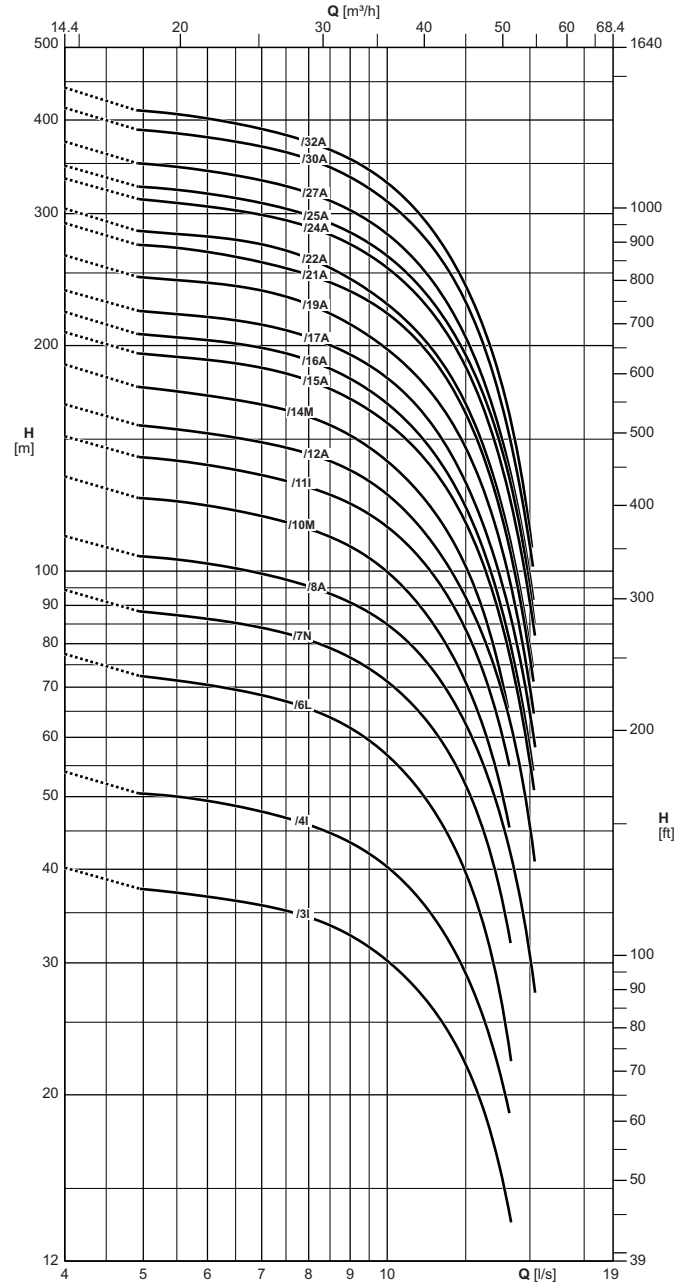

The hydraulic performance characteristics are guaranteed as conforming to standard UNI/ISO 9906 Grade 3B.  
Available with NPT thread.

Les caractéristiques hydrauliques de fonctionnement sont garanties conformes à la norme UNI/ISO 9906 Niveau 3B.  
Disponible avec filetage NPT.

Le caratteristiche di funzionamento vengono garantite secondo la norma: UNI/ISO 9906 Grado 3B.  
Disponibile con filettatura NPT.

Electric pump type Electropompe type Elettropompa tipo	Motor power Puis. moteur Potenza motore		Horizontal installation Installation horizontale Installazione orizzontale	Check valve $\varnothing$ Clapet de retenue $\varnothing$ Valvola di ritegno $\varnothing$	Capacity Debit Portata												
	[kW]	[HP]			[l/s]	0	5	6	7	8	9	10	11	12	13	14	15
					[l/min]	0	300	360	420	480	540	600	660	720	780	840	900
					[m <sup>3</sup> /h]	0	18	21,6	25,2	28,8	32,4	36	39,6	43,2	46,8	50,4	54
		Head Hauteur Prevalenza															
		[m]	40	37,5	36,5	36	34,5	32,5	30	27,5	24	20	14,5	-			
E6P35/3I+MAC65A	4	5,5	■	3" Gas	[m]	40	37,5	36,5	36	34,5	32,5	30	27,5	24	20	14,5	-
E6P35/4I+MAC67A	5,5	7,5	■	3" Gas	[m]	54	50	49,5	48	45,5	43,5	40,5	36,5	31,5	26,5	20	-
E6P35/6L+MAC610A	7,5	10	■	3" Gas	[m]	77	72	70	68	65	62	57	51	44	35	24,5	-
E6P35/7N+MAC612A	9,2	12,5	■	3" Gas	[m]	94	88	86	84	81	76	71	64	56	46,5	34,5	-
E6P35/8A+MAC615A	11	15	■	3" Gas	[m]	111	104	102	99	95	91	85	77	68	57	44	30,5
E6P35/10M+MAC617A	13	17,5	■	3" Gas	[m]	134	125	122	118	113	108	100	89	77	64	49	-
E6P35/11I+MAC620A	15	20	■	3" Gas	[m]	151	142	138	134	129	123	115	104	90	76	58	-
E6P35/12A+MAC625A	18,5	25	■	3" Gas	[m]	167	156	153	148	143	136	126	114	100	83	66	46
E6P35/14M+MAC625A	18,5	25	■	3" Gas	[m]	189	176	171	166	160	152	140	126	111	90	68	-
E6P35/15A+MAC630A	22	30	■	3" Gas	[m]	208	195	191	187	180	169	157	143	125	105	81	56
E6P35/16A+MAC630A	22	30	○	3" Gas	[m]	222	207	203	199	191	180	167	151	132	110	85	57
E6P35/17A+MAC635A	26	35	○	3" Gas	[m]	237	222	218	213	205	194	181	164	143	119	91	64
E6P35/19A+MAC635A	26	35	○	3" Gas	[m]	264	246	242	237	227	213	198	180	158	132	103	70
E6P35/21A+MAC640A	30	40	○	3" Gas	[m]	291	272	267	258	249	236	221	200	176	147	113	78
E6P35/22A+MAC640A	30	40	○	3" Gas	[m]	305	284	280	273	261	245	228	206	181	152	118	78
E6P35/24A+MAC650B	37	50	○	3" Gas	[m]	334	313	306	299	288	273	253	231	204	171	131	91
E6P35/25A+MAC650B	37	50	○	3" Gas	[m]	348	325	319	310	298	283	263	239	212	176	139	95
E6P35/27A+MAC650B	37	50	○	3" Gas	[m]	374	350	342	332	319	303	282	254	223	186	144	100
E6P35/30A+MAC660B	45	60	○	3" Gas	[m]	415	388	379	369	354	335	312	282	248	208	161	107
E6P35/32A+MAC660B	45	60	○	3" Gas	[m]	442	411	402	388	374	355	330	298	262	217	169	114
NPSH					[m]	-	3	3	3,1	3,2	3,5	3,8	4,2	5,1	5,6	6,8	8,2

M.E.I.  $\geq 0.40$

■ Without conical valve

□ On request

○ Please contact our sales organisation

For motor performances specification see page "motor features"

Temperature monitoring device for submersed electric motors 6" + 14": see page "Accessories"

■ Sans soupape du clapet.

□ Sur demande

○ Contacter notre service commercial.

Pour caractéristiques techniques moteurs voir page "Caractéristiques des moteurs"

Appareillage de contrôle de la température des moteurs électriques immergés 6" + 14": voir page "Accessories"

■ Senza clapet valvola di ritegno

□ Su richiesta

○ Interpellare la sede o la rete di vendita

Per caratteristiche motori vedere pagina "caratteristiche motori"

Apparecchiatura di controllo temperatura motori elettrici sommersi 6" + 14": vedere pagina accessori

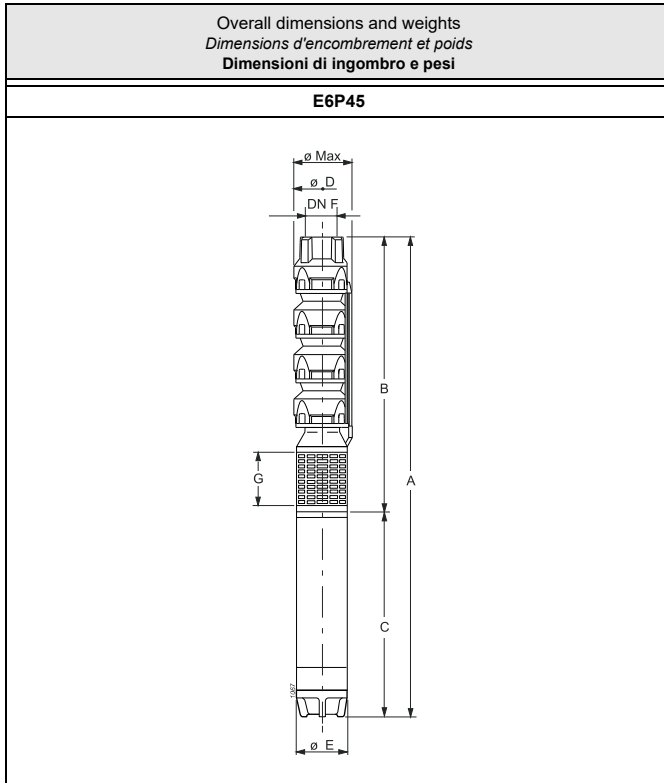

Type Type Tipo	Ø max [mm]	Weight Poids Peso [kg]	A	B	C	D	E	G	F
			[mm]						
E6P45/2I+MAC65A	150	59,5	1129	559	570	145,5	143	122	G3
E6P45/3N+MAC67A	150	70,5	1289	674	615	145,5	143	122	G3
E6P45/3A+MAC610A	150	75,5	1344	674	670	145,5	143	122	G3
E6P45/4N+MAC610A	150	81,5	1459	789	670	145,5	143	122	G3
E6P45/5U+MAC612A	150	90,5	1604	904	700	145,5	143	122	G3
E6P45/6P+MAC615A	150	101	1734	1019	715	145,5	143	122	G3
E6P45/7L+MAC617A	150	111	1884	1134	750	145,5	143	122	G3
E6P45/7A+MAC620A	150	115	1924	1134	790	145,5	143	122	G3
E6P45/8A+MAC625A	150	125	2079	1249	830	145,5	143	122	G3
E6P45/9A+MAC625A	150	131	2194	1364	830	145,5	143	122	G3
E6P45/11I+MAC630A	150	153,5	2514	1594	920	145,5	143	122	G3
E6P45/13I+MAC635A	150	180,5	2879	1824	1055	145,5	143	122	G3
E6P45/14A+MAC640A	150	199	3104	1939	1165	145,5	143	122	G3
E6P45/16A+MAC650B	150	228	3451	2169	1282	145,5	143	122	G3
E6P45/18A+MAC650B	150	240	3681	2399	1282	145,5	143	122	G3
E6P45/20A+MAC660B	150	256,5	3951	2629	1322	145,5	143	122	G3
E6P45/22A+MAC660B	150	268,5	4181	2859	1322	145,5	143	122	G3

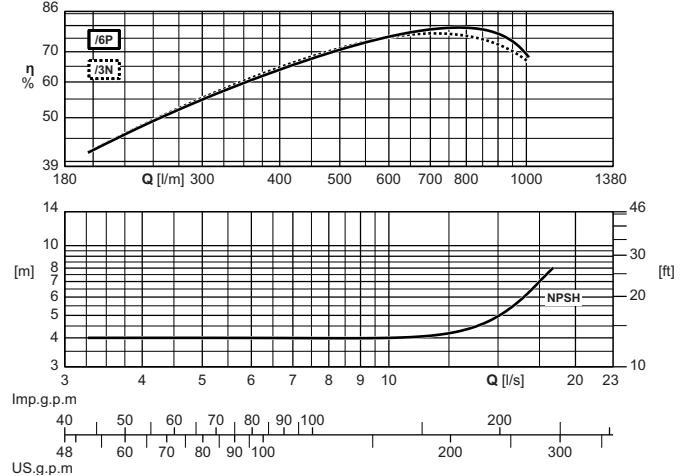
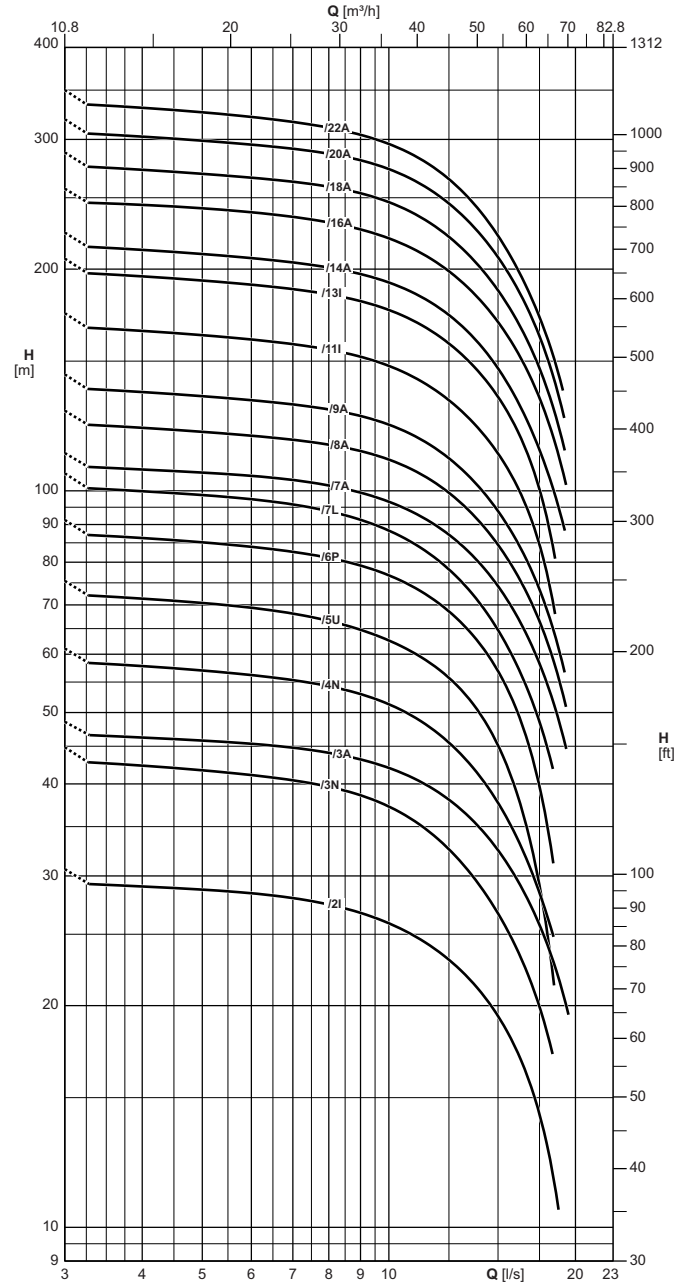

The hydraulic performance characteristics are guaranteed as conforming to standard UNI/ISO 9906 Grade 3B.  
Available with NPT thread.

Les caractéristiques hydrauliques de fonctionnement sont garanties conformes à la norme UNI/ISO 9906 Niveau 3B.  
Disponible avec filetage NPT.

Le caratteristiche di funzionamento vengono garantite secondo la norma: UNI/ISO 9906 Grado 3B.  
Disponibile con filettatura NPT.

Electric pump type Electropompe type Elettropompa tipo	Motor power Puis. moteur Potenza motore		Horizontal installation Installation horizontale Installazione orizzontale	Check valve $\varnothing$ Clapet de retenue $\varnothing$ Valvola di ritegno $\varnothing$	Capacity Debit Portata																		
	[kW]	[HP]			[l/s]	0	4	5	6	7	8	9	10	11	12	13	14	15	16	17	18	19	
					[l/min]	0	240	300	360	420	480	540	600	660	720	780	840	900	960	1020	1080	1140	
					[m <sup>3</sup> /h]	0	14,4	18	21,6	25,2	28,8	32,4	36	39,6	43,2	46,8	50,4	54	57,6	61,2	64,8	68,4	
Head Hauteur Prevalenza																							
E6P45/2I+MAC65A	4	5,5	■	3" Gas	[m]	30,5	29	28,5	28,5	28	27,5	26,5	26	25	23,5	22,5	21	19,5	17,5	15,5	13	-	
E6P45/3N+MAC67A	5,5	7,5	■	3" Gas	[m]	45	42,5	42	41	40,5	39,5	38,5	37	35,5	33,5	31,5	29	26,5	24	21,5	18,5	-	
E6P45/3A+MAC610A	7,5	10	■	3" Gas	[m]	48,5	46	46	45,5	45	44	43	42	40,5	39	37	35	32,5	30	27	24	21	
E6P45/4N+MAC610A	7,5	10	■	3" Gas	[m]	61	58	57	56	55	54	53	51	49,5	47	44	41	37,5	34	30	26,5	-	
E6P45/5U+MAC612A	9,2	12,5	■	3" Gas	[m]	75	71	70	69	68	66	65	63	60	57	54	50	45	39,5	33	25,5	-	
E6P45/6P+MAC615A	11	15	■	3" Gas	[m]	91	86	85	84	83	81	79	76	74	70	66	62	57	51	43,5	35	-	
E6P45/7L+MAC617A	13	17,5	■	3" Gas	[m]	105	100	99	97	96	94	91	88	84	80	75	70	64	58	52	45	-	
E6P45/7A+MAC620A	15	20	■	3" Gas	[m]	112	107	106	105	103	101	99	96	93	89	85	80	74	68	62	55	47	
E6P45/8A+MAC625A	18,5	25	■	3" Gas	[m]	128	122	120	119	117	115	113	110	106	102	97	90	84	77	70	62	54	
E6P45/9A+MAC625A	18,5	25	■	3" Gas	[m]	144	136	134	133	131	129	126	123	119	114	107	101	94	86	78	69	59	
E6P45/11I+MAC630A	22	30	■	3" Gas	[m]	174	165	163	160	158	155	152	148	142	136	129	121	112	102	90	76	-	
E6P45/13I+MAC635A	26	35	○	3" Gas	[m]	207	195	193	190	188	185	181	176	170	162	154	144	134	122	108	90	-	
E6P45/14A+MAC640A	30	40	○	3" Gas	[m]	224	212	209	207	204	201	197	192	185	178	168	158	146	134	120	106	91	
E6P45/16A+MAC650B	37	50	○	3" Gas	[m]	257	244	242	239	235	231	226	220	213	203	193	181	169	155	141	125	108	
E6P45/18A+MAC650B	37	50	○	3" Gas	[m]	288	273	269	266	263	259	253	247	237	227	214	201	187	172	155	137	118	
E6P45/20A+MAC660B	45	60	○	3" Gas	[m]	319	303	299	295	291	287	281	274	263	252	238	224	208	190	172	151	130	
E6P45/22A+MAC660B	45	60	○	3" Gas	[m]	350	331	326	322	317	311	304	296	285	272	257	240	222	203	182	162	139	
NPSH					[m]	-	4	4	4	4	4	4,1	4	4,2	4,4	4,6	4,7	5	5,9	6,5	7,3	8,5	

M.E.I.  $\geq$  0.40

■ Without conical valve

□ On request

○ Please contact our sales organisation

For motor performances specification see page "motor features"

Temperature monitoring device for submersed electric motors 6" + 14": see page "Accessories"

■ Sans soupape du clapet.

□ Sur demande

○ Contacter notre service commercial.

Pour caractéristiques techniques moteurs voir page "Caractéristiques des moteurs"

Appareillage de contrôle de la température des moteurs électriques immergés 6" + 14": voir page "Accessories"

■ Senza clapet valvola di ritegno

□ Su richiesta

○ Interpellare la sede o la rete di vendita

Per caratteristiche motori vedere pagina "caratteristiche motori"

Apparecchiatura di controllo temperatura motori elettrici sommersi 6" + 14": vedere pagina accessori

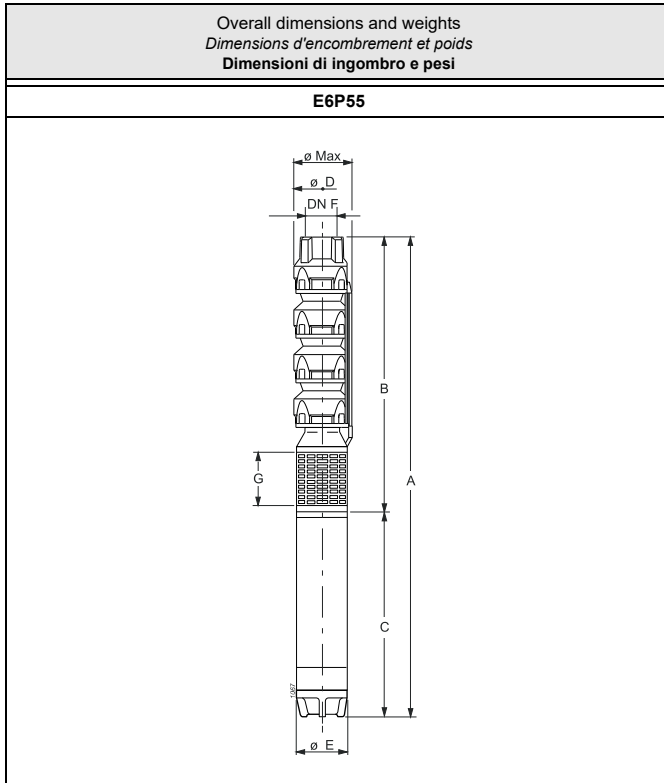

Type Type Tipo	Ø max [mm]	Weight Poids Peso [kg]	A	B	C	D	E	G	F
E6P55/2A+MAC65A	150	59,5	1129	559	570	145,5	143	122	G3
E6P55/3I+MAC67A	150	70,5	1289	674	615	145,5	143	122	G3
E6P55/4A+MAC610A	150	81,5	1459	789	670	145,5	143	122	G3
E6P55/5I+MAC612A	150	90,5	1604	904	700	145,5	143	122	G3
E6P55/6I+MAC615A	150	101	1734	1019	715	145,5	143	122	G3
E6P55/7I+MAC617A	150	111	1884	1134	750	145,5	143	122	G3
E6P55/8I+MAC620A	150	121	2039	1249	790	145,5	143	122	G3
E6P55/9A+MAC625A	150	131	2194	1364	830	145,5	143	122	G3
E6P55/10A+MAC625A	150	137	2309	1479	830	145,5	143	122	G3
E6P55/12N+MAC630A	150	159,5	2629	1709	920	145,5	143	122	G3
E6P55/13A+MAC635A	150	180,5	2879	1824	1055	145,5	143	122	G3
E6P55/14A+MAC635A	150	186,5	2994	1939	1055	145,5	143	122	G3
E6P55/15A+MAC640A	150	205	3219	2054	1165	145,5	143	122	G3
E6P55/16A+MAC640A	150	211	3334	2169	1165	145,5	143	122	G3
E6P55/17A+MAC650B	150	234	3566	2284	1282	145,5	143	122	G3
E6P55/19A+MAC650B	150	246	3796	2514	1282	145,5	143	122	G3
E6P55/21A+MAC660B	150	262,5	4066	2744	1322	145,5	143	122	G3
E6P55/23A+MAC660B	150	274,5	4296	2974	1322	145,5	143	122	G3

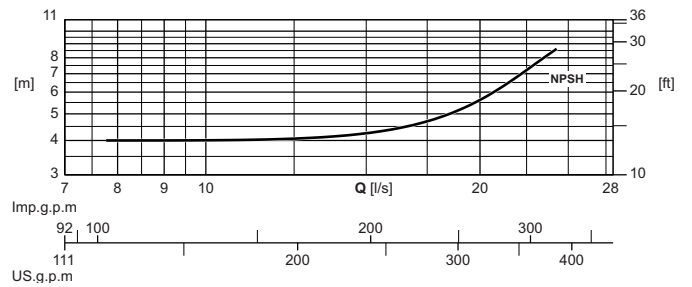
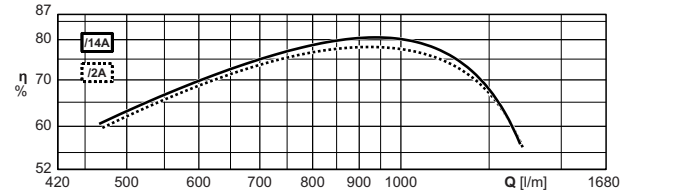
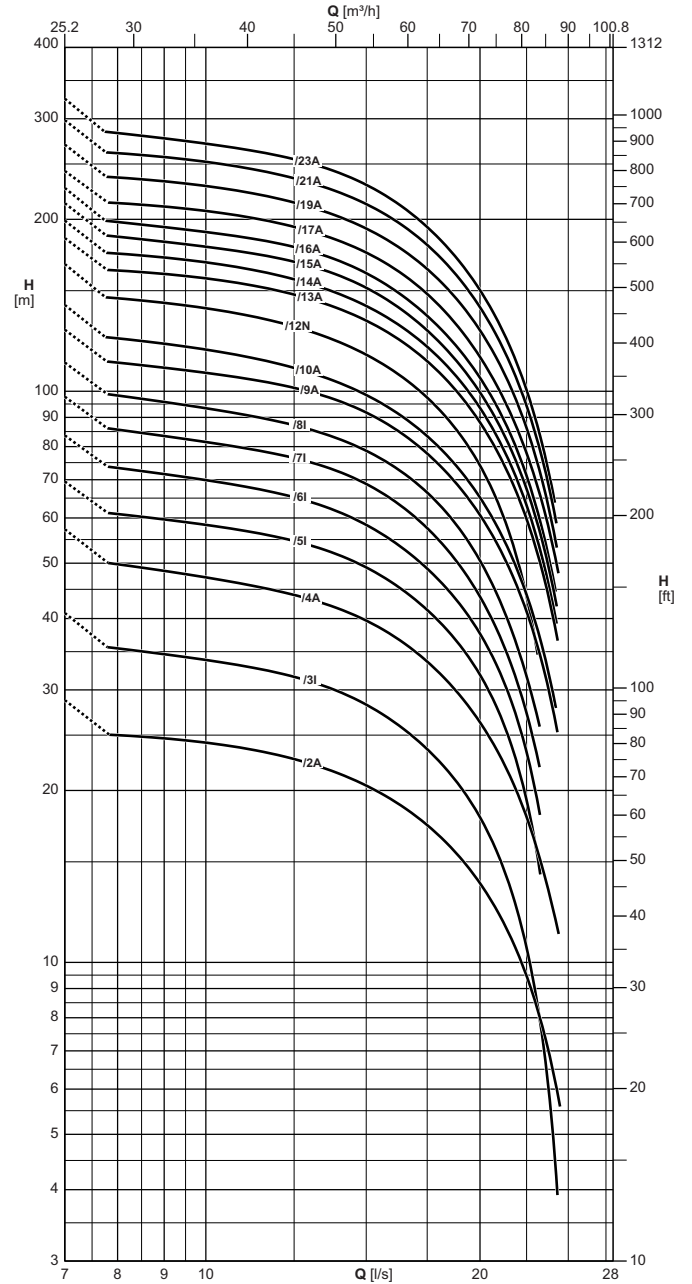

The hydraulic performance characteristics are guaranteed as conforming to standard UNI/ISO 9906 Grade 3B.  
Available with NPT thread.

Les caractéristiques hydrauliques de fonctionnement sont garanties conformes à la norme UNI/ISO 9906 Niveau 3B.  
Disponible avec filetage NPT.

Le caratteristiche di funzionamento vengono garantite secondo la norma: UNI/ISO 9906 Grado 3B.  
Disponibile con filettatura NPT.

Electric pump type Electropompe type Elettropompa tipo	Motor power Puis. moteur Potenza motore		Horizontal installation Installation horizontale Installazione orizzontale	Check valve $\varnothing$ Clapet de retenue $\varnothing$ Valvola di ritegno $\varnothing$	Capacity Debit Portata											
					[l/s]	0	8	8,5	9	9,5	10	12,5	15	17,5	20	22,5
	[l/min]	0			480	510	540	570	600	750	900	1050	1200	1350		
	[m <sup>3</sup> /h]	0			28,8	30,6	32,4	34,2	36	45	54	63	72	81		
[kW]	[HP]	Head Hauteur Prevalenza														
E6P55/2A+MAC65A	4	5,5	■	3" Gas	[m]	29	25	25	24,5	24,5	24,5	22,5	20,5	17,5	13,5	9,4
E6P55/3I+MAC67A	5,5	7,5	■	3" Gas	[m]	41	35,5	35	34,5	34	34	31,5	28,5	23,5	18	10,5
E6P55/4A+MAC610A	7,5	10	■	3" Gas	[m]	57	50	49	48,5	48	47	44	39,5	33,5	26	18
E6P55/5I+MAC612A	9,2	12,5	■	3" Gas	[m]	69	61	60	60	59	58	55	49	41,5	31,5	19,5
E6P55/6I+MAC615A	11	15	■	3" Gas	[m]	84	73	72	71	71	70	65	58	49	37,5	23,5
E6P55/7I+MAC617A	13	17,5	■	3" Gas	[m]	98	86	84	83	82	81	76	69	58	43,5	27
E6P55/8I+MAC620A	15	20	■	3" Gas	[m]	112	98	97	96	94	93	87	78	66	50	31,5
E6P55/9A+MAC625A	18,5	25	■	3" Gas	[m]	128	112	111	110	109	108	101	92	78	61	41
E6P55/10A+MAC625A	18,5	25	■	3" Gas	[m]	141	124	122	121	120	118	110	98	83	65	44
E6P55/12N+MAC630A	22	30	■	3" Gas	[m]	167	145	144	143	141	140	130	115	98	74	43
E6P55/13A+MAC635A	26	35	○	3" Gas	[m]	185	163	162	160	159	157	147	133	113	88	60
E6P55/14A+MAC635A	26	35	○	3" Gas	[m]	199	174	173	171	170	168	157	141	119	93	63
E6P55/15A+MAC640A	30	40	○	3" Gas	[m]	213	186	184	182	181	179	168	151	127	99	67
E6P55/16A+MAC640A	30	40	○	3" Gas	[m]	227	198	196	194	192	190	179	161	136	106	71
E6P55/17A+MAC650B	37	50	○	3" Gas	[m]	243	213	212	210	209	207	194	175	148	114	77
E6P55/19A+MAC650B	37	50	○	3" Gas	[m]	270	237	235	233	231	229	214	192	163	127	87
E6P55/21A+MAC660B	45	60	○	3" Gas	[m]	298	261	259	257	255	252	236	212	180	140	94
E6P55/23A+MAC660B	45	60	○	3" Gas	[m]	325	283	280	277	274	271	255	230	194	149	100
NPSH					[m]	-	4	4	4	4	4	4	4	4,2	5,2	7,1

M.E.I.  $\geq 0,40$

■ Without conical valve

□ On request

○ Please contact our sales organisation

For motor performances specification see page "motor features"

Temperature monitoring device for submersed electric motors 6" + 14": see page "Accessories"

■ Sans soupape du clapet.

□ Sur demande

○ Contacter notre service commercial.

Pour caractéristiques techniques moteurs voir page "Caractéristiques des moteurs"

Appareillage de contrôle de la température des moteurs électriques immergés 6" + 14": voir page "Accessories"

■ Senza clapet valvola di ritegno

□ Su richiesta

○ Interpellare la sede o la rete di vendita

Per caratteristiche motori vedere pagina "caratteristiche motori"

Apparecchiatura di controllo temperatura motori elettrici sommersi 6" + 14": vedere pagina accessori



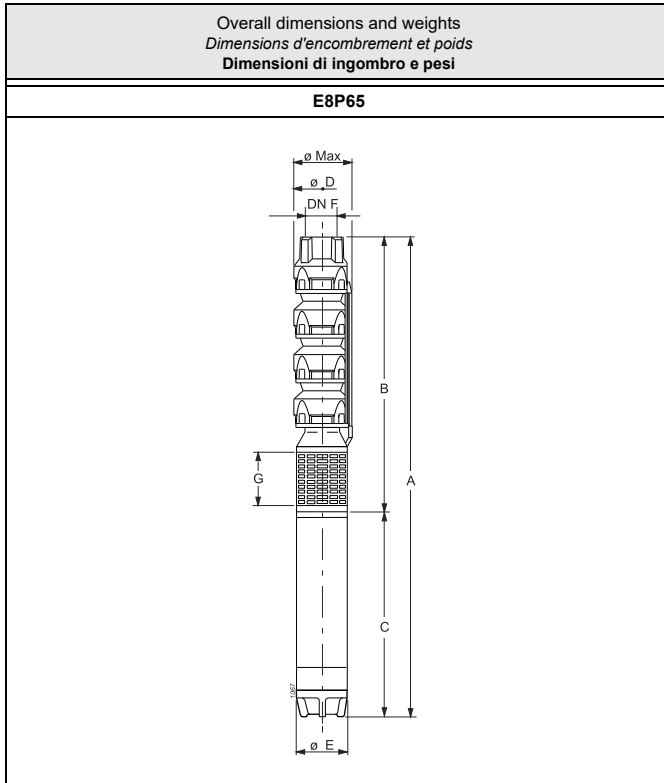

Type Type Tipo	ø max [mm]	Weight Poids Peso [kg]	A	B	C	D	E	G	F
			[mm]						
E8P65/1D+MAC65A	203	69,5	1130	560	570	192	143	165,5	G5
E8P65/1A+MAC67A	203	74,5	1175	560	615	192	143	165,5	G5
E8P65/2T+MAC610A	203	90	1365	695	670	192	143	165,5	G5
E8P65/2C+MAC612A	203	93	1395	695	700	192	143	165,5	G5
E8P65/2A+MAC615A	203	97,5	1410	695	715	192	143	165,5	G5
E8P65/3E+MAC615A	203	108	1545	830	715	192	143	165,5	G5
E8P65/3JD+MAC617A	203	112	1580	830	750	192	143	165,5	G5
E8P65/3K+MAC620A	203	115,8	1620	830	790	192	143	165,5	G5
E8P65/4JC+MAC625A	203	130,7	1795	965	830	192	143	165,5	G5
E8P65/4A+MAC630A	203	141,5	1885	965	920	192	143	165,5	G5
E8P65/5KC+MAC630A	203	151,5	2020	1100	920	192	143	165,5	G5
E8P65/5A+MAC635A	203	166,8	2155	1100	1055	192	143	165,5	G5
E8P65/6C+MAC640A	203	189,4	2400	1235	1165	192	143	165,5	G5
E8P65/6U+MAC640A	203	190,9	2400	1235	1165	192	143	165,5	G5
E8P65/6C+MAC840	203	230,5	2320,5	1260,5	1060	192	191	193,5	G5
E8P65/6U+MAC840	203	230,5	2320,5	1260,5	1060	192	191	193,5	G5
E8P65/7A+MAC650B	203	217	2652	1370	1282	192	143	165,5	G5
E8P65/7A+MAC850	203	253	2510,5	1395,5	1115	192	191	193,5	G5
E8P65/9T+MAC660B	203	241,8	2962	1640	1322	192	143	165,5	G5
E8P65/9T+MAC860	203	291,5	2860,5	1665,5	1195	192	191	193,5	G5
E8P65/10Z+MAC870	203	321,5	3090,5	1800,5	1290	192	191	193,5	G5
E8P65/11A+MAC880	203	350	3330,5	1935,5	1395	192	191	193,5	G5
E8P65/12A+MAC890	203	369,5	3500,5	2070,5	1430	192	191	193,5	G5
E8P65/14A+MAC8100	203	406,5	3840,5	2340,5	1500	192	191	193,5	G5
E8P65/16A+MAC8125	203	457,5	4295,5	2610,5	1685	192	191	193,5	G5
E8P65/17A+MAC8125	203	468	4430,5	2745,5	1685	192	191	193,5	G5

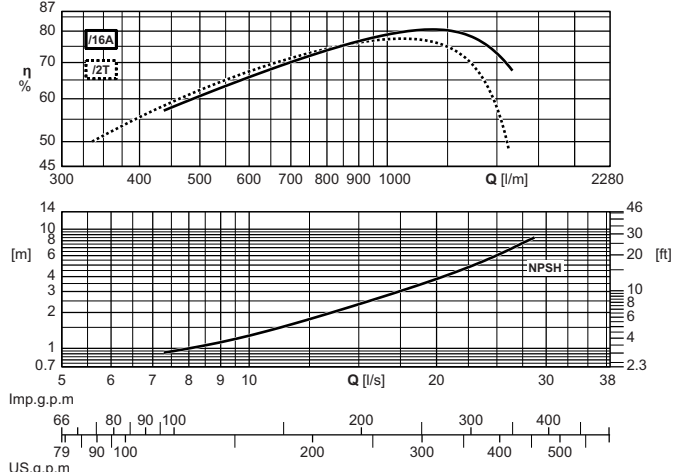
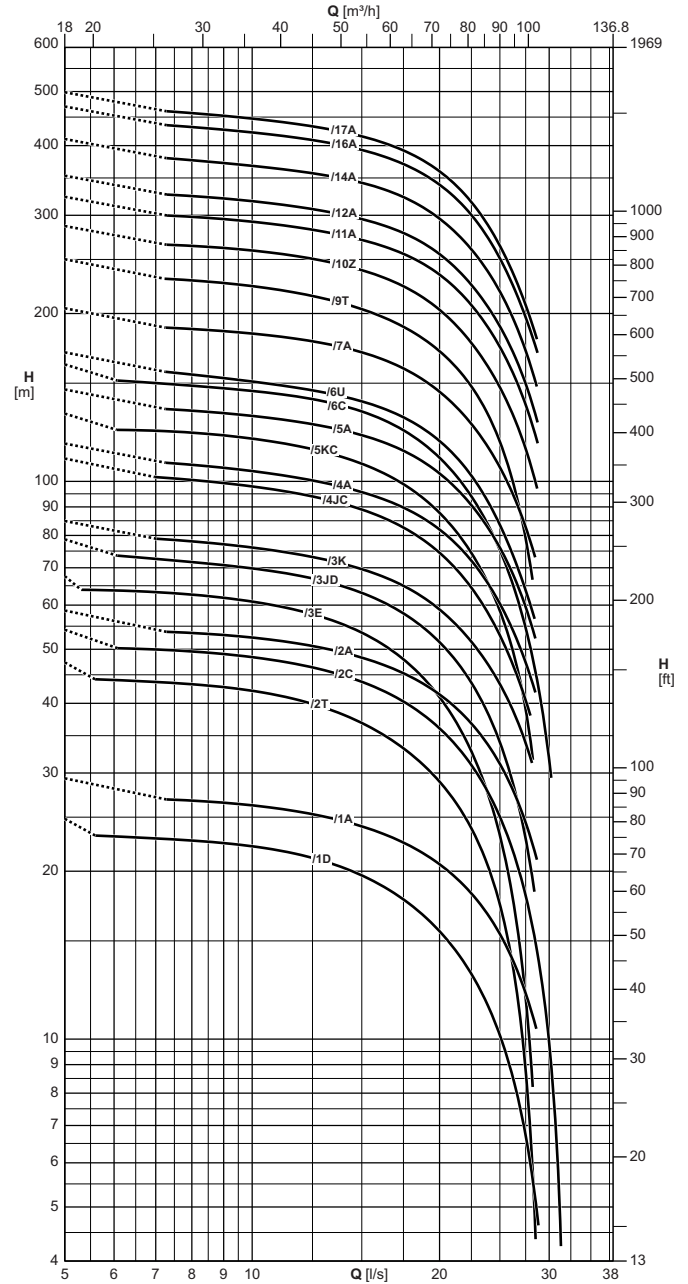

The hydraulic performance characteristics are guaranteed as conforming to standard UNI/ISO 9906 Grade 3B.

Available with NPT thread.

Three connection pipe kits flange are available, threaded at valve side and flanged at riser pipe side, counterflange and gasket: one with flange UNI/DIN, one with reduced flange and one with ANSI flanging.

Les caractéristiques hydrauliques de fonctionnement sont garanties conformes à la norme UNI/ISO 9906 Niveau 3B.

Disponible avec filetage NPT.

Trois kits embout fileté côté vanne et bride côté ascension, contre-bride, joint et boulonnerie sont disponibles : le premier à bridage UNI/DIN, le deuxième à bridage réduit et le troisième à bridage ANSI.

Le caratteristiche di funzionamento vengono garantite secondo la norma: UNI/ISO 9906 Grado 3B.

Disponibile con filettatura NPT.

Sono disponibili tre kit tronchetto filettato lato valvola e flangia sul lato di risalita, controflangia, guarnizione e bulloneria: uno a flangia UNI/DIN, uno a flangia ridotta e uno con flangiatura ANSI.

Electric pump type Electropompe type Elettropompa tipo	Motor power Puisse. moteur Potenza motore		Horizontal installation Installation horizontale Installazione orizzontale	Check valve $\varnothing$ Clapet de retenue $\varnothing$ Valvola di ritegno $\varnothing$	Capacity Debit Portata														
	[kW]	[HP]			[l/s]	0	6	7	8	9	10	12,5	15	17,5	20	22,5	25	27,5	30
					[l/min]	0	360	420	480	540	600	750	900	1050	1200	1350	1500	1650	1800
					[m <sup>3</sup> /h]	0	21,6	25,2	28,8	32,4	36	45	54	63	72	81	90	99	108
Head Hauteur Prevalenza																			
E8P65/1D+MAC65A	4	5,5	■	5" Gas	[m]	25	23	23	22,5	22,5	22	21	19,5	18	15,5	13	10	6,7	-
E8P65/1A+MAC67A	5,5	7,5	■	5" Gas	[m]	29,5	-	-	27	26,5	26	25,5	24	22,5	20,5	18	15,5	12	-
E8P65/2T+MAC610A	7,5	10	■	5" Gas	[m]	47,5	44	43,5	43,5	42,5	42	40	37	33,5	29	24	17,5	8,6	-
E8P65/2C+MAC612A	9,2	12,5	■	5" Gas	[m]	54	-	50	49,5	49	48,5	46,5	43,5	40	36	31	25	18	9,8
E8P65/2A+MAC615A	11	15	■	5" Gas	[m]	59	-	-	53	53	52	51	48,5	45,5	41,5	36,5	31	24,5	-
E8P65/3E+MAC615A	11	15	■	5" Gas	[m]	67	64	63	63	62	61	58	54	48	41	33	23	11,5	-
E8P65/3JD+MAC617A	13	17,5	■	5" Gas	[m]	79	-	72	71	71	70	67	63	58	51	43,5	34	22,5	-
E8P65/3K+MAC620A	15	20	■	5" Gas	[m]	85	-	79	78	77	76	73	69	65	59	52	43	34	-
E8P65/4JC+MAC625A	18,5	25	■	5" Gas	[m]	110	-	102	100	99	98	94	89	82	74	64	53	40,5	-
E8P65/4A+MAC630A	22	30	■	5" Gas	[m]	117	-	-	107	106	104	100	96	89	82	72	60	47,5	-
E8P65/5KC+MAC630A	22	30	■	5" Gas	[m]	132	-	123	122	121	119	114	107	99	88	74	58	38,5	-
E8P65/5A+MAC635A	26	35	■	5" Gas	[m]	146	-	-	134	132	131	126	121	113	103	90	76	60	-
E8P65/6C+MAC640A	30	40	○	5" Gas	[m]	162	-	150	148	147	145	140	133	123	110	94	75	55	31,5
E8P65/6U+MAC640A	30	40	○	5" Gas	[m]	170	-	-	155	153	151	145	139	130	118	102	84	64	-
E8P65/6C+MAC840	30	40	■	5" Gas	[m]	163	-	151	150	149	147	142	135	125	113	97	79	58	-
E8P65/6U+MAC840	30	40	■	5" Gas	[m]	171	-	-	157	156	154	149	141	132	120	104	87	67	-
E8P65/7A+MAC650B	37	50	○	5" Gas	[m]	204	-	-	187	186	184	178	170	159	144	127	106	83	-
E8P65/7A+MAC850	37	50	■	5" Gas	[m]	205	-	-	189	187	185	179	171	162	148	130	109	86	-
E8P65/9T+MAC660B	45	60	○	5" Gas	[m]	250	-	-	229	227	224	215	204	189	171	148	118	79	-
E8P65/9T+MAC860	45	60	■	5" Gas	[m]	253	-	-	233	231	229	221	210	197	178	155	126	89	-
E8P65/10Z+MAC870	51	70	■	5" Gas	[m]	287	-	-	264	262	259	250	239	223	203	177	147	115	-
E8P65/11A+MAC880	59	80	■	5" Gas	[m]	324	-	-	298	295	292	282	271	256	234	207	174	137	-
E8P65/12A+MAC890	66	90	■	5" Gas	[m]	353	-	-	325	321	318	308	295	279	255	225	190	149	-
E8P65/14A+MAC8100	75	100	○	5" Gas	[m]	411	-	-	377	372	368	357	343	323	296	260	219	171	-
E8P65/16A+MAC8125	92	125	○	5" Gas	[m]	470	-	-	432	427	422	409	393	371	340	301	251	197	-
E8P65/17A+MAC8125	92	125	○	5" Gas	[m]	499	-	-	457	452	447	433	416	392	360	316	265	206	-
NPSH					[m]	-	0,9	0,9	1	1,2	1,4	1,9	2,2	3	3,9	5	5,7	7,7	9,6

■ Without conical valve

□ On request

○ Please contact our sales organisation

For motor performances specification see page "motor features"

Temperature monitoring device for submersed electric motors 6" + 14": see page "Accessories"

■ Sans soupape du clapet.

□ Sur demande

○ Contacter notre service commercial.

Pour caracteristiques techniques moteurs voir page "Caracteristiques des moteurs"

Appareillage de contrôle de la température des moteurs électriques immergés 6" + 14": voir page "Accessories"

■ Senza clapet valvola di ritegno

□ Su richiesta

○ Interpellare la sede o la rete di vendita

Per caratteristiche motori vedere pagina "caratteristiche motori"

Apparecchiatura di controllo temperatura motori elettrici sommersi 6" + 14": vedere pagina accessori

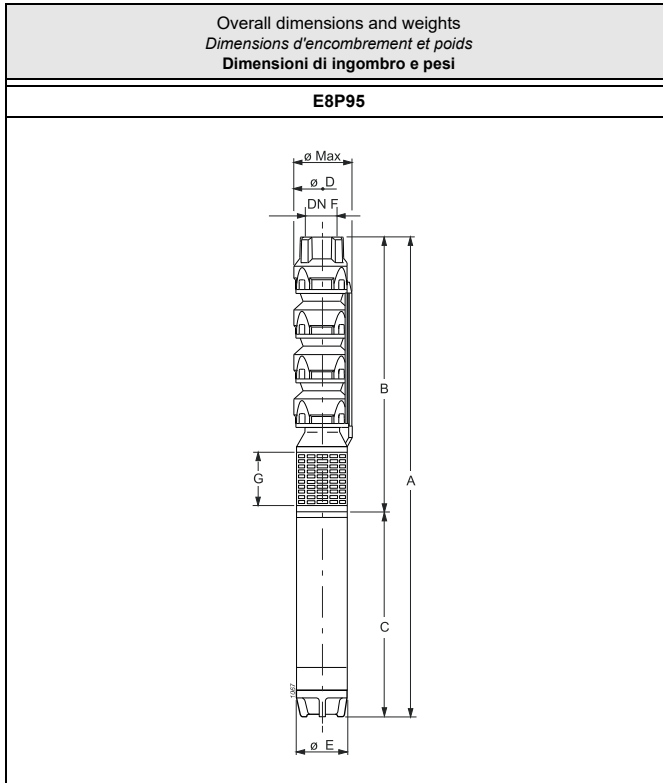

Type Type Tipo	Ø max [mm]	Weight Poids Peso [kg]	A	B	C	D	E	G	F
			[mm]						
E8P95/1C+MAC610A	203	80,5	1235	565	670	192	143	165,5	G5
E8P95/1A+MAC612A	203	83,5	1265	565	700	192	143	165,5	G5
E8P95/2F+MAC612A	203	94,5	1405	705	700	192	143	165,5	G5
E8P95/2DF+MAC615A	203	99	1420	705	715	192	143	165,5	G5
E8P95/2D+MAC617A	203	103	1455	705	750	192	143	165,5	G5
E8P95/2C+MAC620A	203	107	1495	705	790	192	143	165,5	G5
E8P95/2A+MAC625A	203	111	1535	705	830	192	143	165,5	G5
E8P95/3DJ+MAC625A	203	122	1675	845	830	192	143	165,5	G5
E8P95/3C+MAC630A	203	132,5	1765	845	920	192	143	165,5	G5
E8P95/3A+MAC635A	203	147,5	1900	845	1055	192	143	165,5	G5
E8P95/4D+MAC635A	203	158,5	2040	985	1055	192	143	165,5	G5
E8P95/4C+MAC640A	203	171	2150	985	1165	192	143	165,5	G5
E8P95/4A+MAC650B	203	188	2267	985	1282	192	143	165,5	G5
E8P95/4C+MAC840	203	212,5	2070,5	1010,5	1060	192	191	193,5	G5
E8P95/4A+MAC850	203	224,5	2125,5	1010,5	1115	192	191	193,5	G5
E8P95/5KC+MAC650B	203	199	2407	1125	1282	192	143	165,5	G5
E8P95/5A+MAC660B	203	203,5	2447	1125	1322	192	143	165,5	G5
E8P95/5KC+MAC850	203	235,5	2265,5	1150,5	1115	192	191	193,5	G5
E8P95/5A+MAC860	203	252,5	2345,5	1150,5	1195	192	191	193,5	G5
E8P95/6QC+MAC660B	203	214,5	2447	1125	1322	192	143	165,5	G5
E8P95/6QC+MAC860	203	263,5	2485,5	1290,5	1195	192	191	193,5	G5
E8P95/7ZC+MAC870	203	294,5	2720,5	1430,5	1290	192	191	193,5	G5
E8P95/7Z+MAC880	203	312,5	2825,5	1430,5	1395	192	191	193,5	G5
E8P95/8Z+MAC890	203	332,5	3000,5	1570,5	1430	192	191	193,5	G5
E8P95/10XC+MAC8100	203	370,5	3350,5	1850,5	1500	192	191	193,5	G5
E8P95/10A+MAC8125	203	400,5	3535,5	1850,5	1685	192	191	193,5	G5
E8P95/12C+MAC8125	203	422,5	3815,5	2130,5	1685	192	191	193,5	G5

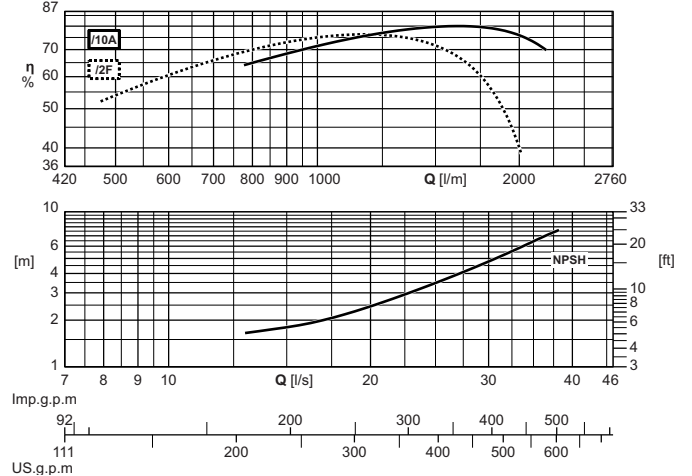
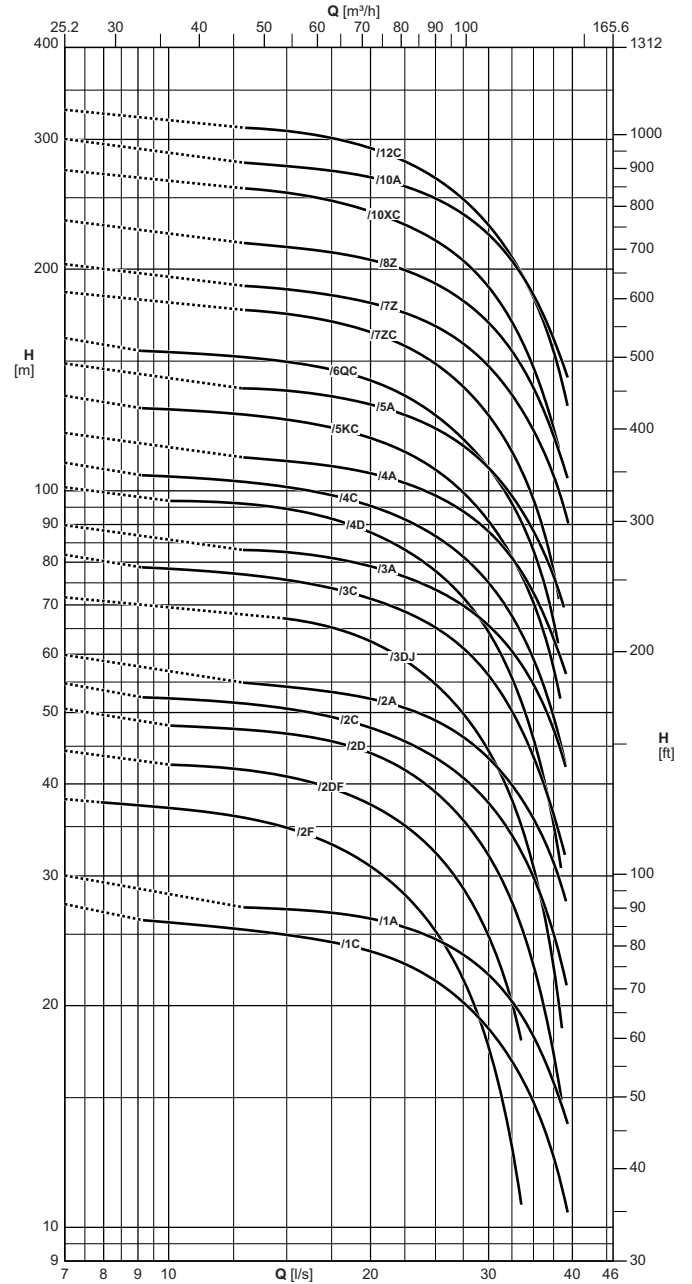

The hydraulic performance characteristics are guaranteed as conforming to standard UNI/ISO 9906 Grade 3B.

Available with NPT thread.

Three connection pipe kits flange are available, threaded at valve side and flanged at riser pipe side, counterflange and gasket: one with flange UNI/DIN, one with reduced flange and one with ANSI flanging.

Les caractéristiques hydrauliques de fonctionnement sont garanties conformes à la norme UNI/ISO 9906 Niveau 3B.

Disponible avec filetage NPT.

Trois kits embout fileté côté vanne et bride côté ascension, contre-bride, joint et boulonnerie sont disponibles : le premier à bridage UNI/DIN, le deuxième à bridage réduit et le troisième à bridage ANSI.

Le caratteristiche di funzionamento vengono garantite secondo la norma: UNI/ISO 9906 Grado 3B.

Disponibile con filettatura NPT.

Sono disponibili tre kit tronchetto filettato lato valvola e flangia sul lato di risalita, controflangia, guarnizione e bulloneria: uno a flangia UNI/DIN, uno a flangia ridotta e uno con flangiatura ANSI.

Electric pump type Electropompe type Elettropompa tipo	Motor power Puis. moteur Potenza motore		Horizontal installation Installation horizontale Installazione orizzontale	Check valve $\varnothing$ Clapet de retenue $\varnothing$ Valvola di ritegno $\varnothing$	Capacity Debit Portata																
	[kW]	[HP]			[l/s]	0	8	9	10	12,5	15	17,5	20	22,5	25	27,5	30	32,5	35	37,5	
					[l/min]	0	480	540	600	750	900	1050	1200	1350	1500	1650	1800	1950	2100	2250	
					[m <sup>3</sup> /h]	0	28,8	32,4	36	45	54	63	72	81	90	99	108	117	126	135	
		Head Hauteur Prevalenza																			
		[m]	27,5	-	-	26	25,5	25	24,5	23,5	23	21,5	20	18,5	17	15	12,5				
E8P95/1C+MAC610A	7,5	10	■	5" Gas	[m]	27,5	-	-	26	25,5	25	24,5	23,5	23	21,5	20	18,5	17	15	12,5	
E8P95/1A+MAC612A	9,2	12,5	■	5" Gas	[m]	30	-	-	-	-	27	26,5	26	25,5	24,5	23,5	22	20,5	18	15,5	
E8P95/2F+MAC612A	9,2	12,5	■	5" Gas	[m]	38	37,5	37,5	37	36	35	33	31	28,5	25,5	21,5	17,5	13	-	-	
E8P95/2DF+MAC615A	11	15	■	5" Gas	[m]	44,5	-	-	-	42	41	39,5	37,5	35	32,5	29	25	20	-	-	
E8P95/2D+MAC617A	13	17,5	■	5" Gas	[m]	51	-	-	-	47,5	47	45,5	44	42	39	35,5	32	27,5	22,5	17	
E8P95/2C+MAC620A	15	20	■	5" Gas	[m]	55	-	-	52	52	51	49,5	47,5	45,5	43,5	40,5	37,5	34	30	25	
E8P95/2A+MAC625A	18,5	25	■	5" Gas	[m]	60	-	-	-	-	54	53	52	51	48,5	46,5	43,5	40	36	31,5	
E8P95/3DJ+MAC625A	18,5	25	■	5" Gas	[m]	72	-	-	-	-	67	65	62	59	55	49,5	44,5	38	30,5	22,5	
E8P95/3C+MAC630A	22	30	■	5" Gas	[m]	82	-	-	78	77	76	74	71	68	65	61	56	50	43,5	36,5	
E8P95/3A+MAC635A	26	35	■	5" Gas	[m]	90	-	-	-	-	82	81	79	76	73	70	65	61	55	47,5	
E8P95/4D+MAC635A	26	35	■	5" Gas	[m]	101	-	-	-	96	94	91	88	83	78	71	64	56	46	35,5	
E8P95/4C+MAC640A	30	40	○	5" Gas	[m]	109	-	-	104	103	101	98	95	91	87	81	75	67	59	49	
E8P95/4A+MAC650B	37	50	○	5" Gas	[m]	120	-	-	-	-	110	108	105	102	98	94	88	81	73	63	
E8P95/4C+MAC840	30	40	■	5" Gas	[m]	110	-	-	-	-	102	99	96	93	88	82	76	68	60	50	
E8P95/4A+MAC850	37	50	■	5" Gas	[m]	120	-	-	-	-	111	109	107	104	100	95	89	83	74	65	
E8P95/5KC+MAC650B	37	50	○	5" Gas	[m]	134	-	-	129	127	125	122	118	113	107	99	91	81	70	57	
E8P95/5A+MAC660B	45	60	○	5" Gas	[m]	149	-	-	-	-	137	134	131	127	121	115	107	98	88	76	
E8P95/5KC+MAC850	37	50	■	5" Gas	[m]	135	-	-	-	-	126	123	119	114	108	101	93	84	72	59	
E8P95/5A+MAC860	45	60	■	5" Gas	[m]	150	-	-	-	-	138	136	133	130	125	119	112	103	93	81	
E8P95/6QC+MAC660B	45	60	○	5" Gas	[m]	161	-	-	154	152	150	146	141	134	127	117	107	96	83	66	
E8P95/6QC+MAC860	45	60	■	5" Gas	[m]	163	-	-	-	-	150	147	143	138	131	122	112	101	87	72	
E8P95/7ZC+MAC870	51	70	■	5" Gas	[m]	186	-	-	-	-	174	170	164	157	148	138	126	113	97	78	
E8P95/7Z+MAC880	59	80	■	5" Gas	[m]	203	-	-	-	-	188	184	180	174	167	158	147	135	121	105	
E8P95/8Z+MAC890	66	90	■	5" Gas	[m]	233	-	-	-	-	214	211	206	199	191	181	169	155	138	119	
E8P95/10XC+MAC8100	75	100	○	5" Gas	[m]	272	-	-	-	-	254	247	239	230	218	205	189	170	146	122	
E8P95/10A+MAC8125	92	125	○	5" Gas	[m]	300	-	-	-	-	276	272	266	259	249	237	222	205	184	161	
E8P95/12C+MAC8125	92	125	○	5" Gas	[m]	329	-	-	-	-	308	301	292	280	266	249	229	207	183	155	
NPSH					[m]	-	1,3	1,5	1,5	1,8	1,9	2,1	2,5	2,9	3,5	4,1	4,8	5,6	6,4	7,6	

■ Without conical valve

○ On request

○ Please contact our sales organisation

For motor performances specification see page "motor features"

Temperature monitoring device for submersed electric motors 6" + 14": see page "Accessories"

■ Sans soupape du clapet.

○ Sur demande

○ Contacter notre service commercial.

Pour caractéristiques techniques moteurs voir page "Caractéristiques des moteurs"

Appareillage de contrôle de la température des moteurs électriques immergés 6" + 14": voir page "Accessories"

■ Senza clapet valvola di ritegno

○ Su richiesta

○ Interpellare la sede o la rete di vendita

Per caratteristiche motori vedere pagina "caratteristiche motori"

Apparecchiatura di controllo temperatura motori elettrici sommersi 6" + 14": vedere pagina accessori

Operating data  
Caracteristiques de fonctionnement  
Caratteristiche di funzionamento

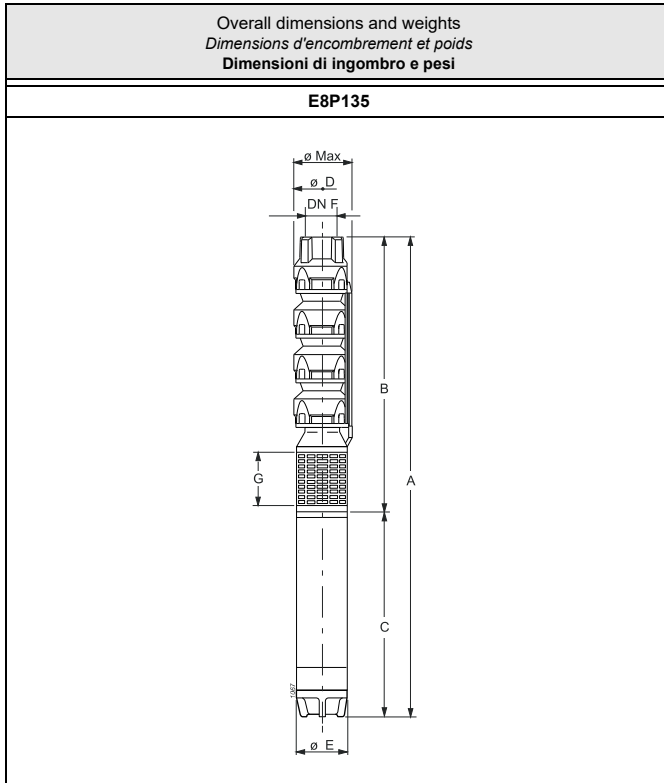

Type Type Tipo	Ø max [mm]	Weight Poids Peso [kg]	A	B	C	D	E	G	F
			[mm]						
E8P135/1F+MAC67A	203	75,5	1180	565	615	192	143	165,5	G5"
E8P135/1D+MAC610A	203	80,5	1235	565	670	192	143	165,5	G5"
E8P135/1B+MAC612A	203	83,5	1265	565	700	192	143	165,5	G5"
E8P135/2G+MAC612A	203	94,5	1405	705	700	192	143	165,5	G5"
E8P135/2F+MAC615A	203	99	1420	705	715	192	143	165,5	G5"
E8P135/2E+MAC617A	203	103	1455	705	750	192	143	165,5	G5"
E8P135/2D+MAC620A	203	107	1495	705	790	192	143	165,5	G5"
E8P135/2B+MAC625A	203	111	1535	705	830	192	143	165,5	G5"
E8P135/3E+MAC625A	203	122	1675	845	830	192	143	165,5	G5"
E8P135/3D+MAC630A	203	132,5	1765	845	920	192	143	165,5	G5"
E8P135/3B+MAC635A	203	147,5	1900	845	1055	192	143	165,5	G5"
E8P135/4D+MAC640A	203	171	2150	985	1165	192	143	165,5	G5"
E8P135/4C+MAC650B	203	188	2267	985	1282	192	143	165,5	G5"
E8P135/4D+MAC840	203	215	2070,5	1010,5	1060	192	191	193,5	G5"
E8P135/4C+MAC850	203	227	2125,5	1010,5	1115	192	191	193,5	G5"
E8P135/5D+MAC650B	203	199	2407	1125	1282	192	143	165,5	G5"
E8P135/5B+MAC660B	203	206,5	2447	1125	1322	192	143	165,5	G5"
E8P135/5D+MAC850	203	238	2265,5	1150,5	1115	192	191	193,5	G5"
E8P135/5B+MAC860	203	255	2345,5	1150,5	1195	192	191	193,5	G5"
E8P135/6C+MAC870	203	286	2580,5	1290,5	1290	192	191	193,5	G5"
E8P135/7C+MAC880	203	315	2825,5	1430,5	1395	192	191	193,5	G5"
E8P135/7A+MAC890	203	324	2860,5	1430,5	1430	192	191	193,5	G5"
E8P135/8C+MAC890	203	335	3000,5	1570,5	1430	192	191	193,5	G5"
E8P135/8A+MAC8100	203	351	3070,5	1570,5	1500	192	191	193,5	G5"
E8P135/9C+MAC8100	203	362	3210,5	1710,5	1500	192	191	193,5	G5"
E8P135/10C+MAC8125	203	403	3535,5	1850,5	1685	192	191	193,5	G5"
E8P135/11C+MAC8125	203	414	3675,5	1990,5	1685	192	191	193,5	G5"

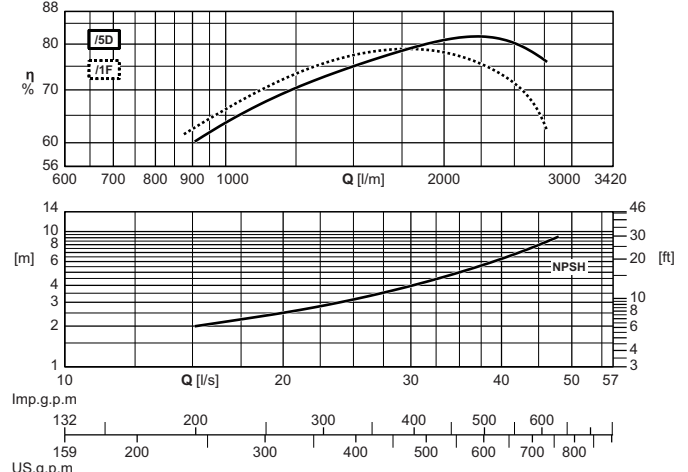
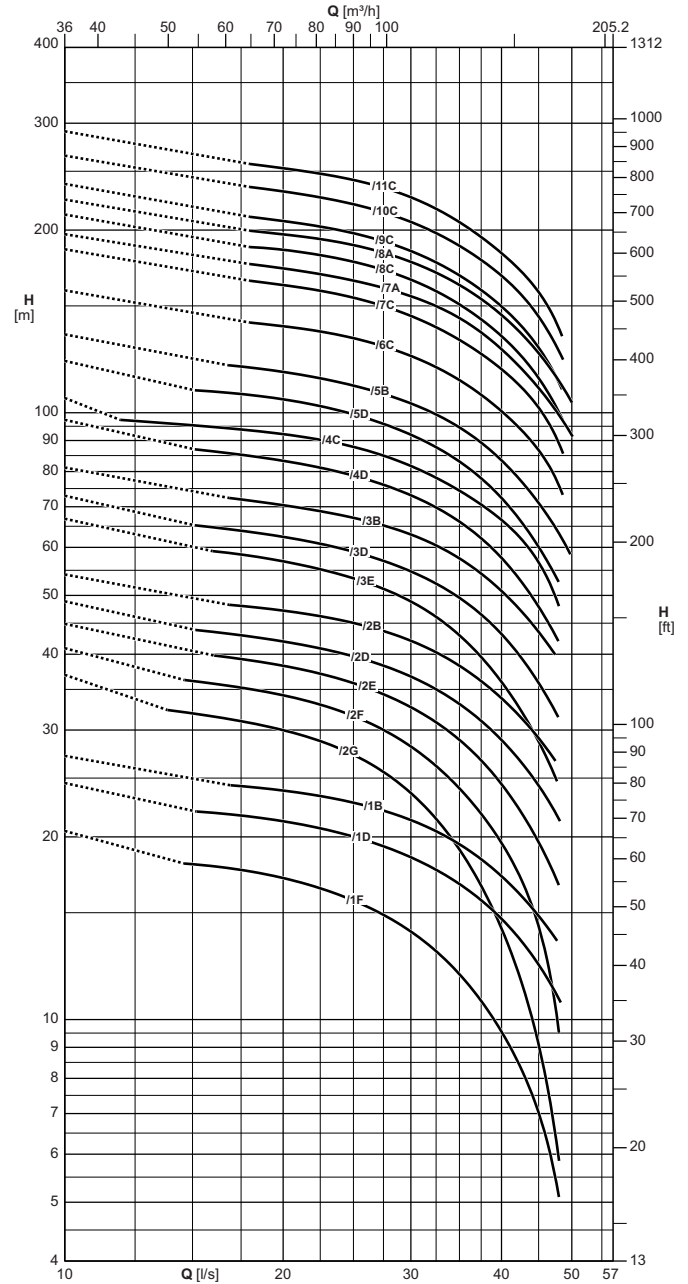

The hydraulic performance characteristics are guaranteed as conforming to standard UNI/ISO 9906 Grade 3B.

Available with NPT thread.

Three connection pipe kits flange are available, threaded at valve side and flanged at riser pipe side, counterflange and gasket: one with flange UNI/DIN, one with reduced flange and one with ANSI flanging.

Les caractéristiques hydrauliques de fonctionnement sont garanties conformes à la norme UNI/ISO 9906 Niveau 3B.

Disponible avec filetage NPT.

Trois kits embout fileté côté vanne et bride côté ascension, contre-bride, joint et boulonnerie sont disponibles : le premier à bridage UNI/DIN, le deuxième à bridage réduit et le troisième à bridage ANSI.

Le caratteristiche di funzionamento vengono garantite secondo la norma: UNI/ISO 9906 Grado 3B.

Disponibile con filettatura NPT.

Sono disponibili tre kit tronchetto filettato lato valvola e flangia sul lato di risalita, controflangia, guarnizione e bulloneria: uno a flangia UNI/DIN, uno a flangia ridotta e uno con flangiatura ANSI.

Electric pump type Electropompe type Elettropompa tipo	Motor power Puisse. moteur Potenza motore		Horizontal installation Installation horizontale Installazione orizzontale	Check valve Ø Clapet de retenue Ø Valvola di ritegno Ø	Capacity Debit Portata																
	[kW]	[HP]			[l/s]	0	15	17,5	20	22,5	25	27,5	30	32,5	35	37,5	40	42,5	45	47,5	50
					[l/min]	0	900	1050	1200	1350	1500	1650	1800	1950	2100	2250	2400	2550	2700	2850	3000
					[m³/h]	0	54	63	72	81	90	99	108	117	126	135	144	153	162	171	180
		Head Hauteur Prevalenza																			
		[m]	20,5	18	17,5	17	16,5	15,5	15	14	13	12	11	9,6	8,3	7	5,4	-			
E8P135/1F+MAC67A	5,5	7,5	■	5 <sup>mm</sup> Gas	[m]	20,5	18	17,5	17	16,5	15,5	15	14	13	12	11	9,6	8,3	7	5,4	-
E8P135/1D+MAC610A	7,5	10	■	5 <sup>mm</sup> Gas	[m]	24,5	-	21,5	21	20,5	20	19,5	18,5	17,5	16,5	15,5	14,5	13,5	12,5	11	-
E8P135/1B+MAC612A	9,2	12,5	■	5 <sup>mm</sup> Gas	[m]	27	-	24	24	23,5	23	22	21,5	20,5	19,5	18,5	17	16	15	13,5	-
E8P135/2G+MAC612A	9,2	12,5	■	5 <sup>mm</sup> Gas	[m]	37	32	31	30	28,5	27,5	25,5	23,5	21,5	19	16,5	14	11,5	9,1	6,4	-
E8P135/2F+MAC615A	11	15	■	5 <sup>mm</sup> Gas	[m]	41	36	35	34	33	31,5	30	28	26	24	22	19,5	17	14	10,5	-
E8P135/2E+MAC617A	13	17,5	■	5 <sup>mm</sup> Gas	[m]	45	-	39,5	38,5	37	36	34,5	32,5	31	29	26,5	24,5	22	19,5	17	-
E8P135/2D+MAC620A	15	20	■	5 <sup>mm</sup> Gas	[m]	49	-	43	42	41	39,5	38,5	37	35	33	31	29	26,5	24,5	22	-
E8P135/2B+MAC625A	18,5	25	■	5 <sup>mm</sup> Gas	[m]	54	-	48	47	46	45	43,5	42	40,5	38,5	36	34	31,5	29	26,5	-
E8P135/3E+MAC625A	18,5	25	■	5 <sup>mm</sup> Gas	[m]	67	-	58	57	55	53	51	49	46	43	39,5	36	32,5	28,5	25	-
E8P135/3D+MAC630A	22	30	■	5 <sup>mm</sup> Gas	[m]	73	-	64	62	61	59	57	55	52	49,5	46,5	43	39,5	36	32	-
E8P135/3B+MAC635A	26	35	■	5 <sup>mm</sup> Gas	[m]	81	-	72	70	69	67	65	63	60	58	54	51	47	43,5	-	-
E8P135/4D+MAC640A	30	40	○	5 <sup>mm</sup> Gas	[m]	97	-	85	83	81	79	76	73	70	66	62	58	53	48	43	-
E8P135/4C+MAC650B	37	50	○	5 <sup>mm</sup> Gas	[m]	106	95	94	92	90	88	85	82	78	74	70	66	62	57	49,5	-
E8P135/4D+MAC840	30	40	■	5 <sup>mm</sup> Gas	[m]	98	-	-	84	82	80	77	74	70	67	63	59	54	49	44	-
E8P135/4C+MAC850	37	50	■	5 <sup>mm</sup> Gas	[m]	106	-	-	93	91	89	86	83	79	76	72	67	63	58	52	-
E8P135/5D+MAC650B	37	50	○	5 <sup>mm</sup> Gas	[m]	122	-	107	105	102	99	96	92	88	83	78	72	66	60	54	-
E8P135/5B+MAC660B	45	60	○	5 <sup>mm</sup> Gas	[m]	134	-	119	117	114	111	107	103	99	94	89	83	77	71	64	-
E8P135/5D+MAC850	37	50	■	5 <sup>mm</sup> Gas	[m]	122	-	-	106	103	100	96	93	88	84	79	74	68	62	55	-
E8P135/5B+MAC860	45	60	■	5 <sup>mm</sup> Gas	[m]	136	-	121	119	116	114	111	107	103	98	92	86	80	74	68	-
E8P135/6C+MAC870	51	70	■	5 <sup>mm</sup> Gas	[m]	159	-	-	139	136	132	129	124	119	113	107	100	94	87	78	-
E8P135/7C+MAC880	59	80	■	5 <sup>mm</sup> Gas	[m]	186	-	-	162	159	155	150	144	138	132	125	118	110	102	91	-
E8P135/7A+MAC890	66	90	■	5 <sup>mm</sup> Gas	[m]	197	-	-	173	169	165	160	155	150	143	135	127	119	110	101	92
E8P135/8C+MAC890	66	90	○	5 <sup>mm</sup> Gas	[m]	212	-	-	185	182	177	172	166	159	151	142	134	124	114	102	-
E8P135/8A+MAC8100	75	100	○	5 <sup>mm</sup> Gas	[m]	224	-	-	197	193	189	183	177	170	162	154	145	135	125	115	104
E8P135/9C+MAC8100	75	100	○	5 <sup>mm</sup> Gas	[m]	238	-	-	207	202	197	191	184	177	168	159	150	139	128	115	-
E8P135/10C+MAC8125	92	125	○	5 <sup>mm</sup> Gas	[m]	265	-	-	231	226	221	214	206	198	188	179	168	157	144	129	-
E8P135/11C+MAC8125	92	125	○	5 <sup>mm</sup> Gas	[m]	291	-	-	253	248	242	235	226	216	206	195	183	171	158	141	-
NPSH					[m]	-	2	2,2	2,5	2,8	3,1	3,5	4	4,5	5	5,6	6,2	7	7,8	9	10

■ Without conical valve

□ On request

○ Please contact our sales organisation

For motor performances specification see page "motor features"

Temperature monitoring device for submersed electric motors 6" + 14": see page "Accessories"

■ Sans soupape du clapet.

□ Sur demande

○ Contacter notre service commercial.

Pour caractéristiques techniques moteurs voir page "Caractéristiques des moteurs"

Appareillage de contrôle de la température des moteurs électriques immergés 6" + 14": voir page "Accessories"

■ Senza clapet valvola di ritegno

□ Su richiesta

○ Interpellare la sede o la rete di vendita

Per caratteristiche motori vedere pagina "caratteristiche motori"

Apparecchiatura di controllo temperatura motori elettrici sommersi 6" + 14": vedere pagina accessori

Operating data  
Caracteristiques de fonctionnement  
Caratteristiche di funzionamento

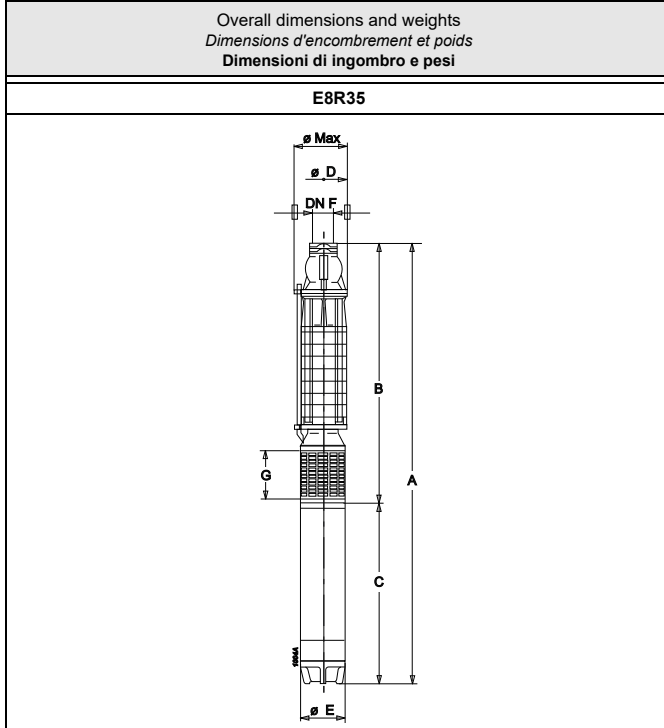

Type Type Tipo	Ø max [mm]	Weight Poids Peso [kg]	A	B	C	D	E	G	F
E8R35/11A+MAC630A	196	153,5	2118	1198	920	188	143	210	G3
E8R35U/12A+MAC630A	196	167	2176	1256	920	188	143	210	G3
E8R35/13A+MAC635A	196	177,3	2369	1314	1055	188	143	210	G3
E8R35U/14A+MAC635A	196	192,3	2427	1372	1055	188	143	210	G3
E8R35/15A+MAC640A	196	198,9	2595	1430	1165	188	143	210	G3
E8R35/15A+MAC840	197.5*	240	2515,5	1455,5	1060	188	191	210	G3
E8R35U/16A+MAC640A	196	215,4	2653	1488	1165	188	143	210	G3
E8R35U/16A+MAC840	197.5*	251,3	2631,5	1571,5	1060	188	191	210	G3
E8R35/17A+MAC650B	196	225	2828	1546	1282	188	143	210	G3
E8R35/17A+MAC850	197.5*	261	2686,5	1571,5	1115	188	191	210	G3
E8RB35U/18A+MAC650B	196	249	2988	1706	1282	188	143	210	G3
E8RB35U/18A+MAC850	197.5*	285	2846,5	1731,5	1115	188	191	210	G3
E8R35/19A+MAC650B	196	234	2944	1662	1282	188	143	210	G3
E8R35/19A+MAC850	197.5*	270	2802,5	1687,5	1115	188	191	210	G3
E8RB35U/20A+MAC650B	196	259,5	3104	1822	1282	188	143	210	G3
E8RB35U/20A+MAC850	197.5*	295,5	2962,5	1847,5	1115	188	191	210	G3
E8R35/23A+MAC660B	196	256,3	3216	1894	1322	188	143	210	G3
E8R35/23A+MAC860	197.5*	305	3114,5	1919,5	1195	188	191	210	G3
E8RB35U/24A+MAC660B	196	284,8	3376	2054	1322	188	143	210	G3
E8RB35U/24A+MAC860	197.5*	333,5	3274,5	2079,5	1195	188	191	210	G3
E8RB35/27A+MAC870	197.5*	349	3543,5	2253,5	1290	188	191	210	G3
E8RB35U/27A+MAC870	197.5*	369,3	3543,5	2253,5	1290	188	191	210	G3
E8RB35/31A+MAC880	197.5*	385	3880,5	2485,5	1395	188	191	210	G3
E8RB35U/31A+MAC880	197.5*	408,3	3880,5	2485,5	1395	188	191	210	G3
E8RB35/35A+MAC890	197.5*	412	4147,5	2717,5	1430	188	191	210	G3

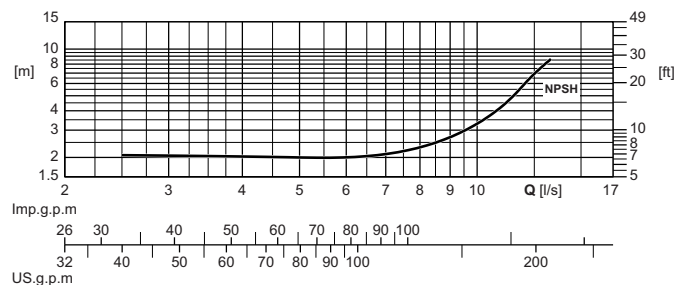
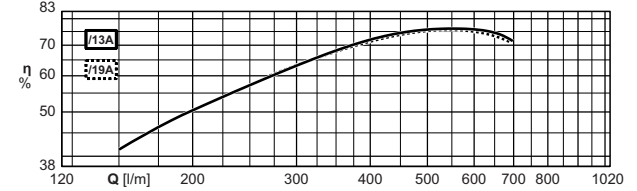
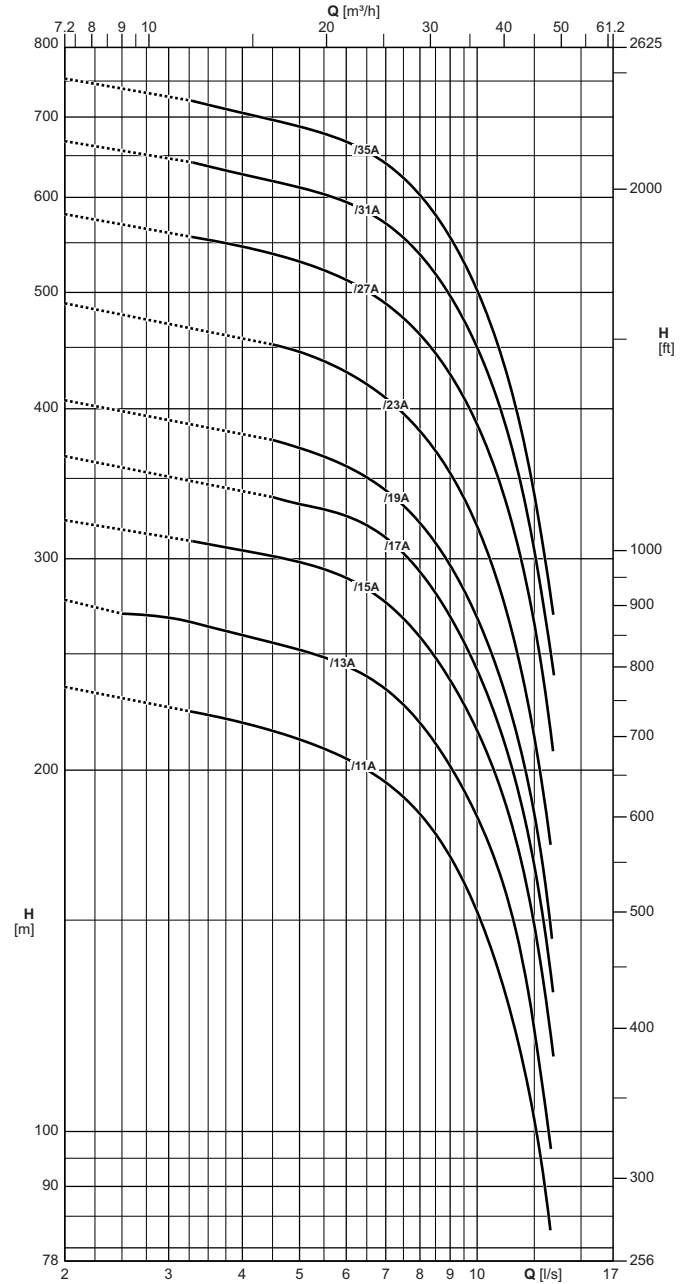

(\*) Ø max for direct starting 400 V / please check the Ø max with other voltages

The hydraulic performance characteristics are guaranteed as conforming to standard UNI/ISO 9906 Grade 3B.

Available with NPT thread.

Three connection pipe kits flange are available, threaded at valve side and flanged at riser pipe side, counterflange and gasket: one with flange UNI/DIN, one with reduced flange and one with ANSI flanging.

(\*) Ø max pour démarrage direct 400 V / vérifier le Ø max pour tensions différentes

Les caractéristiques hydrauliques de fonctionnement sont garanties conformes à la norme UNI/ISO 9906 Niveau 3B.

Disponible avec filetage NPT.

Trois kits embout fileté côté vanne et bride côté ascension, contre-bride, joint et boulonnerie sont disponibles : le premier à bridage UNI/DIN, le deuxième à bridage réduit et le troisième à bridage ANSI.

(\*) Ø max per avviamento diretto 400 V / verificare Ø max per tensioni diverse

Le caratteristiche di funzionamento vengono garantite secondo la norma: UNI/ISO 9906 Grado 3B.

Disponibile con filettatura NPT.

Sono disponibili tre kit tronchetto filettato lato valvola e flangia sul lato di risalita, controflangia, guarnizione e bulloneria: uno a flangia UNI/DIN, uno a flangia ridotta e uno con flangiatura ANSI.

Operating data  
 Caracteristiques de fonctionnement  
 Caratteristiche di funzionamento

Electric pump type Electropompe type Elettropompa tipo	Motor power Puisse. moteur Potenza motore		Horizontal installation Installation horizontale Installazione orizzontale	Check valve $\varnothing$ Clapet de retenue $\varnothing$ Valvola di ritegno $\varnothing$	Capacity Debit Portata												
	[kW]	[HP]			[l/s]	0	3	4	5	6	7	8	9	10	11	12	13
					[l/min]	0	180	240	300	360	420	480	540	600	660	720	780
					[m <sup>3</sup> /h]	0	10,8	14,4	18	21,6	25,2	28,8	32,4	36	39,6	43,2	46,8
		Head Hauteur Prevalenza															
E8R35/11A+MAC630A	22	30	■	3" Gas	[m]	234	-	219	212	204	196	183	169	152	134	113	90
E8R35U/12A+MAC630A	22	30	■	3" Gas	[m]	256	-	238	228	218	206	192	174	154	134	-	-
E8R35/13A+MAC635A	26	35	■	3" Gas	[m]	277	268	259	252	244	234	219	201	182	163	136	106
E8R35U/14A+MAC635A	26	35	■	3" Gas	[m]	301	-	280	271	259	246	228	209	185	161	132	-
E8R35/15A+MAC640A	30	40	○	3" Gas	[m]	323	-	305	298	289	275	258	237	216	192	165	131
E8R35/15A+MAC840	30	40	■	3" Gas	[m]	323	-	305	298	289	275	258	237	216	192	165	131
E8R35U/16A+MAC640A	30	40	○	3" Gas	[m]	342	-	-	306	294	276	257	234	209	179	-	-
E8R35U/16A+MAC840	30	40	■	3" Gas	[m]	342	-	319	309	296	279	260	235	210	180	149	-
E8R35/17A+MAC650B	37	50	○	3" Gas	[m]	365	-	-	333	325	313	293	268	243	214	182	149
E8R35/17A+MAC850	37	50	■	3" Gas	[m]	368	-	349	340	329	315	298	275	251	221	189	153
E8RB35U/18A+MAC650B	37	50	○	3" Gas	[m]	386	-	360	348	333	317	293	268	238	206	169	-
E8RB35U/18A+MAC850	37	50	■	3" Gas	[m]	389	-	365	351	336	318	298	272	245	211	176	-
E8R35/19A+MAC650B	37	50	○	3" Gas	[m]	407	-	-	371	358	341	321	296	267	238	203	162
E8R35/19A+MAC850	37	50	■	3" Gas	[m]	410	-	387	378	366	350	328	304	275	244	209	170
E8RB35U/20A+MAC650B	37	50	○	3" Gas	[m]	427	-	398	382	363	342	320	293	264	227	-	-
E8RB35U/20A+MAC850	37	50	■	3" Gas	[m]	430	-	402	389	372	354	330	303	271	235	189	-
E8R35/23A+MAC660B	45	60	○	3" Gas	[m]	490	-	-	447	429	408	382	353	320	280	235	190
E8R35/23A+MAC860	45	60	■	3" Gas	[m]	496	-	469	456	442	423	397	368	333	295	252	206
E8RB35U/24A+MAC660B	45	60	○	3" Gas	[m]	510	-	474	453	432	406	376	347	310	265	-	-
E8RB35U/24A+MAC860	45	60	■	3" Gas	[m]	516	-	482	466	446	424	393	361	320	279	227	-
E8RB35/27A+MAC870	51	70	■	3" Gas	[m]	581	-	546	530	513	489	461	428	387	344	291	235
E8RB35U/27A+MAC870	51	70	■	3" Gas	[m]	581	-	544	523	503	477	441	402	361	318	255	-
E8RB35/31A+MAC880	59	80	○	3" Gas	[m]	668	-	627	611	595	572	537	497	449	397	338	274
E8RB35U/31A+MAC880	59	80	○	3" Gas	[m]	669	-	625	605	581	551	512	468	421	362	300	-
E8RB35/35A+MAC890	66	90	○	3" Gas	[m]	754	-	706	687	668	639	602	556	503	442	378	301
NPSH					[m]	-	2,1	2,1	1,9	2	2,3	2,4	2,8	3,3	4,2	5,4	8,8

■ Without conical valve

○ On request

○ Please contact our sales organisation

For motor performances specification see page "motor features"

Temperature monitoring device for submersed electric motors 6" + 14": see page "Accessories"

With metallic impellers, performances are different

■ Sans soupape du clapet.

○ Sur demande

○ Contacter notre service commercial.

Pour caracteristiques techniques moteurs voir page "Caracteristiques des moteurs"

Appareillage de contrôle de la température des moteurs électriques immergés 6" + 14": voir page "Accessories"

Avec métalliques roues, les caracteristiques sont différentes

■ Senza clapet valvola di ritegno

○ Su richiesta

○ Interpellare la sede o la rete di vendita

Per caratteristiche motori vedere pagina "caratteristiche motori"

Apparecchiatura di controllo temperatura motori elettrici sommersi 6" + 14": vedere pagina accessori

Nella versione con giranti metalliche le prestazioni sono diverse.



Operating data  
Caractéristiques de fonctionnement  
Caratteristiche di funzionamento

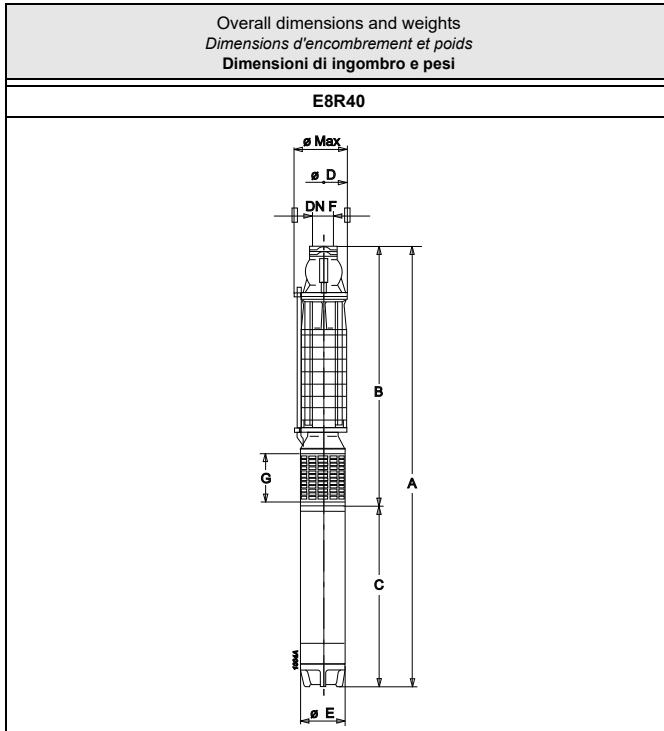

Type Type Tipo	Ø max [mm]	Weight Poids Peso [kg]	A	B	C	D	E	G	F
E8R40/6A+MAC630A	196	131	1888	968	920	188	143	210	G3
E8R40U/7A+MAC630A	196	142,5	1958	1038	920	188	143	210	G3
E8R40/7A+MAC635A	196	150,3	2093	1038	1055	188	143	210	G3
E8R40U/8A+MAC635A	196	162,8	2163	1108	1055	188	143	210	G3
E8R40/8A+MAC635A	196	154,8	2163	1108	1055	188	143	210	G3
E8R40U/9A+MAC640A	196	180,9	2343	1178	1165	188	143	210	G3
E8R40/9A+MAC640A	196	171,9	2343	1178	1165	188	143	210	G3
E8R40/9A+MAC840	197,5*	213	2275,5	1215,5	1060	188	191	210	G3
E8R40U/9A+MAC840	197,5*	222	2275,5	1215,5	1060	188	191	210	G3
E8R40/11A+MAC650B	196	200,5	2600	1318	1282	188	143	210	G3
E8R40U/11A+MAC650B	196	209	2600	1318	1282	188	143	210	G3
E8R40/11A+MAC850	197,5*	234	2470,5	1355,5	1115	188	191	210	G3
E8R40U/11A+MAC850	197,5*	245	2470,5	1355,5	1115	188	191	210	G3
E8R40/13A+MAC660B	196	209,3	2780	1458	1322	188	143	210	G3
E8R40U/13A+MAC660B	196	224,3	2780	1458	1322	188	143	210	G3
E8R40/13A+MAC860	197,5*	260	2690,5	1495,5	1195	188	191	210	G3
E8R40U/13A+MAC860	197,5*	273	2690,5	1495,5	1195	188	191	210	G3
E8R40U/14A+MAC660B	196	229,8	2850	1528	1322	188	143	210	G3
E8R40U/14A+MAC860	197,5*	278,5	2690,5	1495,5	1195	188	191	210	G3
E8R40/15A+MAC870	197,5*	289	2855,5	1565,5	1290	188	191	210	G3
E8RB40U/16A+MAC870	197,5*	315,5	3097,5	1807,5	1290	188	191	210	G3
E8R40/17A+MAC880	197,5*	316	3100,5	1705,5	1395	188	191	210	G3
E8RB40U/18A+MAC880	197,5*	344,5	3342,5	1947,5	1395	188	191	210	G3
E8R40/19A+MAC890	197,5*	334	3275,5	1845,5	1430	188	191	210	G3
E8RB40U/21A+MAC890	197,5*	370	3587,5	2157,5	1430	188	191	210	G3
E8RB40/21A+MAC8100	197,5*	365	3657,5	2157,5	1500	188	191	210	G3
E8RB40/23A+MAC8100	197,5*	374	3797,5	2297,5	1500	188	191	210	G3
E8RB40U/23A+MAC8100	197,5*	397	3797,5	2297,5	1500	188	191	210	G3
E8RB40/25A+MAC8125	197,5*	413	4122,5	2437,5	1685	188	191	210	G3
E8RB40/28A+MAC8125	197,5*	426,5	4332,5	2647,5	1685	188	191	210	G3
E8RB40/30A+MAC8150	197,5*	483,5	4547,5	2787,5	1760	188	191	210	G3

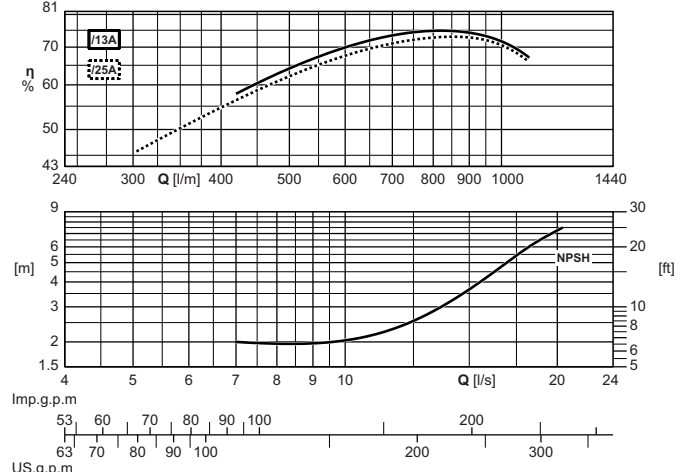
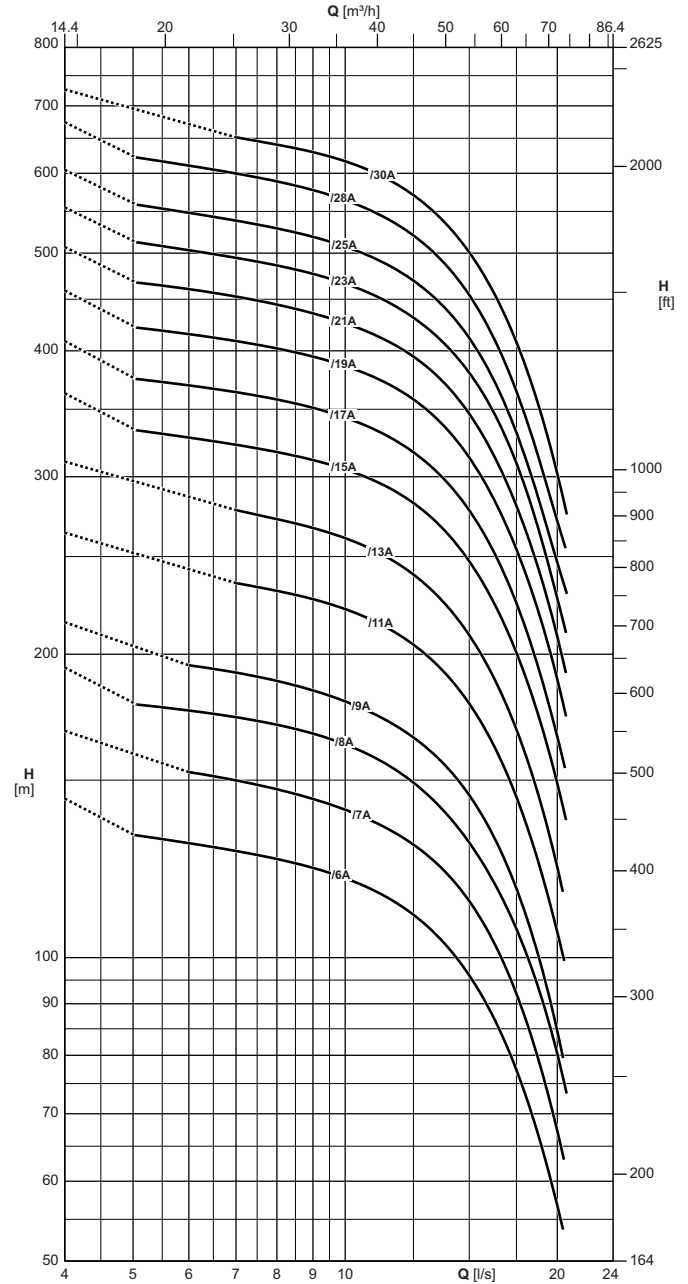

(\* ) Ø max for direct starting 400 V / please check the Ø max with other voltages

The hydraulic performance characteristics are guaranteed as conforming to standard UNI/ISO 9906 Grade 3B.  
Available with NPT thread.

Three connection pipe kits flange are available, threaded at valve side and flanged at riser pipe side, counterflange and gasket: one with flange UNI/DIN, one with reduced flange and one with ANSI flanging.

(\* ) Ø max pour démarrage direct 400 V / vérifier le Ø max pour tensions différentes

Les caractéristiques hydrauliques de fonctionnement sont garanties conformes à la norme UNI/ISO 9906 Niveau 3B.  
Disponible avec filetage NPT.

Trois kits embout fileté côté vanne et bride côté ascension, contre-bride, joint et boulonnerie sont disponibles : le premier à bridage UNI/DIN, le deuxième à bridage réduit et le troisième à bridage ANSI.

(\* ) Ø max per avviamento diretto 400 V / verificare Ø max per tensioni diverse

Le caratteristiche di funzionamento vengono garantite secondo la norma: UNI/ISO 9906 Grado 3B.  
Disponibile con filettatura NPT.

Sono disponibili tre kit tronchetto filettato lato valvola e flangia sul lato di risalita, controflangia, guarnizione e bulloneria: uno a flangia UNI/DIN, uno a flangia ridotta e uno con flangiatura ANSI.

Operating data  
Caracteristiques de fonctionnement  
Caratteristiche di funzionamento

Electric pump type Electropompe type Elettropompa tipo	Motor power Puiss. moteur Potenza motore		Horizontal installation Installation horizontale Installazione orizzontale	Check valve Ø Clapet de retenue Ø Valvola di ritegno Ø	Capacity Debit Portata																	
	[kW]	[HP]			[l/s]	0	5	6	7	8	9	10	11	12	13	14	15	16	17	18	19	20
					[l/min]	0	300	360	420	480	540	600	660	720	780	840	900	960	1020	1080	1140	1200
					[m³/h]	0	18	21,6	25,2	28,8	32,4	36	39,6	43,2	46,8	50,4	54	57,6	61,2	64,8	68,4	72
Head Hauteur Prevalenza																						
E8R40/6A+MAC630A	22	30	■	3" Gas	[m]	144	132	130	127	125	123	120	116	112	108	102	96	89	81	74	65	57
E8R40U/7A+MAC630A	22	30	■	3" Gas	[m]	161	-	148	147	145	142	138	134	129	123	116	108	99	88	75	60	-
E8R40/7A+MAC635A	26	35	■	3" Gas	[m]	168	-	153	150	147	143	140	136	132	126	121	114	106	96	87	77	67
E8R40U/8A+MAC635A	26	35	■	3" Gas	[m]	184	-	169	167	165	161	157	152	146	139	132	122	112	99	84	67	-
E8R40/8A+MAC635A	26	35	■	3" Gas	[m]	194	-	176	173	170	167	163	158	152	145	138	130	121	111	102	91	80
E8R40U/9A+MAC640A	30	40	○	3" Gas	[m]	205	-	-	186	184	180	175	169	163	155	146	135	123	109	92	72	-
E8R40/9A+MAC640A	30	40	○	3" Gas	[m]	215	-	195	192	188	184	179	174	169	162	154	145	134	123	111	98	84
E8R40/9A+MAC840	30	40	■	3" Gas	[m]	217	-	198	194	191	186	182	177	172	165	157	147	136	125	113	101	88
E8R40U/9A+MAC840	30	40	■	3" Gas	[m]	205	189	189	187	184	180	175	169	163	155	146	135	124	109	92	72	-
E8R40/11A+MAC650B	37	50	○	3" Gas	[m]	264	-	-	235	231	227	221	216	209	200	190	179	166	151	136	120	107
E8R40U/11A+MAC650B	37	50	○	3" Gas	[m]	251	-	-	227	225	220	214	207	199	190	178	166	151	134	114	92	-
E8R40/11A+MAC850	37	50	■	3" Gas	[m]	267	246	241	237	233	229	224	218	211	203	193	181	168	154	140	125	110
E8R40U/11A+MAC850	37	50	■	3" Gas	[m]	253	-	233	231	228	223	217	211	203	194	184	171	157	139	119	92	-
E8R40/13A+MAC660B	45	60	○	3" Gas	[m]	311	-	-	278	272	267	261	253	244	234	222	208	193	176	160	142	123
E8R40U/13A+MAC660B	45	60	○	3" Gas	[m]	296	-	-	268	264	258	251	242	233	222	208	194	176	155	131	104	-
E8R40/13A+MAC860	45	60	■	3" Gas	[m]	315	-	286	281	276	271	265	258	250	240	229	216	201	184	168	148	129
E8R40U/13A+MAC860	45	60	■	3" Gas	[m]	299	-	276	274	270	264	257	249	240	229	217	202	186	164	139	105	-
E8R40/14A+MAC660B	45	60	○	3" Gas	[m]	318	-	-	288	283	276	268	259	249	236	222	206	187	165	139	110	-
E8R40U/14A+MAC860	45	60	■	3" Gas	[m]	322	-	297	294	289	283	275	266	257	245	232	216	198	175	149	115	-
E8R40/15A+MAC870	51	70	■	3" Gas	[m]	363	-	328	323	317	311	305	297	288	276	262	248	230	210	190	169	149
E8RB40U/16A+MAC870	51	70	■	3" Gas	[m]	368	-	337	334	330	323	316	306	295	281	266	246	225	199	169	135	-
E8R40/17A+MAC880	59	80	■	3" Gas	[m]	409	375	370	364	358	351	343	334	324	311	295	277	257	236	214	189	166
E8RB40U/18A+MAC880	59	80	■	3" Gas	[m]	415	-	382	378	373	366	357	346	333	318	301	279	256	227	194	155	-
E8R40/19A+MAC890	66	90	○	3" Gas	[m]	459	-	416	409	402	394	387	377	365	350	333	314	291	267	241	214	190
E8RB40U/21A+MAC890	66	90	○	3" Gas	[m]	482	-	443	439	432	423	413	400	386	368	348	323	296	261	222	175	-
E8RB40/21A+MAC8100	75	100	○	3" Gas	[m]	507	-	461	453	444	435	426	415	402	386	367	347	322	295	266	237	209
E8RB40/23A+MAC8100	75	100	○	3" Gas	[m]	555	-	504	495	486	476	467	454	439	422	402	381	355	325	292	258	228
E8RB40U/23A+MAC8100	75	100	○	3" Gas	[m]	528	-	486	481	474	465	453	439	423	403	382	354	325	288	245	190	-
E8RB40/25A+MAC8125	92	125	○	3" Gas	[m]	605	-	548	538	529	519	508	494	478	460	438	412	381	349	315	279	246
E8RB40/28A+MAC8125	92	125	○	3" Gas	[m]	674	622	611	600	589	577	564	550	531	509	483	454	422	385	345	306	270
E8RB40/30A+MAC8150	110	150	○	3" Gas	[m]	727	-	-	651	640	630	617	601	581	558	532	501	465	426	389	345	301
NPSH					[m]	-	2	2	2	2	2	2	2,2	2,4	2,8	3,3	3,8	4,4	4,7	5,7	6,5	6,8

■ Without conical valve

□ On request

○ Please contact our sales organisation

For motor performances specification see page "motor features"

Temperature monitoring device for submersed electric motors 6" + 14": see page "Accessories"

With metallic impellers, performances are different

■ Sans soupape du clapet.

□ Sur demande

○ Contacter notre service commercial.

Pour caractéristiques techniques moteurs voir page "Caractéristiques des moteurs"

Appareillage de contrôle de la température des moteurs électriques immergés 6" + 14": voir page "Accessories"

Avec métalliques roues, les caractéristiques sont différentes

■ Senza clapet valvola di ritegno

□ Su richiesta

○ Interpellare la sede o la rete di vendita

Per caratteristiche motori vedere pagina "caratteristiche motori"

Apparecchiatura di controllo temperatura motori elettrici sommersi 6" + 14": vedere pagina accessori

Nella versione con giranti metalliche le prestazioni sono diverse.

Operating data  
 Caracteristiques de fonctionnement  
 Caratteristiche di funzionamento

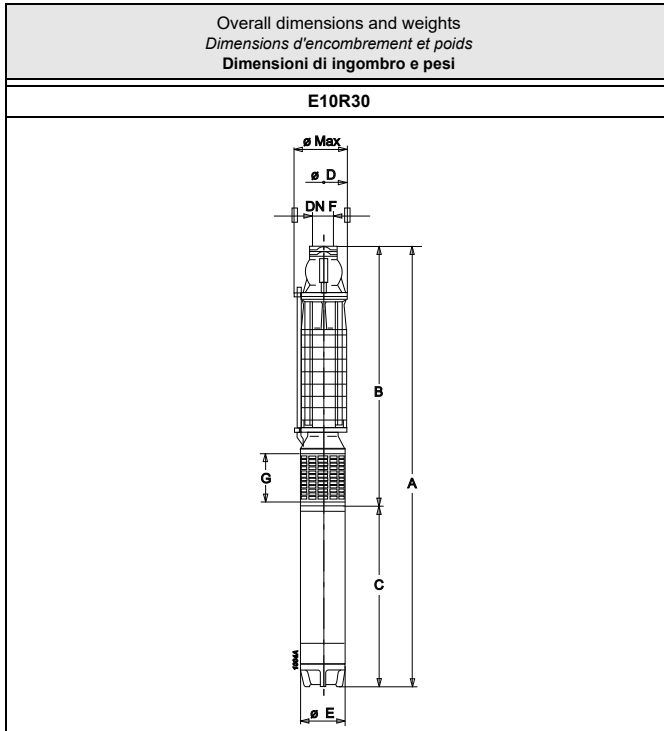

Type Type Tipo	Ø max [mm]	Weight Poids Peso [kg]	A	B	C	D	E	G	F
			[mm]						
E10R30/5A+MAC840	244	241	2018,5	958,5	1060	215	191	160	G4
E10R30/6A+MAC850	244	263	2145,5	1030,5	1115	215	191	160	G4
E10R30/8M+MAC860	244	299	2369,5	1174,5	1195	215	191	160	G4
E10R30/9K+MAC870	244	329	2536,5	1246,5	1290	215	191	160	G4
E10R30/10A+MAC880	244	357	2713,5	1318,5	1395	215	191	160	G4
E10R30/11A+MAC890	244	376	2820,5	1390,5	1430	215	191	160	G4
E10R30/13M+MAC8100	244	412	3034,5	1534,5	1500	215	191	160	G4
E10R30/13M+MAC10100A	251	477	2940,5	1534,5	1406	215	242	160	G4
E10R30/14A+MAC8125	244	452	3291,5	1606,5	1685	215	191	160	G4
E10R30/14A+MAC10125A	251	525	3142,5	1606,5	1536	215	242	160	G4
E10R30/15A+MAC8125	244	462	3363,5	1678,5	1685	215	191	160	G4
E10R30/15A+MAC10125A	251	535	3214,5	1678,5	1536	215	242	160	G4
E10RB30/16A+MAC8150	244	500	3598,5	1838,5	1760	215	191	160	G4
E10RB30/16A+MAC10150A	251	590	3479,5	1838,5	1641	215	242	160	G4
E10RB30/17A+MAC8150	244	510	3670,5	1910,5	1760	215	191	160	G4
E10RB30/17A+MAC10150A	251	600	3551,5	1910,5	1641	215	242	160	G4
E10RB30/18A+MAC8150	244	520	3742,5	1982,5	1760	215	191	160	G4
E10RB30/18A+MAC10150A	251	610	3623,5	1982,5	1641	215	242	160	G4
E10RB30/19A+MAC10180A	251	655	3820,5	2054,5	1766	215	242	160	G4
E10RB30/20A+MAC10180A	251	665	3892,5	2126,5	1766	215	242	160	G4

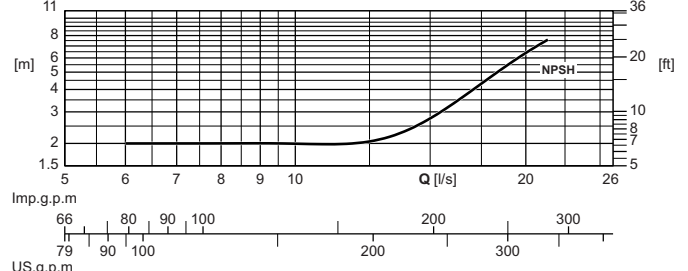
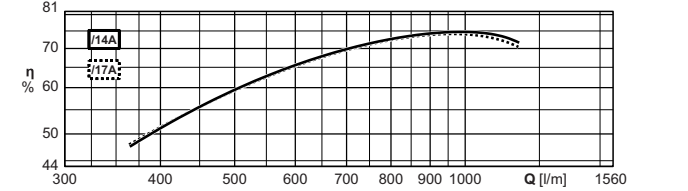
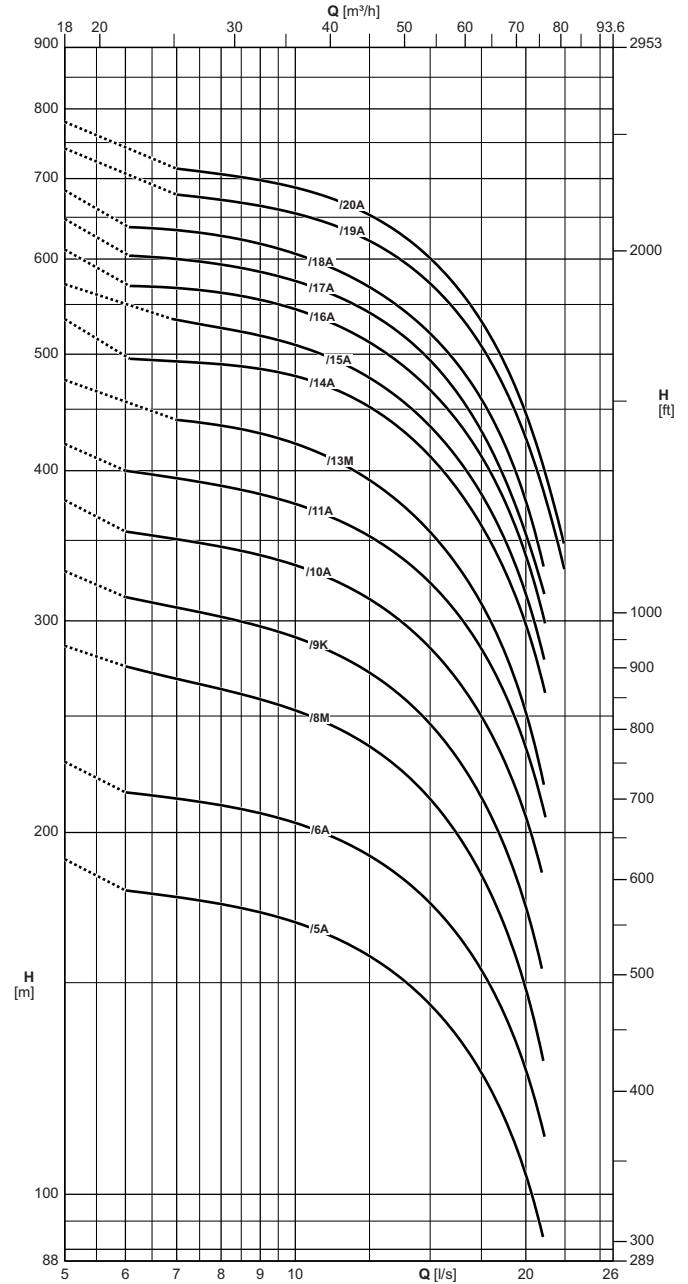

The hydraulic performance characteristics are guaranteed as conforming to standard UNI/ISO 9906 Grade 3B. Available with NPT thread.

Les caractéristiques hydrauliques de fonctionnement sont garanties conformes à la norme UNI/ISO 9906 Niveau 3B. Disponible avec filetage NPT.

Le caratteristiche di funzionamento vengono garantite secondo la norma: UNI/ISO 9906 Grado 3B. Disponibile con filettatura NPT.

Operating data  
Caracteristiques de fonctionnement  
Caratteristiche di funzionamento

Electric pump type Electropompe type Elettropompa tipo	Motor power Puis. moteur Potenza motore		Horizontal installation Installation horizontale Installazione orizzontale	Check valve $\varnothing$ Clapet de retenue $\varnothing$ Valvola di ritegno $\varnothing$	Capacity Debit Portata														
					[l/s]	0	6	6,5	7	7,5	8	8,5	9	9,5	10	12,5	15	17,5	20
	[l/min]	0			360	390	420	450	480	510	540	570	600	750	900	1050	1200		
	[m <sup>3</sup> /h]	0			21,6	23,4	25,2	27	28,8	30,6	32,4	34,2	36	45	54	63	72		
[kW]	[HP]	Head Hauteur Prevalenza																	
E10R30/5A+MAC840	30	40	■	4" Gas	[m]	190	179	178	177	175	174	173	172	170	168	157	144	126	104
E10R30/6A+MAC850	37	50	■	4" Gas	[m]	229	216	215	213	212	211	209	207	206	204	191	175	154	127
E10R30/8M+MAC860	45	60	■	4" Gas	[m]	286	275	272	269	266	263	261	258	255	253	235	213	184	148
E10R30/9K+MAC870	51	70	■	4" Gas	[m]	330	314	311	308	305	302	300	297	294	290	271	246	213	173
E10R30/10A+MAC880	59	80	■	4" Gas	[m]	378	356	353	351	348	346	343	340	337	333	313	285	249	206
E10R30/11A+MAC890	66	90	■	4" Gas	[m]	421	400	397	394	391	389	386	382	379	375	353	322	284	235
E10R30/13M+MAC8100	75	100	○	4" Gas	[m]	476	-	-	441	438	436	433	429	425	421	392	356	310	251
E10R30/13M+MAC10100A	75	100	■	4" Gas	[m]	479	460	456	452	448	444	440	436	431	427	400	364	318	260
E10R30/14A+MAC8125	92	125	○	4" Gas	[m]	535	-	495	493	492	490	489	486	483	480	451	410	360	298
E10R30/14A+MAC10125A	92	125	■	4" Gas	[m]	541	510	507	504	502	498	495	491	487	483	456	418	369	310
E10R30/15A+MAC8125	92	125	○	4" Gas	[m]	572	-	-	534	529	526	522	518	513	509	477	435	382	315
E10R30/15A+MAC10125A	92	125	■	4" Gas	[m]	579	551	547	543	540	536	532	528	523	519	489	448	396	332
E10RB30/16A+MAC8150	110	150	○	4" Gas	[m]	611	-	569	568	565	563	559	555	551	545	511	466	411	340
E10RB30/16A+MAC10150A	110	150	○	4" Gas	[m]	620	591	587	584	580	576	572	568	564	559	527	485	429	361
E10RB30/17A+MAC8150	110	150	○	4" Gas	[m]	648	-	602	600	597	594	589	585	580	575	541	494	432	356
E10RB30/17A+MAC10150A	110	150	○	4" Gas	[m]	659	628	623	619	615	611	606	602	598	592	559	512	455	378
E10RB30/18A+MAC8150	110	150	○	4" Gas	[m]	684	-	636	634	631	627	622	617	612	606	569	521	458	377
E10RB30/18A+MAC10150A	110	150	○	4" Gas	[m]	696	645	645	645	644	641	639	635	631	626	591	542	481	401
E10RB30/19A+MAC10180A	132	180	○	4" Gas	[m]	742	-	-	679	675	672	668	664	659	655	621	572	509	425
E10RB30/20A+MAC10180A	132	180	○	4" Gas	[m]	780	-	-	714	710	706	702	697	693	687	653	600	534	447
NPSH					[m]	-	2	2	2,1	2	2	2	2,1	2	2	2	2,8	4,3	6,4

■ Without conical valve

□ On request

○ Please contact our sales organisation

For motor performances specification see page "motor features"

■ Sans soupape du clapet.

□ Sur demande

○ Contacter notre service commercial.

Pour caractéristiques techniques moteurs voir page "Caractéristiques des moteurs"

■ Senza clapet valvola di ritegno

□ Su richiesta

○ Interpellare la sede o la rete di vendita

Per caratteristiche motori vedere pagina "caratteristiche motori"

Temperature monitoring device for submersed electric motors 6" + 14": see page "Accessories"

Appareillage de contrôle de la température des moteurs électriques immergés 6" + 14": voir page "Accessories"

Apparecchiatura di controllo temperatura motori elettrici sommersi 6" + 14": vedere pagina accessori

Operating data  
 Caracteristiques de fonctionnement  
 Caratteristiche di funzionamento

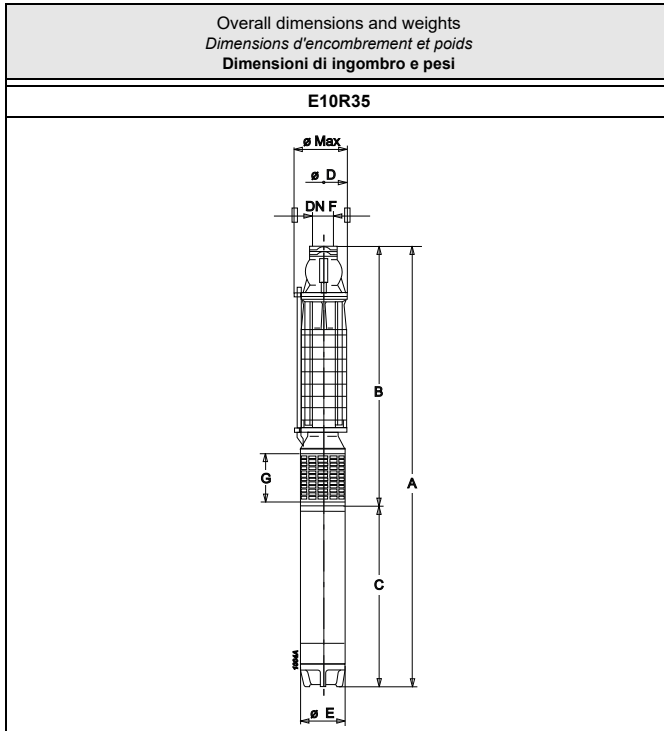

Type Type Tipo	Ø max	Weight Poids Peso	A	B	C	D	E	G	F
	[mm]								
E10R35/5A+MAC850	244	250	2073,5	958,5	1115	215	191	160	G4
E10R35/6A+MAC850	244	260	2145,5	1030,5	1115	215	191	160	G4
E10R35/7A+MAC860	244	287	2297,5	1102,5	1195	215	191	160	G4
E10R35/8A+MAC870	244	317	2464,5	1174,5	1290	215	191	160	G4
E10R35/9A+MAC880	244	345	2641,5	1246,5	1395	215	191	160	G4
E10R35/10A+MAC890	244	364	2748,5	1318,5	1430	215	191	160	G4
E10R35/11A+MAC8100	244	390	2890,5	1390,5	1500	215	191	160	G4
E10R35/11A+MAC10100A	251	455	2796,5	1390,5	1406	215	242	160	G4
E10R35/12A+MAC8125	244	430	3147,5	1462,5	1685	215	191	160	G4
E10R35/12A+MAC10125A	251	503	2998,5	1462,5	1536	215	242	160	G4
E10R35/13A+MAC8125	244	440	3219,5	1534,5	1685	215	191	160	G4
E10R35/13A+MAC10125A	251	513	3070,5	1534,5	1536	215	242	160	G4
E10RB35/14A+MAC8125	244	460	3379,5	1694,5	1685	215	191	160	G4
E10RB35/14A+MAC10125A	251	533	3230,5	1694,5	1536	215	242	160	G4
E10RB35/15A+MAC8150	244	488	3526,5	1766,5	1760	215	191	160	G4
E10RB35/15A+MAC10150A	251	578	3407,5	1766,5	1641	215	242	160	G4
E10RB35/16A+MAC8150	244	498	3598,5	1838,5	1760	215	191	160	G4
E10RB35/16A+MAC10150A	251	588	3479,5	1838,5	1641	215	242	160	G4
E10RB35/17A+MAC8150	244	508	3670,5	1910,5	1760	215	191	160	G4
E10RB35/17A+MAC10150A	251	598	3551,5	1910,5	1641	215	242	160	G4
E10RB35/18A+MAC10180A	251	643	3748,5	1982,5	1766	215	242	160	G4
E10RB35/19A+MAC10180A	251	653	3820,5	2054,5	1766	215	242	160	G4
E10RB35/20A+MAC10180A	251	663	3892,5	2126,5	1766	215	242	160	G4
E10RB35/21A+MAC10200A	251	701	4064,5	2198,5	1866	215	242	160	G4

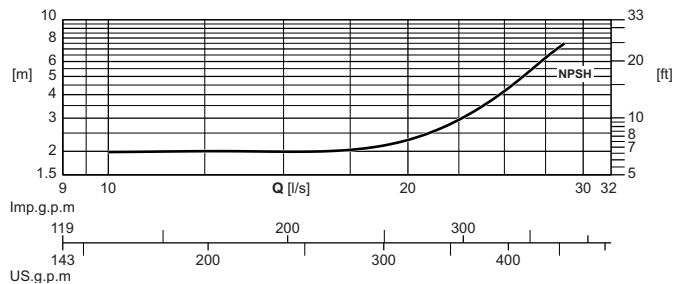
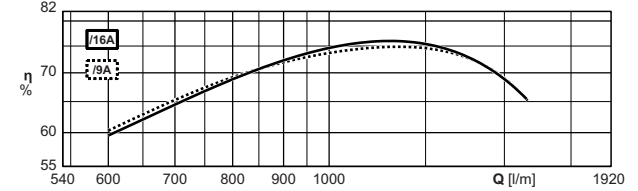
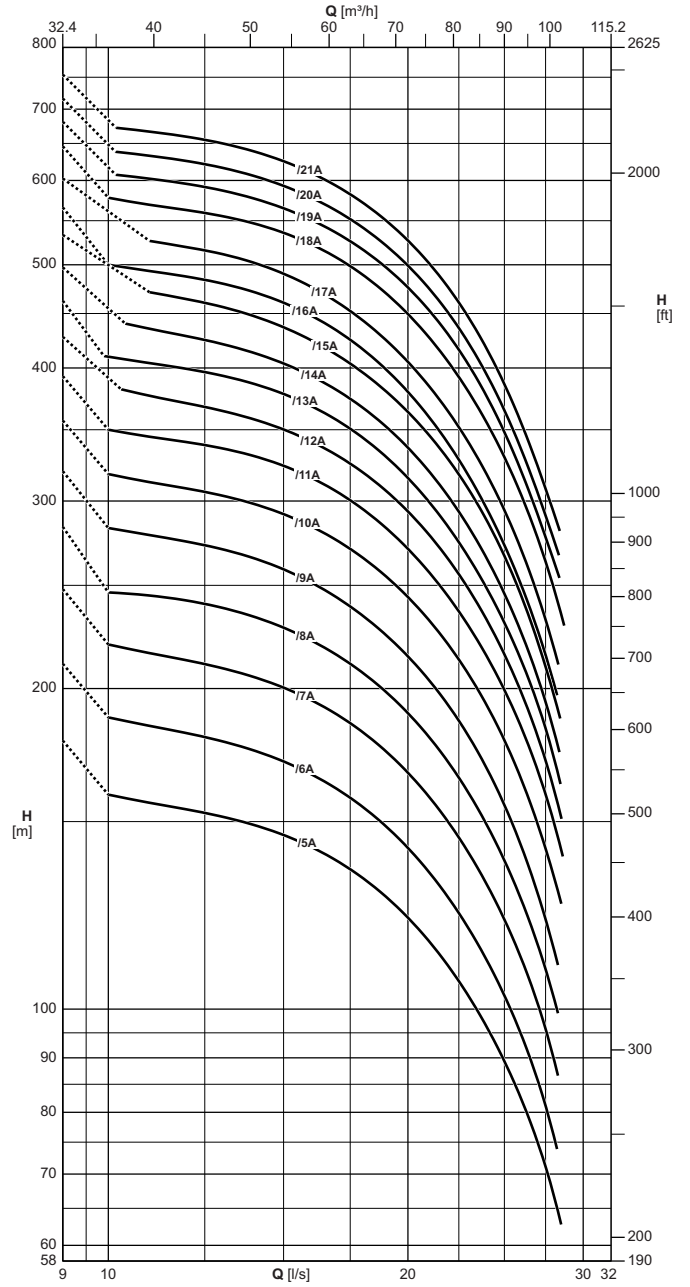

The hydraulic performance characteristics are guaranteed as conforming to standard UNI/ISO 9906 Grade 3B. Available with NPT thread.

Les caractéristiques hydrauliques de fonctionnement sont garanties conformes à la norme UNI/ISO 9906 Niveau 3B. Disponible avec filetage NPT.

Le caratteristiche di funzionamento vengono garantite secondo la norma: UNI/ISO 9906 Grado 3B. Disponibile con filettatura NPT.

Electric pump type Electropompe type Elettropompa tipo	Motor power Puisse. moteur Potenza motore		Horizontal installation Installation horizontale Installazione orizzontale	Check valve $\varnothing$ Clapet de retenue $\varnothing$ Valvola di ritegno $\varnothing$	Capacity Debit Portata									
					[l/s]	0	10	12,5	15	17,5	20	22,5	25	27,5
	[l/min]	0			600	750	900	1050	1200	1350	1500	1650		
	[m <sup>3</sup> /h]	0			36	45	54	63	72	81	90	99		
[kW]	[HP]	Head Hauteur Prevalenza												
E10R35/5A+MAC850	37	50	■	4" Gas	[m]	179	159	153	146	135	121	106	89	71
E10R35/6A+MAC850	37	50	■	4" Gas	[m]	211	188	180	171	158	142	123	103	81
E10R35/7A+MAC860	45	60	■	4" Gas	[m]	248	220	211	200	185	166	145	121	95
E10R35/8A+MAC870	51	70	■	4" Gas	[m]	284	246	240	228	211	189	165	137	108
E10R35/9A+MAC880	59	80	■	4" Gas	[m]	320	283	273	259	239	214	186	155	121
E10R35/10A+MAC890	66	90	■	4" Gas	[m]	357	318	306	292	270	243	213	179	141
E10R35/11A+MAC8100	75	100	○	4" Gas	[m]	393	350	338	324	300	270	236	199	158
E10R35/11A+MAC10100A	75	100	■	4" Gas	[m]	393	350	338	324	300	270	236	199	158
E10R35/12A+MAC8125	92	125	○	4" Gas	[m]	428	-	368	350	325	293	256	215	171
E10R35/12A+MAC10125A	92	125	■	4" Gas	[m]	431	386	372	356	332	299	262	222	176
E10R35/13A+MAC8125	92	125	○	4" Gas	[m]	463	410	396	378	350	315	274	231	184
E10R35/13A+MAC10125A	92	125	■	4" Gas	[m]	466	420	402	384	358	323	283	237	190
E10RB35/14A+MAC8125	92	125	○	4" Gas	[m]	497	-	425	403	374	337	293	246	193
E10RB35/14A+MAC10125A	92	125	■	4" Gas	[m]	503	451	434	414	385	347	304	257	205
E10RB35/15A+MAC8150	110	150	○	4" Gas	[m]	533	-	460	437	403	364	317	267	209
E10RB35/15A+MAC10150A	110	150	■	4" Gas	[m]	541	489	470	450	418	379	332	281	224
E10RB35/16A+MAC8150	110	150	○	4" Gas	[m]	566	500	484	461	425	380	328	273	215
E10RB35/16A+MAC10150A	110	150	■	4" Gas	[m]	575	517	497	474	442	400	349	295	236
E10RB35/17A+MAC8150	110	150	○	4" Gas	[m]	602	-	515	490	453	405	352	294	231
E10RB35/17A+MAC10150A	110	150	■	4" Gas	[m]	609	-	528	505	471	428	376	316	250
E10RB35/18A+MAC10180A	132	180	■	4" Gas	[m]	646	578	559	535	499	448	392	331	262
E10RB35/19A+MAC10180A	132	180	■	4" Gas	[m]	681	-	591	565	525	476	415	349	277
E10RB35/20A+MAC10180A	132	180	■	4" Gas	[m]	716	-	621	594	551	498	436	365	291
E10RB35/21A+MAC10200A	150	200	○	4" Gas	[m]	754	-	655	626	583	527	462	386	309
NPSH					[m]	-	2	2	2	2,1	2,4	2,9	4,1	6,7

■ Without conical valve

□ On request

○ Please contact our sales organisation

For motor performances specification see page "motor features"

Temperature monitoring device for submersed electric motors 6" + 14": see page "Accessories"

■ Sans soupape du clapet.

□ Sur demande

○ Contacter notre service commercial.

Pour caractéristiques techniques moteurs voir page "Caractéristiques des moteurs"

Appareillage de contrôle de la température des moteurs électriques immergés 6" + 14": voir page "Accessories"

■ Senza clapet valvola di ritegno

□ Su richiesta

○ Interpellare la sede o la rete di vendita

Per caratteristiche motori vedere pagina "caratteristiche motori"

Apparecchiatura di controllo temperatura motori elettrici sommersi 6" + 14": vedere pagina accessori

Operating data  
 Caracteristiques de fonctionnement  
 Caratteristiche di funzionamento

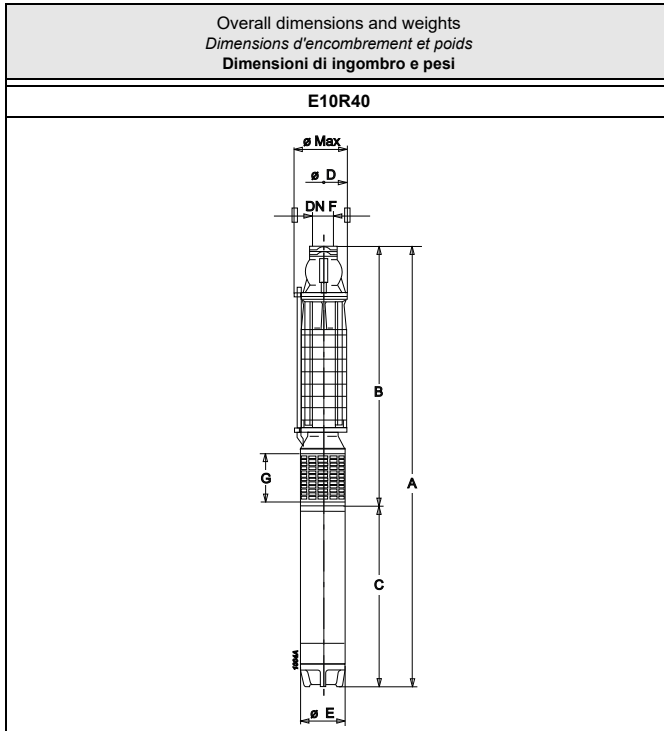

Type Type Tipo	ø max	Weight Poids Peso	A	B	C	D	E	G	F
	[mm]								
E10R40/4B+MAC840	244	234	2018,5	958,5	1060	215	191	160	G4
E10R40/4A+MAC850	244	246	2073,5	958,5	1115	215	191	160	G4
E10R40/5I+MAC860	244	273	2243,5	1048,5	1195	215	191	160	G4
E10R40/6K+MAC870	244	303	2428,5	1138,5	1290	215	191	160	G4
E10R40/7M+MAC880	244	331	2623,5	1228,5	1395	215	191	160	G4
E10R40/8AB+MAC890	244	350	2748,5	1318,5	1430	215	191	160	G4
E10R40/8A+MAC8100	244	366	2818,5	1318,5	1500	215	191	160	G4
E10R40/8A+MAC10100A	251	431	2724,5	1318,5	1406	215	242	160	G4
E10R40/9A+MAC8125	244	406	3093,5	1408,5	1685	215	191	160	G4
E10R40/9A+MAC10125A	251	479	2944,5	1408,5	1536	215	242	160	G4
E10R40/10A+MAC8125	244	416	3183,5	1498,5	1685	215	191	160	G4
E10R40/10A+MAC10125A	251	489	3034,5	1498,5	1536	215	242	160	G4
E10R40/11A+MAC8150	244	444	3348,5	1588,5	1760	215	191	160	G4
E10R40/11A+MAC10150A	251	534	3229,5	1588,5	1641	215	242	160	G4
E10R40/12A+MAC8150	244	454	3438,5	1678,5	1760	215	191	160	G4
E10R40/12A+MAC10150A	251	544	3319,5	1678,5	1641	215	242	160	G4
E10RB40/13A+MAC10180A	251	597	3622,5	1856,5	1766	215	242	160	G4
E10RB40/14A+MAC10180A	251	607	3712,5	1946,5	1766	215	242	160	G4
E10RB40/15A+MAC10200A	251	645	3902,5	2036,5	1866	215	242	160	G4
E10RB40/16A+MAC10200A	251	655	3992,5	2126,5	1866	215	242	160	G4
E10RB40/17A+MAC10220A	251	695	4242,5	2216,5	2026	215	242	160	G4
E10RB40/18A+MAC10220A	251	705	4332,5	2306,5	2026	215	242	160	G4

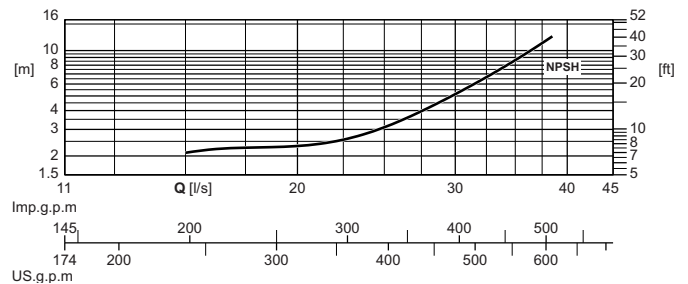
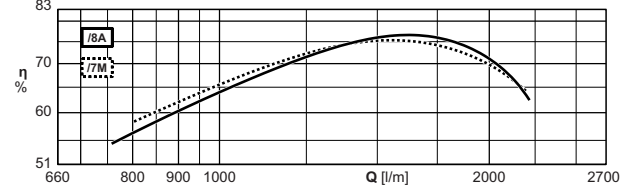
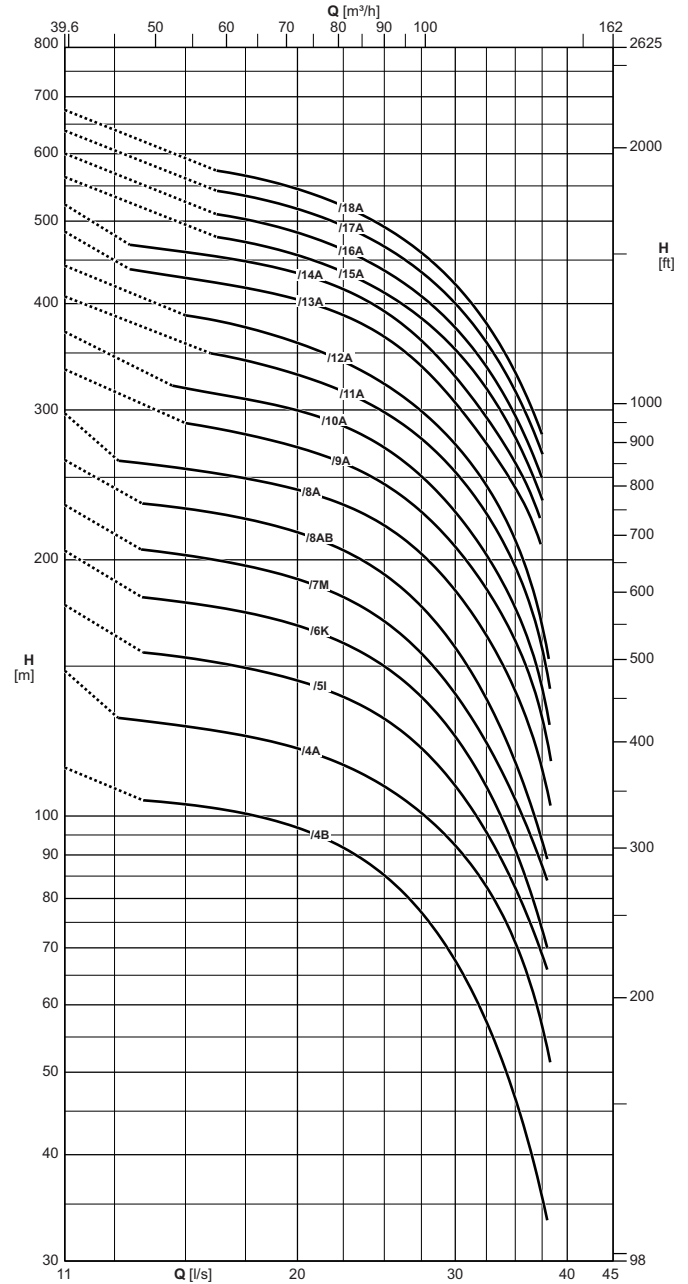

The hydraulic performance characteristics are guaranteed as conforming to standard UNI/ISO 9906 Grade 3B. Available with NPT thread.

Les caractéristiques hydrauliques de fonctionnement sont garanties conformes à la norme UNI/ISO 9906 Niveau 3B. Disponible avec filetage NPT.

Le caratteristiche di funzionamento vengono garantite secondo la norma: UNI/ISO 9906 Grado 3B. Disponibile con filettatura NPT.

Operating data  
Caracteristiques de fonctionnement  
Caratteristiche di funzionamento

Electric pump type Electropompe type Elettropompa tipo	Motor power Puis. moteur Potenza motore		Horizontal installation Installation horizontale Installazione orizzontale	Check valve $\varnothing$ Clapet de retenue $\varnothing$ Valvola di ritegno $\varnothing$	Capacity Debit Portata											
	[kW]	[HP]			[l/s]	0	15	17,5	20	22,5	25	27,5	30	32,5	35	37,5
					[l/min]	0	900	1050	1200	1350	1500	1650	1800	1950	2100	2250
					[m <sup>3</sup> /h]	0	54	63	72	81	90	99	108	117	126	135
					Head Hauteur Prevalenza											
E10R40/4B+MAC840	30	40	■	4" Gas	[m]	114	103	100	97	92	85	77	67	57	46,5	35,5
E10R40/4A+MAC850	37	50	■	4" Gas	[m]	148	127	124	120	115	108	101	92	82	71	56
E10R40/5I+MAC860	45	60	■	4" Gas	[m]	177	153	149	144	138	130	120	108	95	82	69
E10R40/6K+MAC870	51	70	■	4" Gas	[m]	205	178	173	167	160	150	138	124	108	91	73
E10R40/7M+MAC880	59	80	■	4" Gas	[m]	232	202	197	190	181	169	155	139	122	104	87
E10R40/8AB+MAC890	66	90	■	4" Gas	[m]	262	230	223	215	205	192	176	157	137	115	93
E10R40/8A+MAC8100	75	100	○	4" Gas	[m]	297	256	249	241	232	219	203	184	163	140	113
E10R40/8A+MAC10100A	75	100	■	4" Gas	[m]	300	258	252	243	234	221	205	187	167	145	119
E10R40/9A+MAC8125	92	125	○	4" Gas	[m]	335	289	281	271	260	245	228	207	184	161	130
E10R40/9A+MAC10125A	92	125	■	4" Gas	[m]	338	292	285	276	265	251	233	212	190	166	137
E10R40/10A+MAC8125	92	125	○	4" Gas	[m]	371	318	309	299	287	271	250	227	203	175	141
E10R40/10A+MAC10125A	92	125	■	4" Gas	[m]	374	324	315	305	292	276	257	234	209	183	150
E10R40/11A+MAC8150	110	150	○	4" Gas	[m]	408	-	343	330	315	298	277	254	226	196	157
E10R40/11A+MAC10150A	110	150	■	4" Gas	[m]	415	360	352	341	328	310	288	263	235	207	172
E10R40/12A+MAC8150	110	150	○	4" Gas	[m]	443	387	375	360	342	322	299	273	245	211	166
E10R40/12A+MAC10150A	110	150	■	4" Gas	[m]	452	391	380	367	351	332	309	282	251	217	177
E10RB40/13A+MAC10180A	132	180	■	4" Gas	[m]	486	429	417	404	388	365	338	306	273	243	-
E10RB40/14A+MAC10180A	132	180	■	4" Gas	[m]	523	460	448	434	416	392	362	328	294	259	-
E10RB40/15A+MAC10200A	150	200	○	4" Gas	[m]	563	-	472	456	436	412	385	353	318	279	235
E10RB40/16A+MAC10200A	150	200	○	4" Gas	[m]	600	-	503	485	463	438	408	375	337	296	249
E10RB40/17A+MAC10220A	160	220	○	4" Gas	[m]	639	-	535	516	494	466	436	400	360	316	266
E10RB40/18A+MAC10220A	160	220	○	4" Gas	[m]	675	-	565	545	521	492	459	422	379	333	281
NPSH					[m]	-	2,1	2,2	2,4	3	3,5	4,3	5,2	6,7	8,7	11

■ Without conical valve

□ On request

○ Please contact our sales organisation

For motor performances specification see page "motor features"

Temperature monitoring device for submersed electric motors 6" + 14": see page "Accessories"

■ Sans soupape du clapet.

□ Sur demande

○ Contacter notre service commercial.

Pour caractéristiques techniques moteurs voir page "Caractéristiques des moteurs"

Appareillage de contrôle de la température des moteurs électriques immergés 6" + 14": voir page "Accessories"

■ Senza clapet valvola di ritegno

□ Su richiesta

○ Interpellare la sede o la rete di vendita

Per caratteristiche motori vedere pagina "caratteristiche motori"

Apparecchiatura di controllo temperatura motori elettrici sommersi 6" + 14": vedere pagina accessori



Operating data  
Caracteristiques de fonctionnement  
Caratteristiche di funzionamento

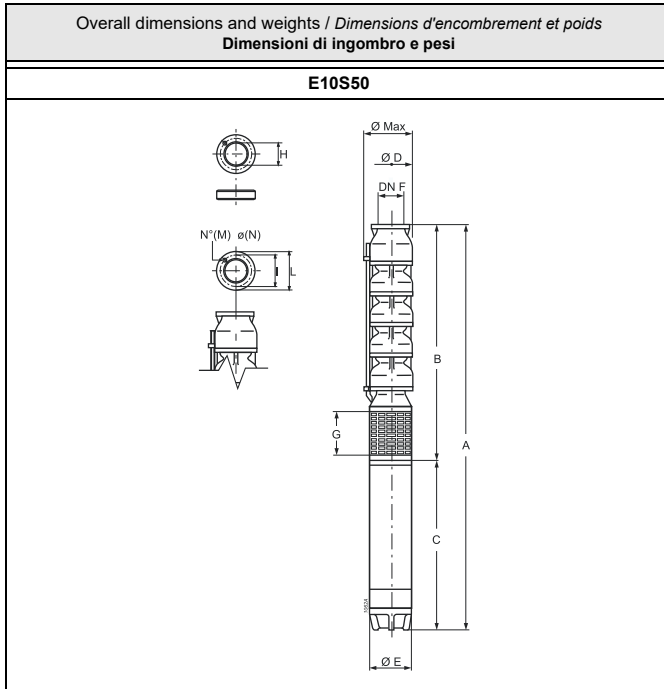

Type Type Tipo	Ø max [mm]	Weight Poids Peso [kg]	A	B	C	D	E	G	F
			[mm]						
E10S50/1H+MAC612A	250	120,7	1380	680	700	240	143	198	150
E10S50/1F+MAC615A	250	125	1395	680	715	240	143	198	150
E10S50/1D+MAC617A	250	129	1430	680	750	240	143	198	150
E10S50/1B+MAC620A	250	132,8	1470	680	790	240	143	198	150
E10S50/2G+MAC625A	250	155,2	1675	845	830	240	143	198	150
E10S50/2E+MAC630A	250	165,5	1765	845	920	240	143	198	150
E10S50/2CD+MAC635A	250	180,3	1900	845	1055	240	143	198	150
E10S50/2B+MAC640A	250	192,9	2010	845	1165	240	143	198	150
E10S50/2B+MAC840	250	232	1933,5	873,5	1060	240	191	198	150
E10S50/3D+MAC650B	250	228	2317,5	1035,5	1282	240	143	198	150
E10S50/3B+MAC660B	250	232,3	2357,5	1035,5	1322	240	143	198	150
E10S50/3D+MAC850	250	262	2153,5	1038,5	1115	240	191	198	150
E10S50/3B+MAC860	250	279	2233,5	1038,5	1195	240	191	198	150
E10S50/4CD+MAC870	250	317	2493,5	1203,5	1290	240	191	198	150
E10S50/4B+MAC880	250	335	2598,5	1203,5	1395	240	191	198	150
E10S50/5CD+MAC890	250	362	2798,5	1368,5	1430	240	191	198	150
E10S50/5B+MAC8100	250	378	2868,5	1368,5	1500	240	191	198	150
E10S50/5B+MAC10100A	251	443	2774,5	1368,5	1406	240	242	198	150
E10S50/6C+MAC8125	250	426	3218,5	1533,5	1685	240	191	198	150
E10S50/6C+MAC10125A	251	499	3069,5	1533,5	1536	240	242	198	150
E10S50/7CD+MAC8125	250	444	3383,5	1698,5	1685	240	191	198	150
E10S50/7CD+MAC10125A	251	517	3234,5	1698,5	1536	240	242	198	150
E10S50/8C+MAC8150	250	480	3623,5	1863,5	1760	240	191	198	150
E10S50/8C+MAC10150A	251	570	3504,5	1863,5	1641	240	242	198	150
E10S50/8B+MAC10180A	251	605	3629,5	1863,5	1766	240	242	198	150
E10S50/9BC+MAC10180A	251	623	3794,5	2028,5	1766	240	242	198	150
E10S50/10B+MAC10200A	251	660	4059,5	2193,5	1866	240	242	198	150
E10S50/11B+MAC10220A	251	702	4384,5	2358,5	2026	240	242	198	150
E10S50/12JC+MAC10250A	251	757	4649,5	2523,5	2126	240	242	198	150
E10S50/12JC+MAC12230A	296	987	4602	2644	1958	290	290	198	150
E10S50/13B+MAC10250A	251	779	4814,5	2688,5	2126	240	242	198	150
E10S50/13B+MAC12260A	296	1073	4917	2809	2108	290	290	198	150
E10S50/14B+MAC12300C	296	1023	4932	2974	1958	290	290	198	150
E10S50/15B+MAC12300C	296	1041	5097	3139	1958	290	290	198	150

Holes Trous Fori		I	L	Counterflange Contrebride Controflangia
M	N			
N°		Ø [mm]		
6	16	206	234	170.5

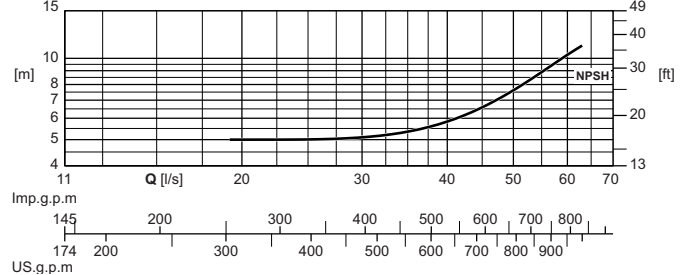
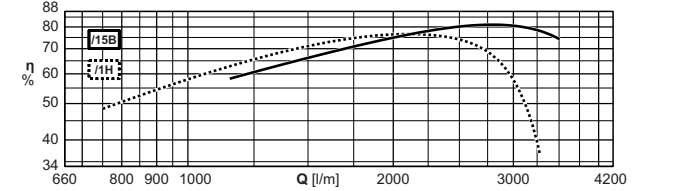
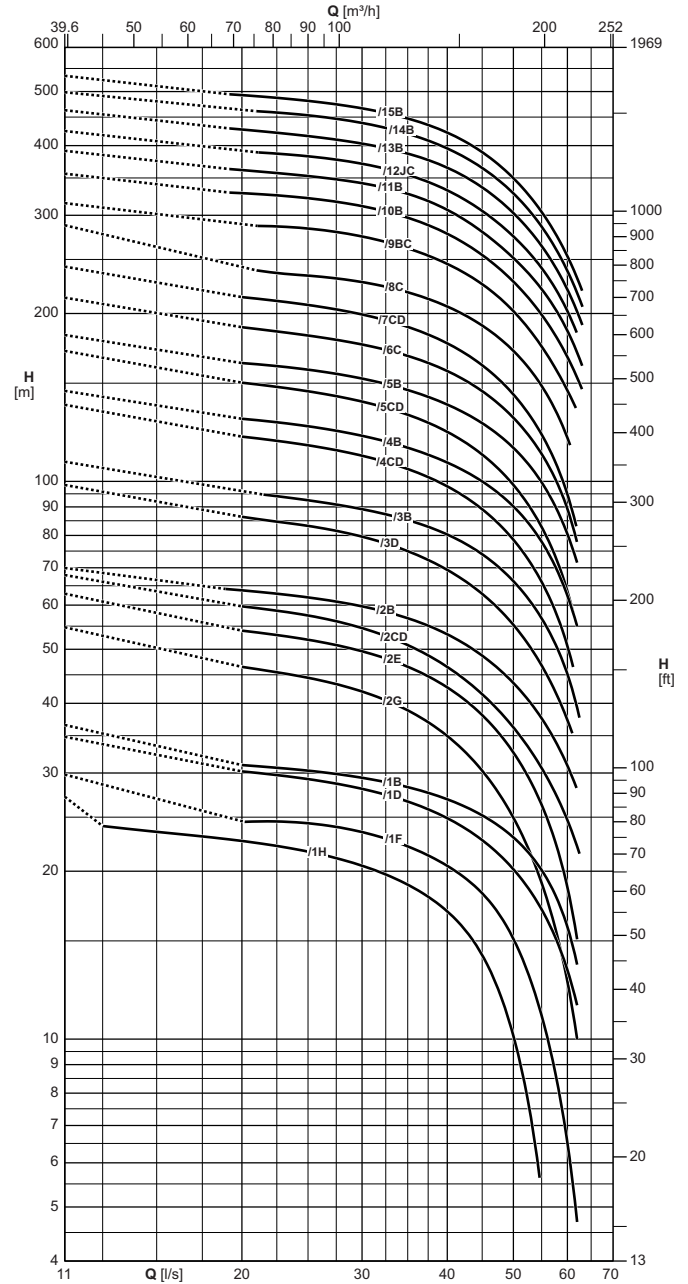

Pumps is equipped with gasket, counterflange and bolts.  
The hydraulic performance characteristics are guaranteed as conforming to standard UNI/ISO 9906 Grade 3B.

La pompe est équipée avec garniture, contrebride et boulons.  
Les caractéristiques hydrauliques de fonctionnement sont garanties conformes à la norme UNI/ISO 9906 Niveau 3B.

La pompa è corredata di guarnizione, controflangia e bulloni  
Le caratteristiche di funzionamento vengono garantite secondo la norma: UNI/ISO 9906 Grado 3B.

Operating data  
Caracteristiques de fonctionnement  
Caratteristiche di funzionamento

Electric pump type Electropompe type Elettropompa tipo	Motor power Puiss. moteur Potenza motore		Horizontal installation Installation horizontale Installazione orizzontale	Check valve $\varnothing$ Clapet de retenue $\varnothing$ Valvola di ritegno $\varnothing$	Capacity Debit Portata											
	[kW]	[HP]			[l/s]	0	15	20	25	30	35	40	45	50	55	60
					[l/min]	0	900	1200	1500	1800	2100	2400	2700	3000	3300	3600
					[m <sup>3</sup> /h]	0	54	72	90	108	126	144	162	180	198	216
		Head Hauteur Prevalenza														
E10S50/1H+MAC612A	9,2	12,5	<input type="checkbox"/>	$\varnothing$ 150	[m]	27	23,5	22,5	21,5	20,5	19	17	14	10	-	-
E10S50/1F+MAC615A	11	15	<input type="checkbox"/>	$\varnothing$ 150	[m]	30	-	-	24,5	23,5	22	20,5	18	15	11	6,5
E10S50/1D+MAC617A	13	17,5	<input type="checkbox"/>	$\varnothing$ 150	[m]	35	-	30	29	28	26,5	25	22,5	20	17	13,5
E10S50/1B+MAC620A	15	20	<input type="checkbox"/>	$\varnothing$ 150	[m]	36,5	-	31	30,5	29,5	28,5	27	25	23	20	16
E10S50/2G+MAC625A	18,5	25	<input type="checkbox"/>	$\varnothing$ 150	[m]	55	-	46,5	44,5	42	39	35	30,5	25	19	12,5
E10S50/2E+MAC630A	22	30	<input type="checkbox"/>	$\varnothing$ 150	[m]	63	-	54	52	49,5	46,5	42,5	38	32,5	26,5	18,5
E10S50/2CD+MAC635A	26	35	<input type="checkbox"/>	$\varnothing$ 150	[m]	68	-	60	57	54	51	46,5	41,5	36	30,5	24,5
E10S50/2B+MAC640A	30	40	<input type="checkbox"/>	$\varnothing$ 150	[m]	70	-	64	62	60	57	53	48,5	43,5	37,5	31
E10S50/2B+MAC840	30	40	<input type="checkbox"/>	$\varnothing$ 150	[m]	73	-	65	64	61	58	55	51	46	40	32,5
E10S50/3D+MAC650B	37	50	<input type="checkbox"/>	$\varnothing$ 150	[m]	98	-	86	83	79	75	69	63	55	46,5	37,5
E10S50/3B+MAC660B	45	60	<input type="checkbox"/>	$\varnothing$ 150	[m]	108	-	-	92	89	85	80	74	66	57	45
E10S50/3D+MAC850	37	50	<input type="checkbox"/>	$\varnothing$ 150	[m]	101	-	89	86	82	78	72	66	58	48	36,5
E10S50/3B+MAC860	45	60	<input type="checkbox"/>	$\varnothing$ 150	[m]	110	-	98	95	92	87	82	76	69	60	48
E10S50/4CD+MAC870	51	70	<input type="checkbox"/>	$\varnothing$ 150	[m]	137	-	120	116	111	105	98	89	78	66	51
E10S50/4B+MAC880	59	80	<input type="checkbox"/>	$\varnothing$ 150	[m]	145	-	129	125	121	115	108	100	90	78	62
E10S50/5CD+MAC890	66	90	<input type="checkbox"/>	$\varnothing$ 150	[m]	171	-	150	145	139	132	122	111	98	83	63
E10S50/5B+MAC8100	75	100	<input type="checkbox"/>	$\varnothing$ 150	[m]	183	-	163	158	153	146	137	127	115	100	80
E10S50/5B+MAC10100A	75	100	<input type="checkbox"/>	$\varnothing$ 150	[m]	183	-	166	162	156	149	140	130	117	102	84
E10S50/6C+MAC8125	92	125	<input type="checkbox"/>	$\varnothing$ 150	[m]	213	-	189	182	176	168	158	145	130	112	89
E10S50/6C+MAC10125A	92	125	<input type="checkbox"/>	$\varnothing$ 150	[m]	213	-	189	182	176	168	158	145	130	112	89
E10S50/7CD+MAC8125	92	125	<input type="checkbox"/>	$\varnothing$ 150	[m]	243	-	214	207	199	189	177	161	143	121	94
E10S50/7CD+MAC10125A	92	125	<input type="checkbox"/>	$\varnothing$ 150	[m]	243	-	214	207	199	189	177	161	143	121	94
E10S50/8C+MAC8150	110	150	<input type="checkbox"/>	$\varnothing$ 150	[m]	288	-	-	234	227	218	206	190	171	148	120
E10S50/8C+MAC10150A	110	150	<input type="checkbox"/>	$\varnothing$ 150	[m]	285	-	252	244	236	225	211	194	175	151	121
E10S50/8B+MAC10180A	132	180	<input type="checkbox"/>	$\varnothing$ 150	[m]	295	-	265	258	250	240	227	211	191	168	138
E10S50/9BC+MAC10180A	132	180	<input type="checkbox"/>	$\varnothing$ 150	[m]	315	-	-	284	275	262	245	225	202	174	145
E10S50/10B+MAC10200A	150	200	<input type="checkbox"/>	$\varnothing$ 150	[m]	356	-	329	322	311	297	278	255	228	199	167
E10S50/11B+MAC10220A	160	220	<input type="checkbox"/>	$\varnothing$ 150	[m]	391	-	362	353	342	328	307	280	251	221	186
E10S50/12JC+MAC10250A	185	250	<input type="checkbox"/>	$\varnothing$ 150	[m]	425	-	-	383	371	354	333	305	275	241	202
E10S50/12JC+MAC12230A	170	230	<input type="checkbox"/>	$\varnothing$ 150	[m]	425	-	-	385	373	355	333	306	275	239	200
E10S50/13B+MAC10250A	185	250	<input type="checkbox"/>	$\varnothing$ 150	[m]	463	-	427	416	403	387	365	336	303	264	221
E10S50/13B+MAC12260A	190	260	<input type="checkbox"/>	$\varnothing$ 150	[m]	464	-	429	421	407	389	365	334	300	262	220
E10S50/14B+MAC12300C	220	300	<input type="checkbox"/>	$\varnothing$ 150	[m]	499	-	-	453	439	420	395	365	328	286	238
E10S50/15B+MAC12300C	220	300	<input type="checkbox"/>	$\varnothing$ 150	[m]	534	-	493	481	466	447	422	389	349	304	253
NPSH					[m]	-	5	5	5	5,1	5,2	5,7	6,4	7,1	8,3	10

Without conical valve

On request

Please contact our sales organisation

For motor performances specification see page "motor features"

Sans soupape du clapet.

Sur demande

Contacter notre service commercial.

Pour caractéristiques techniques moteurs voir page "Caractéristiques des moteurs"

Senza clapet valvola di ritegno

Su richiesta

Interpellare la sede o la rete di vendita

Per caratteristiche motori vedere pagina "caratteristiche motori"

Temperature monitoring device for submersed electric motors 6" + 14": see page "Accessories"

Appareillage de contrôle de la température des moteurs électriques immergés 6" + 14": voir page "Accessories"

Apparecchiatura di controllo temperatura motori elettrici sommersi 6" + 14": vedere pagina accessori

Operating data  
 Caracteristiques de fonctionnement  
 Caratteristiche di funzionamento

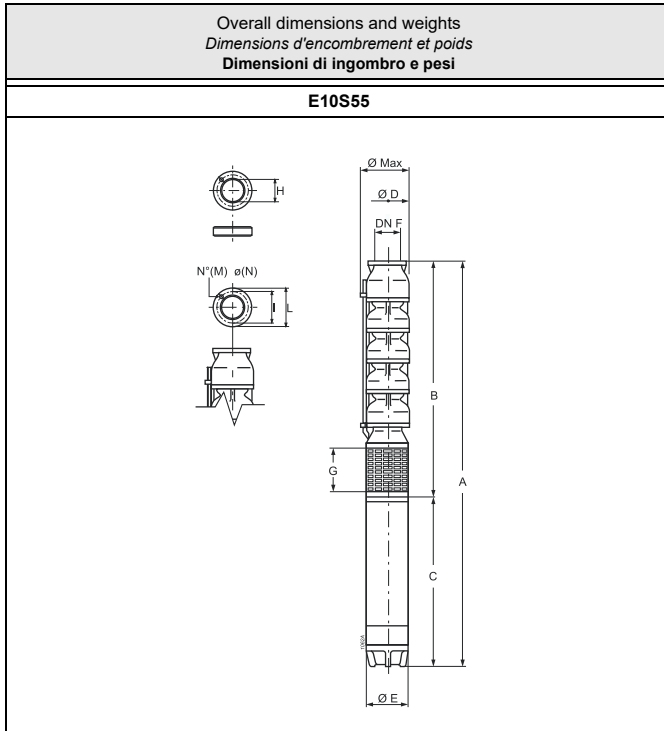

Type Type Tipo	Ø max [mm]	Weight Poids Peso [kg]	A	B	C	D	E	G	F
			[mm]						
E10S55/2B+MAC640A	250	192,9	2010	845	1165	240	143	198	150
E10S55/2A+MAC650B	250	210	2127	845	1282	240	143	198	150
E10S55/2B+MAC840	250	232	1933,5	873,5	1060	240	191	198	150
E10S55/2A+MAC850	250	244	1988,5	873,5	1115	240	191	198	150
E10S55/3C+MAC650B	250	228	2317,5	1035,5	1282	240	143	198	150
E10S55/3K+MAC660B	250	232,3	2357,5	1035,5	1322	240	143	198	150
E10S55/3C+MAC850	250	262	2153,5	1038,5	1115	240	191	198	150
E10S55/3K+MAC860	250	279	2233,5	1038,5	1195	240	191	198	150
E10S55/3A+MAC870	250	299	2328,5	1038,5	1290	240	191	198	150
E10S55/4S+MAC870	250	317	2493,5	1203,5	1290	240	191	198	150
E10S55/4K+MAC880	250	335	2598,5	1203,5	1395	240	191	198	150
E10S55/4A+MAC890	250	344	2633,5	1203,5	1430	240	191	198	150
E10S55/5A+MAC8100	250	378	2868,5	1368,5	1500	240	191	198	150
E10S55/5A+MAC10125A	251	481	2904,5	1368,5	1536	240	242	198	150
E10S55/6A+MAC8125	250	426	3218,5	1533,5	1685	240	191	198	150
E10S55/6A+MAC10125A	251	499	3069,5	1533,5	1536	240	242	198	150
E10S55/7A+MAC8150	250	462	3458,5	1698,5	1760	240	191	198	150
E10S55/7A+MAC10150A	251	552	3339,5	1698,5	1641	240	242	198	150
E10S55/8A+MAC10180A	251	605	3629,5	1863,5	1766	240	242	198	150
E10S55/9K+MAC10180A	251	624	3794,5	2028,5	1766	240	242	198	150
E10S55/10A+MAC10200A	251	666	4059,5	2193,5	1866	240	242	198	150
E10S55/11A+MAC10250A	251	747	4484,5	2358,5	2126	240	242	198	150
E10S55/11A+MAC12230A	296	969	4437	2479	1958	290	290	198	150
E10S55/12A+MAC10250A	251	765	4649,5	2523,5	2126	240	242	198	150
E10S55/12A+MAC12260A	296	1055	4752	2644	2108	290	290	198	150
E10S55/13A+MAC12300C	296	1005	4767	2809	1958	290	290	198	150
E10S55/14A+MAC12300C	296	1023	4932	2974	1958	290	290	198	150
E10S55/15A+MAC12340C	296	1109	5247	3139	2108	290	290	198	150

Holes Trous Fori		I	L	Counterflange Contrebride Controflangia
M	N			H
N°		Ø [mm]		
6	16	206	234	170,5

Pumps is equipped with gasket, counterflange and bolts.  
 The hydraulic performance characteristics are guaranteed as conforming to standard UNI/ISO 9906 Grade 3B.

La pompe est équipée avec garniture, contrebride et boulons.  
 Les caractéristiques hydrauliques de fonctionnement sont garanties conformes à la norme UNI/ISO 9906 Niveau 3B.

La pompa è corredata di guarnizione, controflangia e bulloni  
 Le caratteristiche di funzionamento vengono garantite secondo la norma: UNI/ISO 9906 Grado 3B.

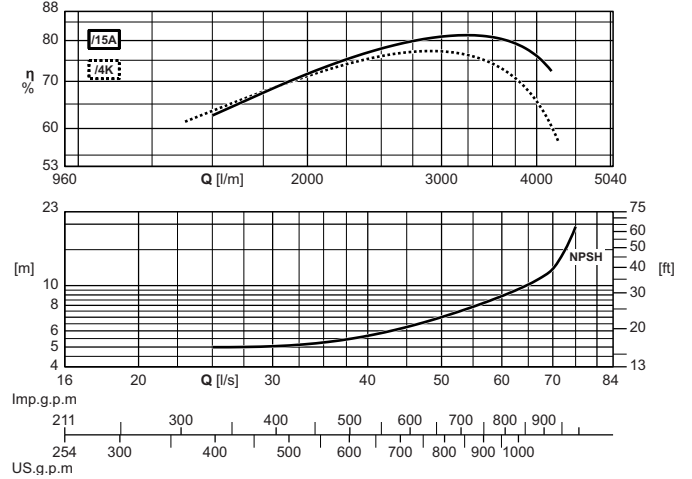
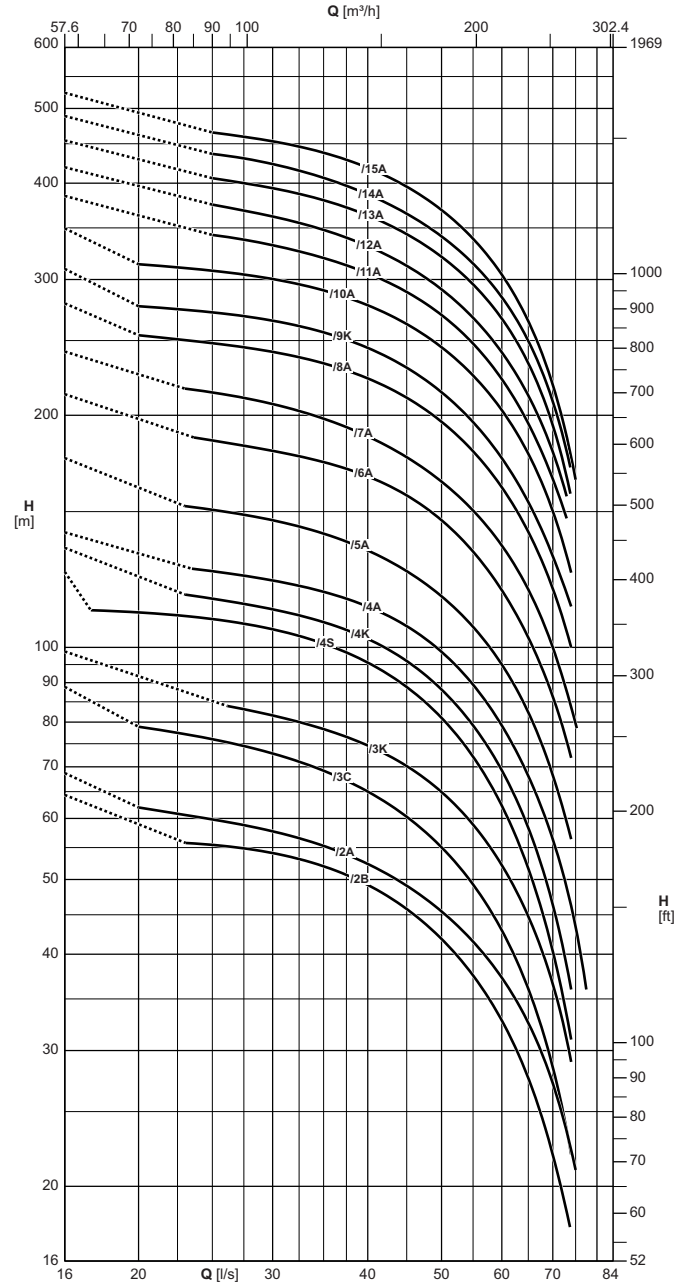

Operating data  
Caracteristiques de fonctionnement  
Caratteristiche di funzionamento

Electric pump type Electropompe type Elettropompa tipo	Motor power Puisse. moteur Potenza motore		Horizontal installation Installation horizontale Installazione orizzontale	Check valve $\varnothing$ Clapet de retenue $\varnothing$ Valvola di ritegno $\varnothing$	Capacity Debit Portata													
	[kW]	[HP]			[l/s]	0	20	25	30	35	40	45	50	55	60	65	70	75
					[l/min]	0	1200	1500	1800	2100	2400	2700	3000	3300	3600	3900	4200	4500
					[m <sup>3</sup> /h]	0	72	90	108	126	144	162	180	198	216	234	252	270
		Head Hauteur Prevalenza																
E10S55/2B+MAC640A	30	40	<input type="radio"/>	$\varnothing$ 150	[m]	64	-	55	54	52	49	46	42	37,5	33	27,5	22	-
E10S55/2A+MAC650B	37	50	<input type="radio"/>	$\varnothing$ 150	[m]	69	62	60	58	55	52	49	45,5	41,5	37,5	32,5	27	21
E10S55/2B+MAC840	30	40	<input type="checkbox"/>	$\varnothing$ 150	[m]	65	57	56	55	53	50	47	43,5	39,5	35	30	24,5	-
E10S55/2A+MAC850	37	50	<input type="checkbox"/>	$\varnothing$ 150	[m]	71	64	62	60	58	56	52	48,5	44	39	34	28,5	-
E10S55/3C+MAC650B	37	50	<input type="radio"/>	$\varnothing$ 150	[m]	89	79	76	73	69	65	60	55	49	43	36	28,5	-
E10S55/3K+MAC660B	45	60	<input type="radio"/>	$\varnothing$ 150	[m]	99	-	-	81	78	74	70	65	59	52	44,5	36,5	-
E10S55/3C+MAC850	37	50	<input type="checkbox"/>	$\varnothing$ 150	[m]	91	81	80	77	74	70	65	59	52	45	37	28,5	-
E10S55/3K+MAC860	45	60	<input type="checkbox"/>	$\varnothing$ 150	[m]	100	89	87	84	81	77	73	67	61	54	45,5	37,5	-
E10S55/3A+MAC870	51	70	<input type="checkbox"/>	$\varnothing$ 150	[m]	106	-	94	90	87	83	79	73	66	59	51	42,5	34
E10S55/4S+MAC870	51	70	<input type="checkbox"/>	$\varnothing$ 150	[m]	125	111	109	105	101	95	89	81	72	62	52	40,5	-
E10S55/4K+MAC880	59	80	<input type="checkbox"/>	$\varnothing$ 150	[m]	134	-	116	112	108	102	96	88	79	69	58	46,5	-
E10S55/4A+MAC890	66	90	<input type="checkbox"/>	$\varnothing$ 150	[m]	141	-	125	122	118	113	106	99	89	79	68	56	43,5
E10S55/5A+MAC8100	75	100	<input type="radio"/>	$\varnothing$ 150	[m]	176	-	151	146	140	133	125	116	106	95	82	68	-
E10S55/5A+MAC10125A	92	125	<input type="checkbox"/>	$\varnothing$ 150	[m]	178	-	156	151	146	140	132	123	112	100	87	73	-
E10S55/6A+MAC8125	92	125	<input type="radio"/>	$\varnothing$ 150	[m]	213	-	185	180	174	166	157	146	133	118	103	86	-
E10S55/6A+MAC10125A	92	125	<input type="checkbox"/>	$\varnothing$ 150	[m]	213	-	185	180	174	166	157	146	133	118	103	86	-
E10S55/7A+MAC8150	110	150	<input type="radio"/>	$\varnothing$ 150	[m]	242	-	214	207	198	188	176	164	150	135	119	100	80
E10S55/7A+MAC10150A	110	150	<input type="checkbox"/>	$\varnothing$ 150	[m]	250	-	218	212	205	197	186	173	157	140	122	103	-
E10S55/8A+MAC10180A	132	180	<input type="checkbox"/>	$\varnothing$ 150	[m]	279	254	248	241	233	223	211	196	179	161	141	119	-
E10S55/9K+MAC10180A	132	180	<input type="checkbox"/>	$\varnothing$ 150	[m]	310	277	272	265	256	244	230	214	196	176	154	131	-
E10S55/10A+MAC10200A	150	200	<input type="radio"/>	$\varnothing$ 150	[m]	349	314	308	300	290	278	263	245	225	203	178	150	-
E10S55/11A+MAC10250A	185	250	<input type="radio"/>	$\varnothing$ 150	[m]	385	-	343	332	320	306	289	270	248	223	195	165	-
E10S55/11A+MAC12230A	170	230	<input type="checkbox"/>	$\varnothing$ 150	[m]	385	352	344	335	324	310	292	271	248	223	195	165	-
E10S55/12A+MAC10250A	185	250	<input type="radio"/>	$\varnothing$ 150	[m]	419	-	375	362	348	331	312	291	267	241	212	179	-
E10S55/12A+MAC12260A	190	260	<input type="checkbox"/>	$\varnothing$ 150	[m]	420	384	376	365	352	336	318	296	271	243	213	180	-
E10S55/13A+MAC12300C	220	300	<input type="radio"/>	$\varnothing$ 150	[m]	454	-	406	394	380	363	344	321	295	267	233	194	-
E10S55/14A+MAC12300C	220	300	<input type="radio"/>	$\varnothing$ 150	[m]	489	-	436	423	406	387	365	341	314	284	249	208	-
E10S55/15A+MAC12340C	250	340	<input type="radio"/>	$\varnothing$ 150	[m]	524	-	465	453	438	419	396	369	339	304	265	218	165
NPSH					[m]	-	4,6	4,9	5,1	5,2	5,7	6,4	7	7,9	9,1	10,5	12	14

■ Without conical valve

On request

Please contact our sales organisation

For motor performances specification see page "motor features"

■ Sans soupape du clapet.

Sur demande

Contacter notre service commercial.

Pour caractéristiques techniques moteurs voir page "Caractéristiques des moteurs"

■ Senza clapet valvola di ritegno

Su richiesta

Interpellare la sede o la rete di vendita

Per caratteristiche motori vedere pagina "caratteristiche motori"

Temperature monitoring device for submersed electric motors 6" + 14": see page "Accessories"

Appareillage de contrôle de la température des moteurs électriques immergés 6" + 14": voir page "Accessories"

Apparecchiatura di controllo temperatura motori elettrici sommersi 6" + 14": vedere pagina accessori

Operating data  
 Caracteristiques de fonctionnement  
 Caratteristiche di funzionamento

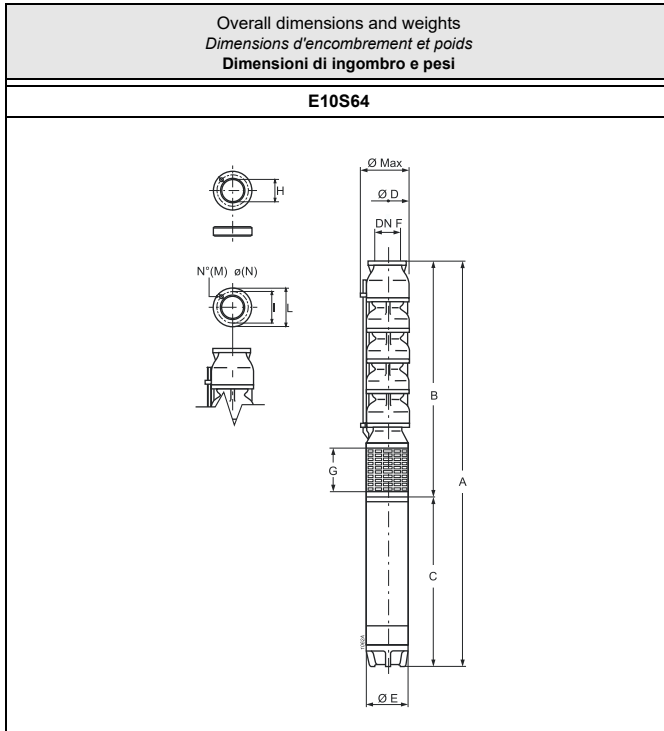

Type Type Tipo	Ø max [mm]	Weight Poids Peso [kg]	A	B	C	D	E	G	F
			[mm]						
E10S64/1H+MAC617A	250	124,5	1400	650	750	240	143	198	150
E10S64/1G+MAC620A	250	128,3	1440	650	790	240	143	198	150
E10S64/1EF+MAC625A	250	132,7	1480	650	830	240	143	198	150
E10S64/1CD+MAC630A	250	143	1570	650	920	240	143	198	150
E10S64/1BC+MAC635A	250	157,8	1705	650	1055	240	143	198	150
E10S64/1A+MAC640A	250	170,4	1815	650	1165	240	143	198	150
E10S64/1A+MAC840	250	209,5	1735,5	675,5	1060	240	191	198	150
E10S64/2EF+MAC650B	250	208	2097	815	1282	240	143	198	150
E10S64/2CD+MAC660B	250	212,3	2137	815	1322	240	143	198	150
E10S64/2EF+MAC850	250	242	1955,5	840,5	1115	240	191	198	150
E10S64/2CD+MAC860	250	259	2035,5	840,5	1195	240	191	198	150
E10S64/2BC+MAC870	250	279	2130,5	840,5	1290	240	191	198	150
E10S64/2A+MAC880	250	297	2235,5	840,5	1395	240	191	198	150
E10S64/3D+MAC890	250	326,5	2435,5	1005,5	1430	240	191	198	150
E10S64/3C+MAC8100	250	342,5	2505,5	1005,5	1500	240	191	198	150
E10S64/3A+MAC8125	250	372,5	2690,5	1005,5	1685	240	191	198	150
E10S64/3C+MAC10100A	250	407,5	2411,5	1005,5	1406	240	242	198	150
E10S64/3A+MAC10125A	250	445,5	2541,5	1005,5	1536	240	242	198	150
E10S64/4B+MAC8150	250	411	2930,5	1170,5	1760	240	191	198	150
E10S64/4B+MAC10150A	250	501	2811,5	1170,5	1641	240	242	198	150
E10S64/4A+MAC10180A	250	536	2936,5	1170,5	1766	240	242	198	150
E10S64/5BC+MAC10180A	250	556,5	3101,5	1335,5	1766	240	242	198	150
E10S64/5K+MAC10200A	250	568	3201,5	1335,5	1866	240	242	198	150

Holes Trous Fori		I	L	Counterflange Contrebride Controflangia
M	N			H
N°		Ø [mm]		
6	16	206	234	170.5

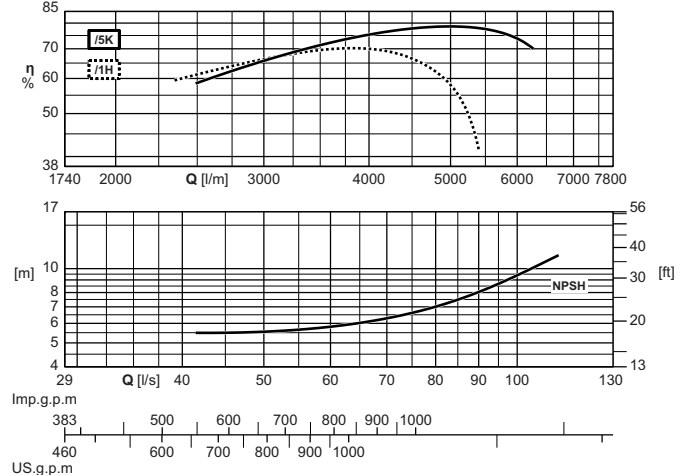
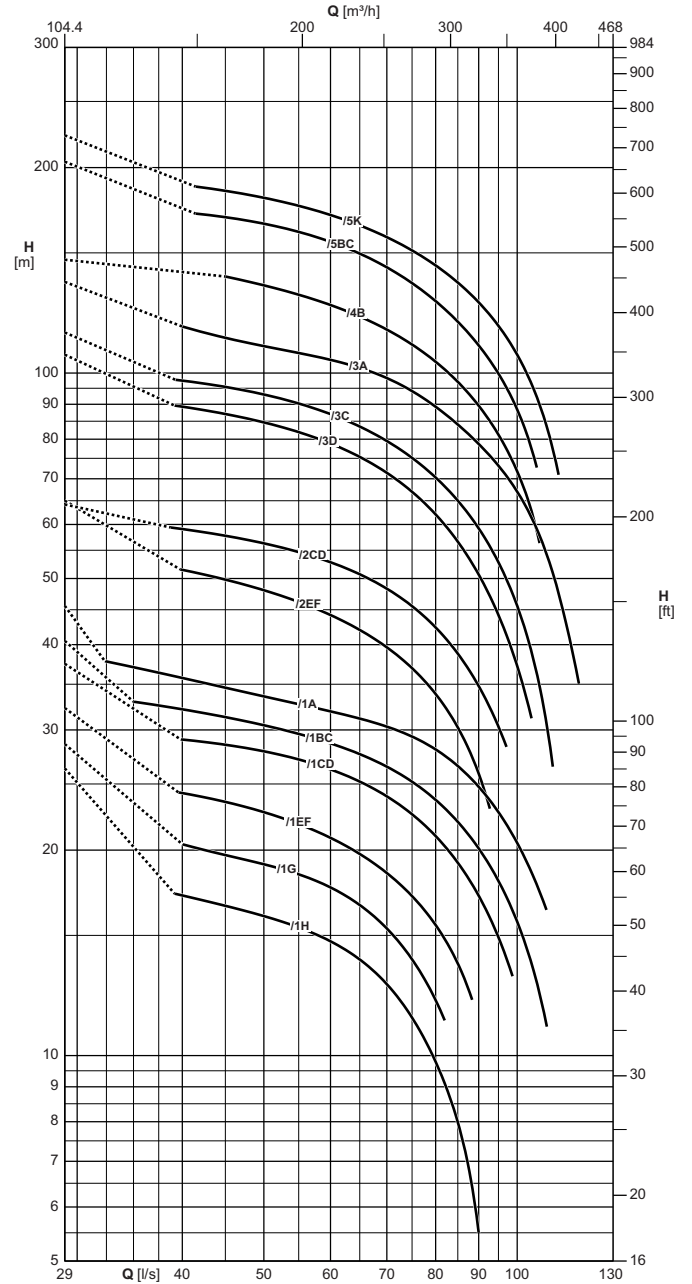

Pumps is equipped with gasket, counterflange and bolts.  
 The hydraulic performance characteristics are guaranteed as conforming to standard UNI/ISO 9906 Grade 3B.

La pompe est équipée avec garniture, contrebride et boulons.  
 Les caractéristiques hydrauliques de fonctionnement sont garanties conformes à la norme UNI/ISO 9906 Niveau 3B.

La pompa è corredata di guarnizione, controflangia e bulloni  
 Le caratteristiche di funzionamento vengono garantite secondo la norma: UNI/ISO 9906 Grado 3B.

Electric pump type Electropompe type Elettropompa tipo	Motor power Puisse. moteur Potenza motore		Horizontal installation Installation horizontale Installazione orizzontale	Check valve $\emptyset$ Clapet de retenue $\emptyset$ Valvola di ritegno $\emptyset$	Capacity Debit Portata																
	[kW]	[HP]			[l/s]	0	35	40	45	50	55	60	65	70	75	80	85	90	95	100	110
					[l/min]	0	2100	2400	2700	3000	3300	3600	3900	4200	4500	4800	5100	5400	5700	6000	6600
					[m <sup>3</sup> /h]	0	126	144	162	180	198	216	234	252	270	288	306	324	342	360	396
		Head Hauteur Prevalenza																			
E10S64/1H+MAC617A	13	17,5	<input type="checkbox"/>	$\emptyset$ 150	[m]	26,5	-	17	16,5	16	15,5	14,5	14	12,5	11,5	9,8	8	5,5	-	-	-
E10S64/1G+MAC620A	15	20	<input type="checkbox"/>	$\emptyset$ 150	[m]	28,5	-	20,5	19,5	19	18,5	17,5	16,5	15,5	14	12	-	-	-	-	-
E10S64/1EF+MAC625A	18,5	25	<input type="checkbox"/>	$\emptyset$ 150	[m]	32,5	-	24	23,5	22,5	22	21	19,5	18,5	17	15,5	13,5	-	-	-	-
E10S64/1CD+MAC630A	22	30	<input type="checkbox"/>	$\emptyset$ 150	[m]	37,5	-	29	28,5	28	27	26	25	24	22,5	21	19	17	15	-	-
E10S64/1BC+MAC635A	26	35	<input type="checkbox"/>	$\emptyset$ 150	[m]	40,5	33	32	31,5	30,5	29,5	28,5	27,5	26,5	25	23,5	22	20	18	15,5	-
E10S64/1A+MAC640A	30	40	<input type="radio"/>	$\emptyset$ 150	[m]	45,5	37	36	34,5	33,5	32,5	32	31	30,5	29,5	28	26,5	24,5	22,5	20,5	-
E10S64/1A+MAC840	30	40	<input type="checkbox"/>	$\emptyset$ 150	[m]	46,5	-	36,5	35,5	34	33,5	32,5	32	31	30	28,5	27	25	23,5	21,5	-
E10S64/2EF+MAC650B	37	50	<input type="radio"/>	$\emptyset$ 150	[m]	65	-	51	50	48	46	44	42	39,5	37	34	30	26	-	-	-
E10S64/2CD+MAC660B	45	60	<input type="radio"/>	$\emptyset$ 150	[m]	64	-	59	58	56	55	53	51	48,5	45,5	42,5	39	35	30,5	-	-
E10S64/2EF+MAC850	37	50	<input type="checkbox"/>	$\emptyset$ 150	[m]	65	-	51	50	48	46	44	42	39,5	37	34	30	26	-	-	-
E10S64/2CD+MAC860	45	60	<input type="checkbox"/>	$\emptyset$ 150	[m]	75	-	60	59	58	56	54	52	49,5	47	44	40,5	36,5	32	-	-
E10S64/2BC+MAC870	51	70	<input type="checkbox"/>	$\emptyset$ 150	[m]	81	-	65	64	63	61	59	57	55	52	49	45,5	42	38	33	-
E10S64/2A+MAC880	59	80	<input type="checkbox"/>	$\emptyset$ 150	[m]	90	-	73	70	69	67	66	64	62	60	57	53	49,5	45,5	41	-
E10S64/3D+MAC890	66	90	<input type="checkbox"/>	$\emptyset$ 150	[m]	106	-	89	87	85	82	79	75	71	67	62	57	51	44	37	-
E10S64/3C+MAC8100	75	100	<input type="radio"/>	$\emptyset$ 150	[m]	115	-	97	95	93	90	87	83	79	75	70	65	59	53	45,5	27
E10S64/3A+MAC8125	92	125	<input type="radio"/>	$\emptyset$ 150	[m]	136	-	117	113	109	107	104	102	98	94	89	84	79	73	67	51
E10S64/3C+MAC10100A	75	100	<input type="checkbox"/>	$\emptyset$ 150	[m]	116	-	98	97	96	93	90	86	82	77	72	67	62	56	48,5	30
E10S64/3A+MAC10125A	92	125	<input type="checkbox"/>	$\emptyset$ 150	[m]	136	-	117	113	109	107	104	102	98	94	89	84	79	73	67	51
E10S64/4B+MAC8150	110	150	<input type="radio"/>	$\emptyset$ 150	[m]	146	-	-	138	134	130	126	121	116	110	104	97	89	81	72	-
E10S64/4B+MAC10150A	110	150	<input type="checkbox"/>	$\emptyset$ 150	[m]	172	-	-	142	139	136	131	126	121	115	109	102	95	88	79	55
E10S64/4A+MAC10180A	132	180	<input type="checkbox"/>	$\emptyset$ 150	[m]	182	-	154	150	147	143	140	136	131	125	119	113	105	98	89	70
E10S64/5BC+MAC10180A	132	180	<input type="checkbox"/>	$\emptyset$ 150	[m]	204	-	-	169	165	161	155	150	143	135	127	119	110	100	88	-
E10S64/5K+MAC10200A	150	200	<input type="radio"/>	$\emptyset$ 150	[m]	223	-	-	185	180	176	170	164	158	151	144	135	127	117	106	78
NPSH					[m]	-	5,5	5,4	5,5	5,6	5,7	5,8	6	6,2	6,6	7	7,5	8,2	8,6	9,4	11

■ Without conical valve

On request

Please contact our sales organisation

For motor performances specification see page "motor features"

Temperature monitoring device for submersed electric motors 6" + 14": see page "Accessories"

■ Sans soupape du clapet.

Sur demande

Contacter notre service commercial.

Pour caracteristiques techniques moteurs voir page "Caracteristiques des moteurs"

Appareillage de contrôle de la température des moteurs électriques immergés 6" + 14": voir page "Accessories"

■ Senza clapet valvola di ritegno

Su richiesta

Interpellare la sede o la rete di vendita

Per caratteristiche motori vedere pagina "caratteristiche motori"

Apparecchiatura di controllo temperatura motori elettrici sommersi 6" + 14": vedere pagina accessori

Operating data  
Caracteristiques de fonctionnement  
Caratteristiche di funzionamento

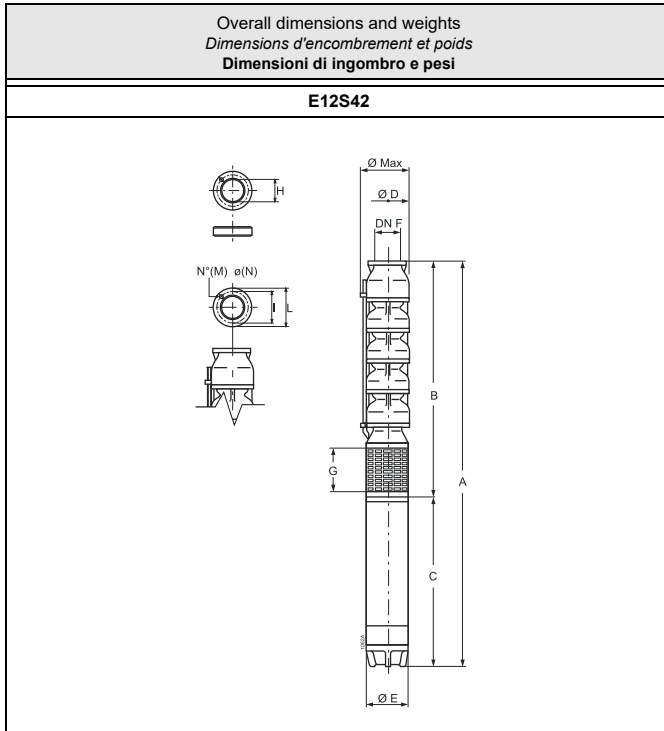

Type Type Tipo	Ø max	Weight Poids Peso	A	B	C	D	E	G	F
	[mm]								
E12S42/4A+MAC10250A	265	742	3571,5	1445,5	2126	240	242	198	150
E12S42/4A+MAC12230A	298	934	3378	1420	1958	290	290	262	200
E12S42/5MN+MAC12260A	298	1039	3708	1600	2108	290	290	262	200
E12S42/5A+MAC12300C	298	971	3558	1600	1958	290	290	262	200
E12S42/5A+M14300	340	1092	3527	1600	1927	290	337	262	200
E12S42/6B+MAC12340C	298	1075,5	3888	1780	2108	290	290	262	200
E12S42/6P+MAC12340C	298	1075,5	3888	1780	2108	290	290	262	200
E12S42/6A+MAC12340C	298	1075,5	3888	1780	2108	290	290	262	200
E12S42/6P+M14330	340	1158,5	3762	1780	1982	290	337	262	200
E12S42/6B+M14330	340	1158,5	3762	1780	1982	290	337	262	200
E12S42/6A+M14380	340	1197,5	3822	1780	2042	290	337	262	200
E12S42/7M+MAC12400C	298	1165	4218	1960	2258	290	290	262	200
E12S42/7A+MAC12400C	298	1165	4218	1960	2258	290	290	262	200
E12S42/7M+M14380	340	1234	4002	1960	2042	290	337	262	200
E12S42/7A+M14430	340	1328	4152	1960	2192	290	337	262	200
E12S42/8Q+MAC12475C	298	1227	4448	2140	2308	290	290	262	200
E12S42/8A+MAC12475C	298	1227	4448	2140	2308	290	290	262	200
E12S42/8Q+M14430	340	1365	4332	2140	2192	290	337	262	200
E12S42/8A+M14460	340	1426	4432	2140	2292	290	337	262	200
E12S42/9M+MAC12540C	298	1284	4678	2320	2358	290	290	262	200
E12S42/9M+M14500	340	1544	4732	2320	2412	290	337	262	200

Holes Trous Fori		I	L	Counterflange Contrebride Controflangia
M	N			H
N°		Ø [mm]		
8	18	260	288	221.5

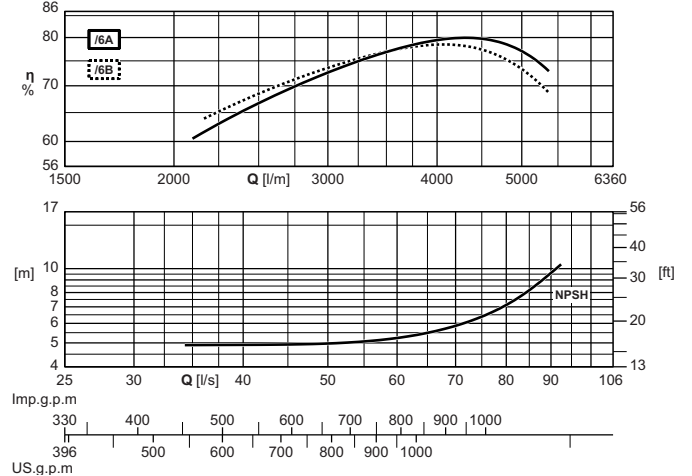
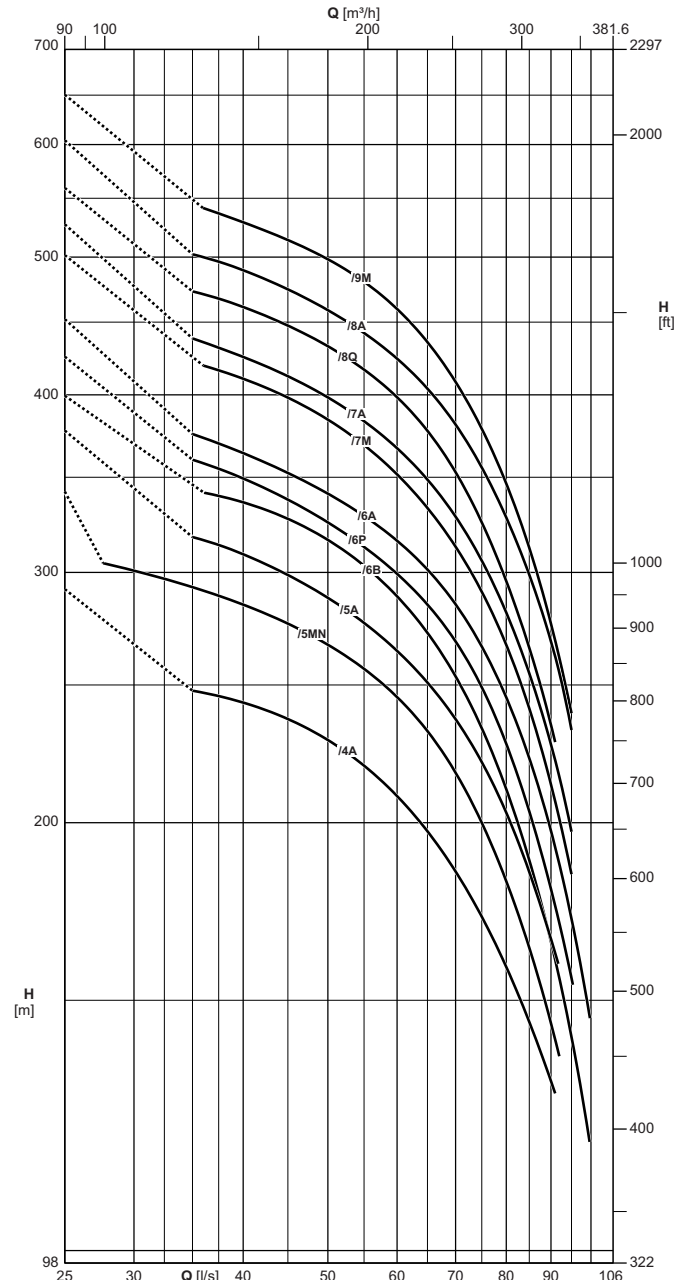

Pumps is equipped with gasket, counterflange and bolts.  
The hydraulic performance characteristics are guaranteed as conforming to standard UNI/ISO 9906 Grade 3B.

La pompe est équipée avec garniture, contrebride et boulons.  
Les caractéristiques hydrauliques de fonctionnement sont garanties conformes à la norme UNI/ISO 9906 Niveau 3B.

La pompa è corredata di guarnizione, controflangia e bulloni  
Le caratteristiche di funzionamento vengono garantite secondo la norma: UNI/ISO 9906 Grado 3B.

Electric pump type Electropompe type Elettropompa tipo	Motor power Puiss. moteur Potenza motore		Horizontal installation Installation horizontale Installazione orizzontale	Check valve $\emptyset$ Clapet de retenue $\emptyset$ Valvola di ritegno $\emptyset$	Capacity Debit Portata															
					[l/s]	0	30	35	40	45	50	55	60	65	70	75	80	85	90	95
	[l/min]	0			1800	2100	2400	2700	3000	3300	3600	3900	4200	4500	4800	5100	5400	5700		
	[m <sup>3</sup> /h]	0			108	126	144	162	180	198	216	234	252	270	288	306	324	342		
[kW]	[HP]	Head Hauteur Prevalenza																		
E12S42/4A+MAC10250A	185	250	<input type="radio"/>	$\emptyset$ 150	[m]	292	-	248	243	236	228	219	209	197	185	172	158	145	132	-
E12S42/4A+MAC12230A	170	230	<input type="checkbox"/>	$\emptyset$ 200	[m]	304	261	253	245	237	229	221	212	202	191	179	165	150	134	-
E12S42/5MN+MAC12260A	190	260	<input type="checkbox"/>	$\emptyset$ 200	[m]	342	301	293	285	276	267	257	245	232	217	200	182	163	144	-
E12S42/5A+MAC12300C	220	300	<input type="checkbox"/>	$\emptyset$ 200	[m]	377	-	318	309	299	288	276	264	251	236	220	203	185	166	-
E12S42/5A+M14300	220	300	<input type="radio"/>	$\emptyset$ 200	[m]	381	-	319	311	301	291	280	268	255	240	224	206	187	169	-
E12S42/6B+MAC12340C	250	340	<input type="radio"/>	$\emptyset$ 200	[m]	399	-	-	336	327	316	303	288	272	253	233	211	188	165	141
E12S42/6P+MAC12340C	250	340	<input type="radio"/>	$\emptyset$ 200	[m]	425	-	360	349	337	325	313	299	285	268	249	227	203	180	155
E12S42/6A+MAC12340C	250	340	<input type="radio"/>	$\emptyset$ 200	[m]	452	-	375	364	352	341	329	316	301	285	266	245	222	197	171
E12S42/6P+M14330	240	330	<input type="radio"/>	$\emptyset$ 200	[m]	419	-	-	350	339	328	316	303	286	267	247	226	205	184	160
E12S42/6B+M14330	240	330	<input type="radio"/>	$\emptyset$ 200	[m]	402	-	345	337	329	319	308	294	278	259	238	216	194	172	-
E12S42/6A+M14380	280	380	<input type="radio"/>	$\emptyset$ 200	[m]	459	-	-	369	359	348	335	321	305	288	268	247	225	203	179
E12S42/7M+MAC12400C	295	400	<input type="radio"/>	$\emptyset$ 200	[m]	502	-	-	410	398	384	369	352	333	313	291	267	241	213	184
E12S42/7A+MAC12400C	295	400	<input type="radio"/>	$\emptyset$ 200	[m]	527	-	438	425	412	398	383	367	349	328	306	281	254	227	197
E12S42/7M+M14380	280	380	<input type="radio"/>	$\emptyset$ 200	[m]	505	-	-	414	402	387	372	356	339	319	297	271	244	215	185
E12S42/7A+M14430	315	430	<input type="radio"/>	$\emptyset$ 200	[m]	533	-	-	430	418	404	390	374	355	335	312	288	263	235	206
E12S42/8Q+MAC12475C	350	475	<input type="radio"/>	$\emptyset$ 200	[m]	559	-	473	461	447	433	416	398	377	353	325	296	265	234	-
E12S42/8A+MAC12475C	350	475	<input type="radio"/>	$\emptyset$ 200	[m]	604	-	502	489	475	459	442	424	404	381	356	328	299	268	232
E12S42/8Q+M14430	315	430	<input type="radio"/>	$\emptyset$ 200	[m]	562	-	-	461	449	435	418	399	378	353	326	298	269	239	206
E12S42/8A+M14460	340	460	<input type="radio"/>	$\emptyset$ 200	[m]	604	-	-	490	477	462	446	428	407	384	358	331	302	270	235
E12S42/9M+MAC12540C	400	540	<input type="radio"/>	$\emptyset$ 200	[m]	650	-	-	529	514	498	480	459	435	408	379	347	312	276	239
E12S42/9M+M14500	370	500	<input type="radio"/>	$\emptyset$ 200	[m]	652	-	-	537	520	502	482	462	439	414	384	351	315	279	243
NPSH					[m]	-	5,2	4,9	5	5	5,1	5,1	5,3	5,6	6,1	6,4	7,1	8,3	9,6	11,5

■ Without conical valve

On request

Please contact our sales organisation

For motor performances specification see page "motor features"

Temperature monitoring device for submersed electric motors 6" + 14": see page "Accessories"

■ Sans soupape du clapet.

Sur demande

Contacter notre service commercial.

Pour caractéristiques techniques moteurs voir page "Caractéristiques des moteurs"

Appareillage de contrôle de la température des moteurs électriques immergés 6" + 14": voir page "Accessories"

■ Senza clapet valvola di ritegno

Su richiesta

Interpellare la sede o la rete di vendita

Per caratteristiche motori vedere pagina "caratteristiche motori"

Apparecchiatura di controllo temperatura motori elettrici sommersi 6" + 14": vedere pagina accessori



Operating data  
Caractéristiques de fonctionnement  
Caratteristiche di funzionamento

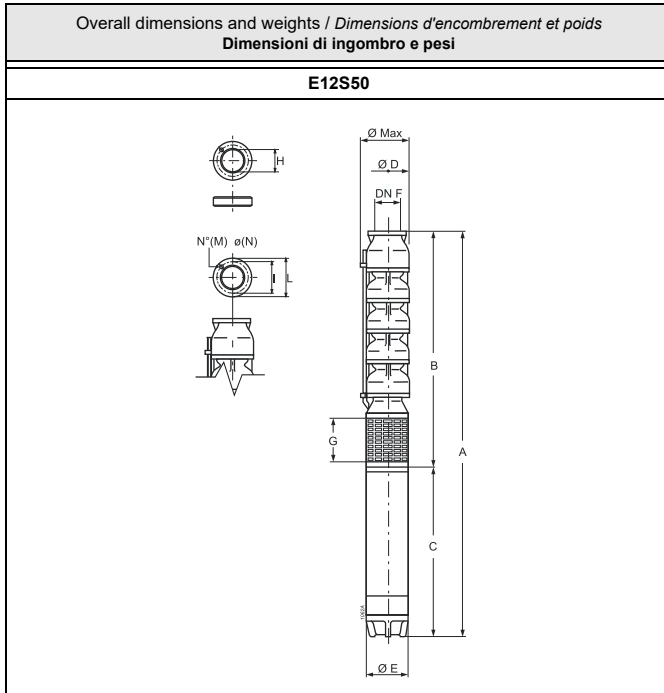

Type Type Tipo	Ø max [mm]	Weight Poids Peso [kg]	A	B	C	D	E	G	F
E12S50/1D+MAC620A	264	128,3	1447	657	790	240	143	198	150
E12S50/1B+MAC625A	264	132,7	1487	657	830	240	143	198	150
E12S50/1A+MAC630A	264	143	1577	657	920	240	143	198	150
E12S50/2EF+MAC635A	264	178,8	1887	832	1055	240	143	198	150
E12S50/2DE+MAC640A	264	191,4	1997	832	1165	240	143	198	150
E12S50/2BC+MAC650B	264	208,5	2114	832	1282	240	143	198	150
E12S50/2A+MAC660B	264	212,8	2154	832	1322	240	143	198	150
E12S50/2DE+MAC840	264	233,5	1917,5	857,5	1060	240	191	198	150
E12S50/2BC+MAC850	264	245,5	1972,5	857,5	1115	240	191	198	150
E12S50/2A+MAC860	264	262,5	2052,5	857,5	1195	240	191	198	150
E12S50/3C+MAC870	264	303,5	2322,5	1032,5	1290	240	191	198	150
E12S50/3K+MAC880	264	321,5	2427,5	1032,5	1395	240	191	198	150
E12S50/3A+MAC890	264	330,5	2462,5	1032,5	1430	240	191	198	150
E12S50/4Z+MAC8100	264	367,5	2707,5	1207,5	1500	240	191	198	150
E12S50/4A+MAC8125	264	397,5	2717,5	1032,5	1685	240	191	198	150
E12S50/4Z+MAC10100A	265	432,5	2613,5	1207,5	1406	240	242	198	150
E12S50/4A+MAC10125A	265	470,5	2743,5	1207,5	1536	240	242	198	150
E12S50/5BC+MAC8125	264	418,5	3067,5	1382,5	1685	240	191	198	150
E12S50/5A+MAC8150	264	436,5	3142,5	1382,5	1760	240	191	198	150
E12S50/5BC+MAC10125A	265	491,5	2918,5	1382,5	1536	240	242	198	150
E12S50/5A+MAC10150A	265	526,5	3023,5	1382,5	1641	240	242	198	150
E12S50/6A+MAC10180A	265	582,5	3323,5	1557,5	1766	240	242	198	150
E12S50/7I+MAC10200A	265	631,5	3598,5	1732,5	1866	240	242	198	150
E12S50/8M+MAC10220A	265	682,5	3933,5	1907,5	2026	240	242	198	150
E12S50/8A+MAC10250A	265	715,5	4059	1933	2126	240	242	198	150
E12S50/8A+MAC12230A	305	929,5	3989	2031	1958	290	290	198	150
E12S50/9A+MAC12260A	305	1018,5	4314	2206	2108	290	290	198	150
E12S50/10A+MAC12300C	305	971,5	4339	2381	1958	290	290	198	150
E12S50/10A+M14300	340	1092,5	4308	2381	1927	290	337	198	150
E12S50/11A+MAC12340C	305	1060,5	4664	2556	2108	290	290	198	150
E12S50/11A+M14330	340	1143,5	4538	2556	1982	290	337	198	150
E12S50/12A+MAC12400C	305	1134,5	4989	2731	2258	290	290	198	150
E12S50/12A+M14380	340	1203,5	4773	2731	2042	290	337	198	150

Holes / Trous Fori		I	L	Counterflange / Controflange
M	N			H
N°		Ø [mm]		
6	16	206	234	170.5

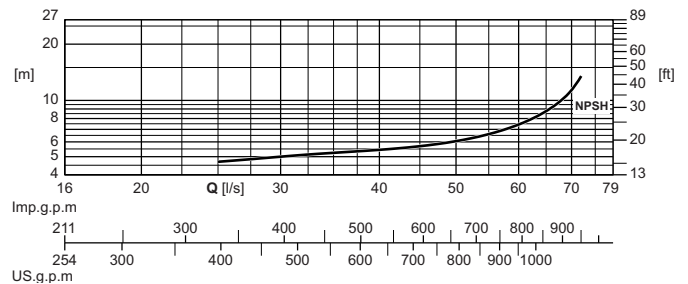
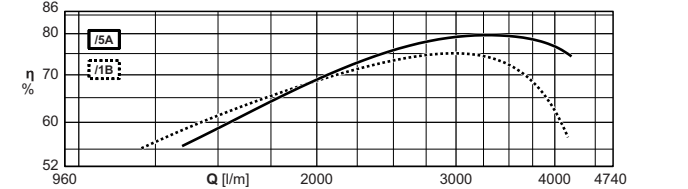
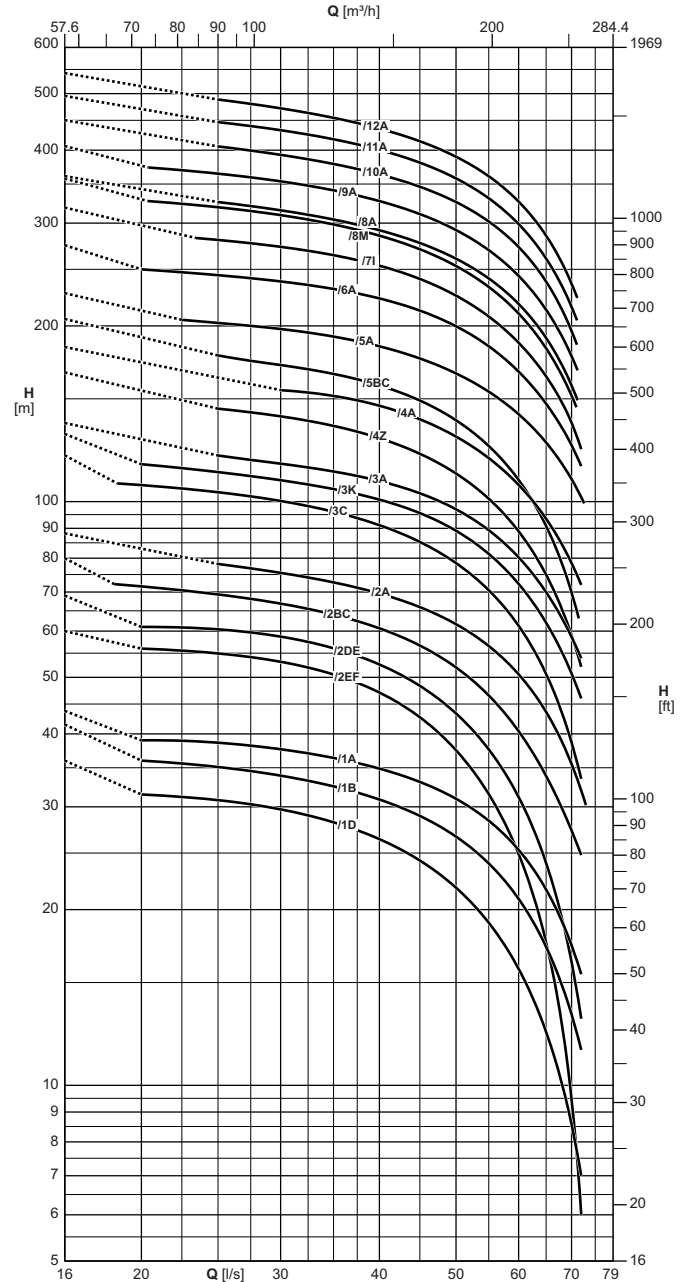

Pumps is equipped with gasket, counterflange and bolts.  
The hydraulic performance characteristics are guaranteed as conforming to standard UNI/ISO 9906 Grade 3B.

La pompe est équipée avec garniture, contrebride et boulons.  
Les caractéristiques hydrauliques de fonctionnement sont garanties conformes à la norme UNI/ISO 9906 Niveau 3B.

La pompa è corredata di guarnizione, controflangia e bulloni  
Le caratteristiche di funzionamento vengono garantite secondo la norma: UNI/ISO 9906 Grado 3B.

Operating data  
Caracteristiques de fonctionnement  
Caratteristiche di funzionamento

Electric pump type Electropompe type Elettropompa tipo	Motor power Puiss. moteur Potenza motore		Horizontal installation Installation horizontale Installazione orizzontale	Check valve $\varnothing$ Clapet de retenue $\varnothing$ Valvola di ritegno $\varnothing$	Capacity Debit Portata												
	[kW]	[HP]			[l/s]	0	20	25	30	35	40	45	50	55	60	65	70
					[l/min]	0	1200	1500	1800	2100	2400	2700	3000	3300	3600	3900	4200
					[m <sup>3</sup> /h]	0	72	90	108	126	144	162	180	198	216	234	252
Head Hauteur Prevalenza																	
E12S50/1D+MAC620A	15	20	<input type="checkbox"/>	$\varnothing$ 150	[m]	36	31,5	31	29,5	28	26,5	24,5	22	19	16	12,5	8,6
E12S50/1B+MAC625A	18,5	25	<input type="checkbox"/>	$\varnothing$ 150	[m]	41,5	36	35	34	32,5	31	29	26,5	24	21	17,5	13
E12S50/1A+MAC630A	22	30	<input type="checkbox"/>	$\varnothing$ 150	[m]	44	39	38,5	37,5	36,5	35	33	31	28,5	25,5	21,5	17,5
E12S50/2EF+MAC635A	26	35	<input type="checkbox"/>	$\varnothing$ 150	[m]	60	56	55	53	50	47	42,5	37,5	31,5	25	17,5	9,5
E12S50/2DE+MAC640A	30	40	<input type="radio"/>	$\varnothing$ 150	[m]	69	61	60	59	56	53	48,5	43,5	37,5	31	24	16,5
E12S50/2BC+MAC650B	37	50	<input type="radio"/>	$\varnothing$ 150	[m]	80	71	69	67	64	61	57	52	46,5	40,5	34	27,5
E12S50/2A+MAC660B	45	60	<input type="radio"/>	$\varnothing$ 150	[m]	88	-	78	75	73	69	66	62	57	51	43,5	35,5
E12S50/2DE+MAC840	30	40	<input type="checkbox"/>	$\varnothing$ 150	[m]	69	61	60	59	56	53	48,5	43,5	37,5	31	24	16,5
E12S50/2BC+MAC850	37	50	<input type="checkbox"/>	$\varnothing$ 150	[m]	80	73	71	69	67	64	60	55	50	43,5	36,5	29
E12S50/2A+MAC860	45	60	<input type="checkbox"/>	$\varnothing$ 150	[m]	87	80	78	76	74	72	69	65	60	53	46	37,5
E12S50/3C+MAC870	51	70	<input type="checkbox"/>	$\varnothing$ 150	[m]	120	107	104	100	96	91	85	78	70	61	51	38,5
E12S50/3K+MAC880	59	80	<input type="checkbox"/>	$\varnothing$ 150	[m]	130	116	112	109	105	101	95	89	81	72	62	51
E12S50/3A+MAC890	66	90	<input type="checkbox"/>	$\varnothing$ 150	[m]	136	-	120	116	112	108	103	97	89	80	70	59
E12S50/4Z+MAC8100	75	100	<input type="radio"/>	$\varnothing$ 150	[m]	166	-	144	140	135	128	121	111	101	89	75	59
E12S50/4A+MAC8125	92	125	<input type="radio"/>	$\varnothing$ 150	[m]	184	-	-	-	152	146	138	129	119	107	93	78
E12S50/4Z+MAC10100A	75	100	<input type="checkbox"/>	$\varnothing$ 150	[m]	168	-	-	141	136	130	123	114	103	91	77	61
E12S50/4A+MAC10125A	92	125	<input type="checkbox"/>	$\varnothing$ 150	[m]	184	-	-	158	154	148	141	133	123	111	97	83
E12S50/5BC+MAC8125	92	125	<input type="radio"/>	$\varnothing$ 150	[m]	205	-	178	171	165	158	149	138	124	109	90	70
E12S50/5A+MAC8150	110	150	<input type="radio"/>	$\varnothing$ 150	[m]	227	-	202	197	192	184	176	166	154	141	126	109
E12S50/5BC+MAC10125A	92	125	<input type="checkbox"/>	$\varnothing$ 150	[m]	210	-	179	175	170	162	153	142	129	114	96	75
E12S50/5A+MAC10150A	110	150	<input type="checkbox"/>	$\varnothing$ 150	[m]	230	-	204	199	193	186	178	167	155	140	124	105
E12S50/6A+MAC10180A	132	180	<input type="checkbox"/>	$\varnothing$ 150	[m]	275	250	244	238	231	223	212	200	184	167	147	125
E12S50/7I+MAC10200A	150	200	<input type="radio"/>	$\varnothing$ 150	[m]	319	-	281	273	264	253	240	225	207	187	164	136
E12S50/8M+MAC10220A	160	220	<input type="radio"/>	$\varnothing$ 150	[m]	358	-	319	310	298	285	271	253	233	210	183	151
E12S50/8A+MAC10250A	185	250	<input type="radio"/>	$\varnothing$ 150	[m]	361	-	326	316	304	292	277	261	241	218	190	158
E12S50/8A+MAC12230A	170	230	<input type="checkbox"/>	$\varnothing$ 150	[m]	362	-	325	315	304	291	277	260	240	217	190	158
E12S50/9A+MAC12260A	190	260	<input type="radio"/>	$\varnothing$ 150	[m]	407	-	365	354	341	327	311	292	270	243	213	177
E12S50/10A+MAC12300C	220	300	<input type="radio"/>	$\varnothing$ 150	[m]	450	-	406	393	379	364	346	326	302	273	238	196
E12S50/10A+M14300	220	300	<input type="radio"/>	$\varnothing$ 150	[m]	453	-	-	397	383	368	350	329	304	275	241	200
E12S50/11A+MAC12340C	250	340	<input type="radio"/>	$\varnothing$ 150	[m]	495	-	447	433	417	401	381	358	331	299	261	215
E12S50/11A+M14330	240	330	<input type="radio"/>	$\varnothing$ 150	[m]	498	-	-	436	422	405	385	361	334	302	264	220
E12S50/12A+MAC12400C	295	400	<input type="radio"/>	$\varnothing$ 150	[m]	542	-	488	472	454	436	414	390	361	326	285	236
E12S50/12A+M14380	280	380	<input type="radio"/>	$\varnothing$ 150	[m]	544	-	489	475	458	440	418	393	364	330	289	241
NPSH					[m]	-	4,6	4,7	5	5,1	5,2	5,4	6	6,4	7,3	8,8	11,5

■ Without conical valve

On request

Please contact our sales organisation

For motor performances specification see page "motor features"

Temperature monitoring device for submersed electric motors 6" + 14": see page "Accessories"

■ Sans soupape du clapet.

Sur demande

Contacter notre service commercial.

Pour caractéristiques techniques moteurs voir page "Caractéristiques des moteurs"

Appareillage de contrôle de la température des moteurs électriques immergés 6" + 14": voir page "Accessories"

■ Senza clapet valvola di ritegno

Su richiesta

Interpellare la sede o la rete di vendita

Per caratteristiche motori vedere pagina "caratteristiche motori"

Apparecchiatura di controllo temperatura motori elettrici sommersi 6" + 14": vedere pagina accessori

Operating data  
 Caracteristiques de fonctionnement  
 Caratteristiche di funzionamento

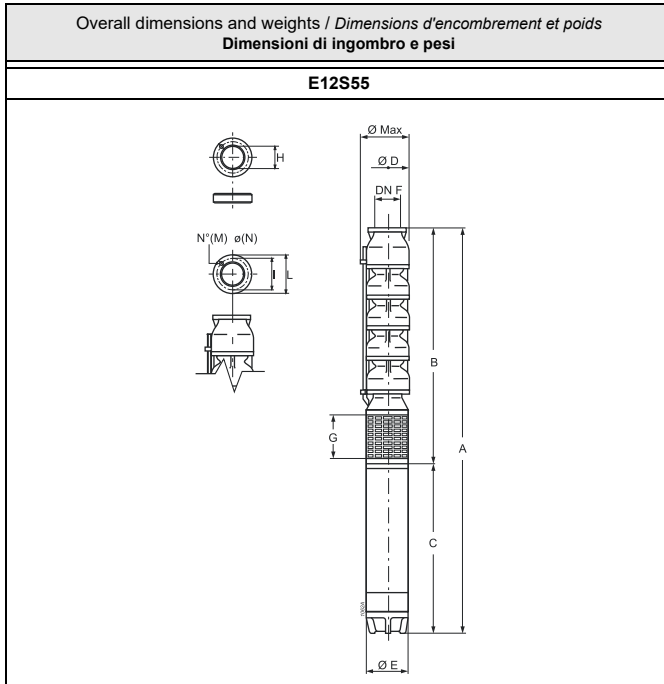

Type Type Tipo	Ø max	Weight Poids Peso	A	B	C	D	E	G	F
E12S55/1GH+MAC620A	264	128,3	1447	657	790	240	143	198	150
E12S55/1EF+MAC625A	264	132,7	1487	657	830	240	143	198	150
E12S55/1D+MAC630A	264	143	1577	657	920	240	143	198	150
E12S55/1B+MAC640A	264	170,4	1822	657	1165	240	143	198	150
E12S55/1B+MAC840	264	212,5	1742,5	682,5	1060	240	191	198	150
E12S55/2GH+MAC640A	264	191,4	1997	832	1165	240	143	198	150
E12S55/2EF+MAC650B	264	208,5	2114	832	1282	240	143	198	150
E12S55/2D+MAC660B	264	212,8	2154	832	1322	240	143	198	150
E12S55/2GH+MAC840	264	233,5	1917,5	857,5	1060	240	191	198	150
E12S55/2EF+MAC850	264	245,5	1972,5	857,5	1115	240	191	198	150
E12S55/2D+MAC860	264	262,5	2052,5	857,5	1195	240	191	198	150
E12S55/2B+MAC870	264	282,5	2147,5	857,5	1290	240	191	198	150
E12S55/2A+MAC880	264	300,5	2252,5	857,5	1395	240	191	198	150
E12S55/3DE+MAC880	264	321,5	2427,5	1032,5	1395	240	191	198	150
E12S55/3CJ+MAC890	264	330,5	2462,5	1032,5	1430	240	191	198	150
E12S55/3A+MAC8125	264	376,5	2717,5	1032,5	1685	240	191	198	150
E12S55/3A+MAC10125A	265	449,5	2568,5	1032,5	1536	240	242	198	150
E12S55/4JF+MAC8100	264	367,5	2707,5	1207,5	1500	240	191	198	150
E12S55/4D+MAC8125	264	397,5	2892,5	1207,5	1685	240	191	198	150
E12S55/4B+MAC8150	264	415,5	2967,5	1207,5	1760	240	191	198	150
E12S55/4JF+MAC10100A	265	432,5	2613,5	1207,5	1406	240	242	198	150
E12S55/4D+MAC10125A	265	470,5	2743,5	1207,5	1536	240	242	198	150
E12S55/4B+MAC10150A	265	505,5	2848,5	1207,5	1641	240	242	198	150
E12S55/5D+MAC8150	264	436,5	3142,5	1382,5	1760	240	191	198	150
E12S55/5D+MAC10150A	265	526,5	3023,5	1382,5	1641	240	242	198	150
E12S55/5T+MAC10180A	265	561	3148,5	1382,5	1766	240	242	198	150
E12S55/6BC+MAC10200A	265	610	3423,5	1557,5	1866	240	242	198	150
E12S55/6A+MAC10220A	265	640	3583,5	1557,5	2026	240	242	198	150
E12S55/7K+MAC12260A	305	976,5	3964	1856	2108	290	290	198	150
E12S55/8A+MAC12300C	305	929,5	3989	2031	1958	290	290	198	150
E12S55/8A+M14300	340	1050,5	3958	2031	1927	290	337	198	150
E12S55/9B+MAC12340C	305	1018,5	4314	2206	2108	290	290	198	150
E12S55/9Q+MAC12340C	340	1018,5	4314	2206	2108	290	290	198	150
E12S55/9Q+M14330	340	1101,5	4188	2206	1982	290	337	198	150
E12S55/9B+M14330	340	1101,5	4188	2206	1982	290	337	198	150
E12S55/10A+MAC12400C	340	1092,5	4639	2381	2258	290	290	198	150
E12S55/10A+M14380	340	1161,5	4423	2381	2042	290	337	198	150

Holes Trous Fori		I	L	Counterflange Contrebride Controflangia
M	N			H
N°		Ø [mm]		
6	16	206	234	170.5

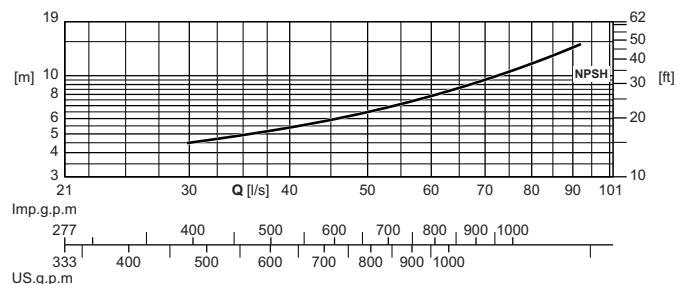
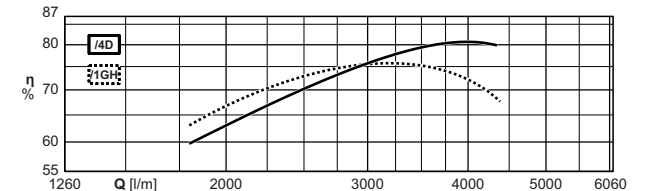
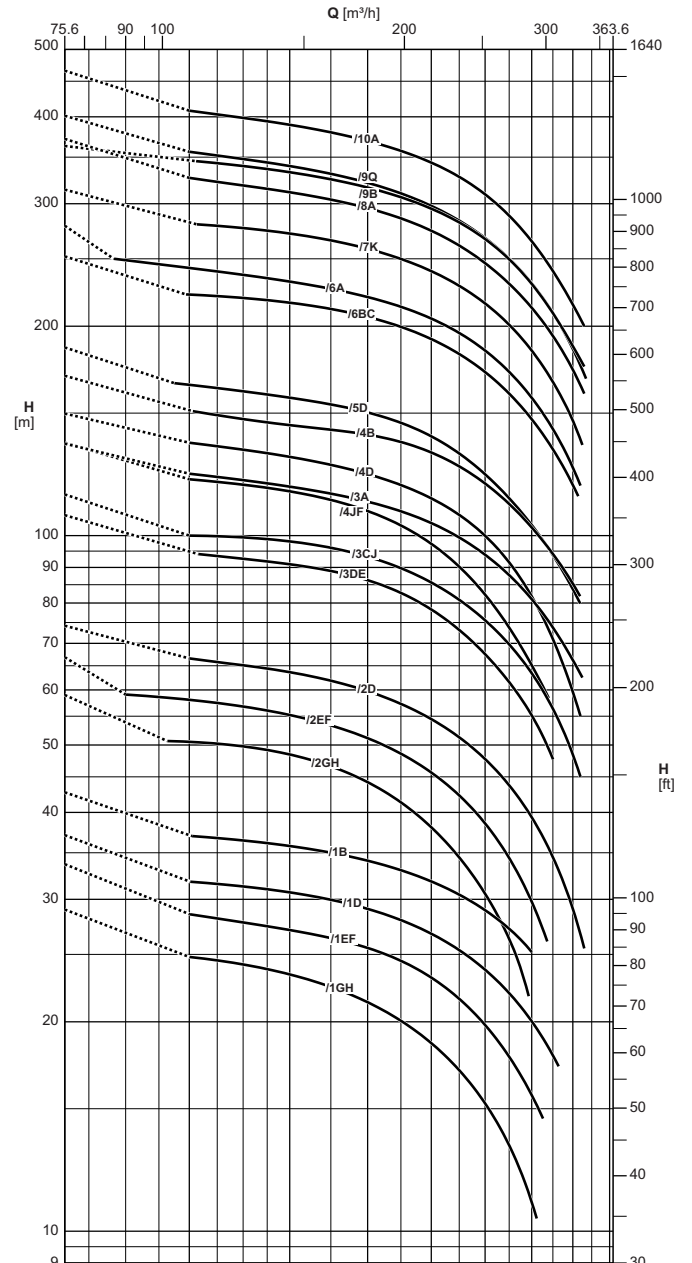

Pumps is equipped with gasket, counterflange and bolts.  
 The hydraulic performance characteristics are guaranteed as conforming to standard UNI/ISO 9906 Grade 3B.

La pompe est équipée avec garniture, contrebride et boulons.  
 Les caractéristiques hydrauliques de fonctionnement sont garanties conformes à la norme UNI/ISO 9906 Niveau 3B.

La pompa è corredata di guarnizione, controflangia e bulloni  
 Le caratteristiche di funzionamento vengono garantite secondo la norma: UNI/ISO 9906 Grado 3B.

Operating data  
Caracteristiques de fonctionnement  
Caratteristiche di funzionamento

Electric pump type Electropompe type Elettropompa tipo	Motor power Puisse. moteur Potenza motore		Horizontal installation Installation horizontale Installazione orizzontale	Check valve Ø Clapet de retenue Ø Valvola di ritegno Ø	Capacity Debit Portata																
	[kW]	[HP]			Head Hauteur Prevalenza																
					[l/s]	0	30	35	40	45	50	55	60	65	70	75	80	85	90		
					[l/min]	0	1800	2100	2400	2700	3000	3300	3600	3900	4200	4500	4800	5100	5400		
[m³/h]	0	108	126	144	162	180	198	216	234	252	270	288	306	324							
E12S55/1GH+MAC620A	15	20	<input type="checkbox"/>	Ø 150	[m]	29	25	24	23,5	22,5	21,5	20	18,5	17	15,5	13,5	11	-	-		
E12S55/1EF+MAC625A	18,5	25	<input type="checkbox"/>	Ø 150	[m]	33,5	-	28	27	26,5	25,5	24,5	23	21,5	20	18	15,5	-	-		
E12S55/1D+MAC630A	22	30	<input type="checkbox"/>	Ø 150	[m]	37	-	31,5	30,5	30	29	28	27	25,5	24	22	20	18	-		
E12S55/1B+MAC640A	30	40	<input type="radio"/>	Ø 150	[m]	43	-	36,5	36	35	34	33	32	30,5	29	27	25	-	-		
E12S55/1B+MAC840	30	40	<input type="checkbox"/>	Ø 150	[m]	43	-	37	36,5	35,5	34,5	33,5	32,5	31	29,5	27,5	26	24	22		
E12S55/2GH+MAC640A	30	40	<input type="radio"/>	Ø 150	[m]	59	50	50	48,5	46,5	44	41,5	38	34,5	30,5	26	-	-	-		
E12S55/2EF+MAC650B	37	50	<input type="radio"/>	Ø 150	[m]	67	58	57	55	53	51	48,5	45,5	42,5	38,5	34,5	30	-	-		
E12S55/2D+MAC660B	45	60	<input type="radio"/>	Ø 150	[m]	74	66	65	64	62	60	57	54	51	47,5	43,5	39,5	34,5	29		
E12S55/2GH+MAC840	30	40	<input type="checkbox"/>	Ø 150	[m]	59	50	50	48,5	46,5	44	41,5	38	34,5	30,5	26	-	-	-		
E12S55/2EF+MAC850	37	50	<input type="checkbox"/>	Ø 150	[m]	67	59	58	57	55	53	51	48	44,5	41	36,5	32,5	-	-		
E12S55/2D+MAC860	45	60	<input type="checkbox"/>	Ø 150	[m]	75	65	65	64	63	61	59	56	53	49,5	45,5	41,5	37	32		
E12S55/2B+MAC870	51	70	<input type="checkbox"/>	Ø 150	[m]	87	76	75	73	71	69	66	63	60	57	53	48,5	43,5	38,5		
E12S55/2A+MAC880	59	80	<input type="checkbox"/>	Ø 150	[m]	89	80	78	76	74	72	70	67	64	60	56	51	46,5	41,5		
E12S55/3DE+MAC880	59	80	<input type="checkbox"/>	Ø 150	[m]	107	-	92	91	89	86	83	78	73	67	62	55	47,5	-		
E12S55/3CJ+MAC890	66	90	<input type="checkbox"/>	Ø 150	[m]	114	100	99	98	96	93	90	85	81	75	70	63	56	48,5		
E12S55/3A+MAC8125	92	125	<input type="radio"/>	Ø 150	[m]	135	123	120	117	115	112	108	104	99	94	88	81	74	66		
E12S55/3A+MAC10125A	92	125	<input type="checkbox"/>	Ø 150	[m]	135	123	120	117	115	112	108	104	99	94	88	81	74	66		
E12S55/4JF+MAC8100	75	100	<input type="radio"/>	Ø 150	[m]	136	120	118	116	112	108	103	97	90	82	74	65	-	-		
E12S55/4D+MAC8125	92	125	<input type="radio"/>	Ø 150	[m]	150	136	133	130	126	122	118	113	107	100	91	82	71	60		
E12S55/4B+MAC8150	110	150	<input type="radio"/>	Ø 150	[m]	170	-	147	144	142	139	136	132	126	119	111	103	94	85		
E12S55/4JF+MAC10100A	75	100	<input type="checkbox"/>	Ø 150	[m]	137	-	120	117	114	110	105	100	93	85	76	67	59	-		
E12S55/4D+MAC10125A	92	125	<input type="checkbox"/>	Ø 150	[m]	151	133	133	131	129	125	121	115	109	102	94	86	76	66		
E12S55/4B+MAC10150A	110	150	<input type="checkbox"/>	Ø 150	[m]	173	154	152	150	147	143	138	132	126	119	111	102	93	84		
E12S55/5D+MAC8150	110	150	<input type="radio"/>	Ø 150	[m]	186	165	161	158	154	150	145	139	131	122	113	103	94	84		
E12S55/5D+MAC10150A	110	150	<input type="checkbox"/>	Ø 150	[m]	190	168	167	165	162	157	152	145	137	128	119	108	97	83		
E12S55/5T+MAC10180A	132	180	<input type="checkbox"/>	Ø 150	[m]	208	-	182	179	176	172	168	162	154	146	137	127	116	105		
E12S55/6BC+MAC10200A	150	200	<input type="radio"/>	Ø 150	[m]	252	222	219	216	212	206	199	191	182	172	160	147	133	118		
E12S55/6A+MAC10220A	160	220	<input type="radio"/>	Ø 150	[m]	279	242	237	232	226	220	213	205	195	184	172	158	142	125		
E12S55/7K+MAC12260A	190	260	<input type="radio"/>	Ø 150	[m]	314	-	277	272	266	258	250	240	228	215	201	184	166	146		
E12S55/8A+MAC12300C	220	300	<input type="radio"/>	Ø 150	[m]	372	327	319	311	304	296	286	274	261	246	230	212	194	173		
E12S55/8A+M14300	220	300	<input type="radio"/>	Ø 150	[m]	374	328	320	313	306	298	288	277	265	250	233	215	196	176		
E12S55/9B+MAC12340C	250	340	<input type="radio"/>	Ø 150	[m]	363	-	340	333	325	316	306	295	282	267	249	230	209	187		
E12S55/9Q+MAC12340C	250	340	<input type="radio"/>	Ø 150	[m]	401	356	348	340	331	321	310	298	284	268	250	230	209	185		
E12S55/9Q+M14330	240	330	<input type="radio"/>	Ø 150	[m]	399	356	349	343	335	327	317	305	291	274	255	234	214	192		
E12S55/9B+M14330	240	330	<input type="radio"/>	Ø 150	[m]	366	-	345	339	331	322	311	299	286	270	252	233	212	191		
E12S55/10A+MAC12400C	295	400	<input type="radio"/>	Ø 150	[m]	466	408	399	389	380	369	357	344	328	309	288	265	240	215		
E12S55/10A+M14380	280	380	<input type="radio"/>	Ø 150	[m]	468	408	401	393	383	372	359	345	329	310	289	266	242	217		
NPSH					[m]	-	3,8	4,9	5,4	5,9	6,5	7,2	7,9	8,7	9	10,5	11,5	13	13,5		

■ Without conical valve

On request

Please contact our sales organisation

For motor performances specification see page "motor features"

Temperature monitoring device for submersed electric motors 6" + 14": see page "Accessories"

■ Sans soupape du clapet.

Sur demande

Contacter notre service commercial.

Pour caractéristiques techniques moteurs voir page "Caractéristiques des moteurs"

Appareillage de contrôle de la température des moteurs électriques immergés 6" + 14": voir page "Accessories"

■ Senza clapet valvola di ritegno

Su richiesta

Interpellare la sede o la rete di vendita

Per caratteristiche motori vedere pagina "caratteristiche motori"

Apparecchiatura di controllo temperatura motori elettrici sommersi 6" + 14": vedere pagina accessori

Operating data  
 Caracteristiques de fonctionnement  
 Caratteristiche di funzionamento

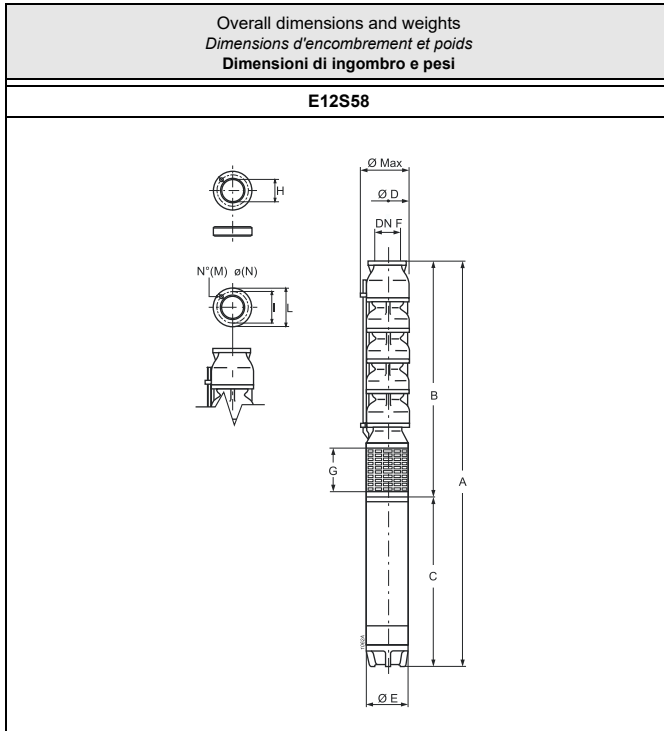

Type Type Tipo	Ø max [mm]	Weight Poids Peso [kg]	A	B	C	D	E	G	F
E12S58/1AB+MAC650B	264	187,5	1967,5	685,5	1282	240	143	198	150
E12S58/1AB+MAC850	264	224,5	1800,5	685,5	1115	240	191	198	150
E12S58/2BC+MAC880	264	300,5	2255,5	860,5	1395	240	191	198	150
E12S58/2AJ+MAC890	264	309,5	2290,5	860,5	1430	240	191	198	150
E12S58/2A+MAC8100	264	325,5	2360,5	860,5	1500	240	191	198	150
E12S58/2A+MAC10100A	265	390,5	2266,5	860,5	1406	240	242	198	150
E12S58/3W+MAC8125	264	376,5	2720,5	1035,5	1685	240	191	198	150
E12S58/3A+MAC8150	264	394,5	2795,5	1035,5	1760	240	191	198	150
E12S58/3W+MAC10125A	265	449,5	2571,5	1035,5	1536	240	242	198	150
E12S58/3A+MAC10150A	265	484,5	2676,5	1035,5	1641	240	242	198	150
E12S58/4M+MAC10180A	265	540,5	2976,5	1210,5	1766	240	242	198	150
E12S58/4A+MAC10200A	265	568,5	3076,5	1210,5	1866	240	242	198	150
E12S58/5M+MAC10250A	265	652,5	3511,5	1385,5	2126	240	242	198	150
E12S58/5I+MAC10250A	265	652,5	3511,5	1385,5	2126	240	242	198	150
E12S58/5M+MAC12230A	305	866,5	3464	1506	1958	290	290	198	150
E12S58/5A+MAC12260A	305	934,5	3614	1506	2108	290	290	198	150
E12S58/6Z+MAC12260A	305	955,5	3789	1681	2108	290	290	198	150
E12S58/7Z+MAC12340C	305	976,5	3964	1856	2108	290	290	198	150
E12S58/7X+MAC12340C	305	976,5	3964	1856	2108	290	290	198	150
E12S58/7A+MAC12400C	305	1029,5	4114	1856	2258	290	290	198	150
E12S58/7X+M14330	340	1059,5	3838	1856	1982	290	337	198	150
E12S58/7Z+M14330	340	1059,5	3838	1856	1982	290	337	198	150
E12S58/7A+M14380	340	1098,5	3898	1856	2042	290	337	198	150
E12S58/8AB+MAC12400C	305	1050,5	4289	2031	2258	290	290	198	150
E12S58/8AB+M14380	340	1119,5	4073	2031	2042	290	337	198	150

Holes Trous Fori		I	L	Counterflange Contrebride Controflangia
M	N			H
N°		Ø [mm]		
6	16	206	234	170.5

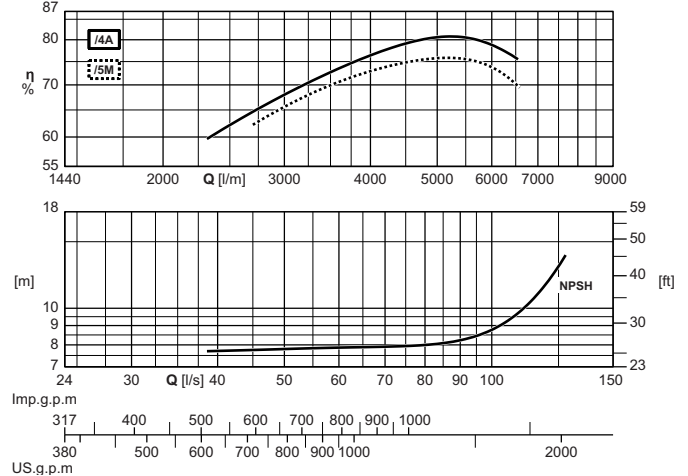
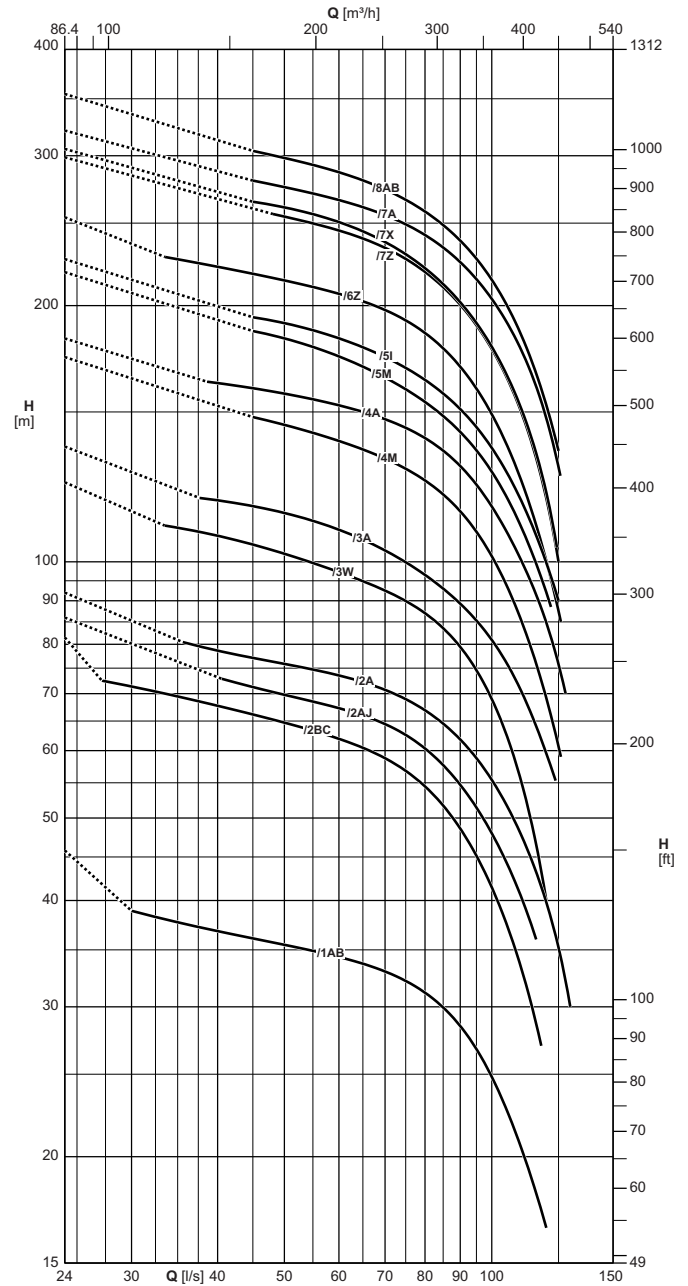

Pumps is equipped with gasket, counterflange and bolts.  
 The hydraulic performance characteristics are guaranteed as conforming to standard UNI/ISO 9906 Grade 3B.

La pompe est équipée avec garniture, contrebride et boulons.  
 Les caractéristiques hydrauliques de fonctionnement sont garanties conformes à la norme UNI/ISO 9906 Niveau 3B.

La pompa è corredata di guarnizione, controflangia e bulloni  
 Le caratteristiche di funzionamento vengono garantite secondo la norma: UNI/ISO 9906 Grado 3B.

Operating data  
Caracteristiques de fonctionnement  
Caratteristiche di funzionamento

Electric pump type Electropompe type Elettropompa tipo	Motor power Puisse. moteur Potenza motore		Horizontal installation Installation horizontale Installazione orizzontale	Check valve $\varnothing$ Clapet de retenue $\varnothing$ Valvola di ritegno $\varnothing$	Capacity Debit Portata															
	[kW]	[HP]			[l/s]	0	30	35	40	45	50	60	70	80	90	100	110	120	130	
					[l/min]	0	1800	2100	2400	2700	3000	3600	4200	4800	5400	6000	6600	7200	7800	
					[m <sup>3</sup> /h]	0	108	126	144	162	180	216	252	288	324	360	396	432	468	
Head Hauteur Prevalenza																				
		[m]	46	39	37,5	37	36	35,5	34,5	33	31	28,5	25	20,5	16,5	-	-			
E12S58/1AB+MAC650B	37	50	<input type="radio"/>	$\varnothing$ 150	[m]	46	39	37,5	37	36	35,5	34,5	33	31	28,5	25	20,5	16,5	-	
E12S58/1AB+MAC850	37	50	<input type="checkbox"/>	$\varnothing$ 150	[m]	46	39	37,5	37	36	35,5	34,5	33	31	28,5	25	20,5	16,5	-	
E12S58/2BC+MAC880	59	80	<input type="checkbox"/>	$\varnothing$ 150	[m]	81	71	69	68	66	65	62	59	54	48,5	41,5	33,5	-	-	
E12S58/2AJ+MAC890	66	90	<input type="checkbox"/>	$\varnothing$ 150	[m]	86	-	-	-	71	70	67	64	60	55	48	40,5	-	-	
E12S58/2A+MAC8100	75	100	<input type="radio"/>	$\varnothing$ 150	[m]	92	-	-	79	77	76	73	71	67	62	55	48	40	30	
E12S58/2A+MAC10100A	75	100	<input type="checkbox"/>	$\varnothing$ 150	[m]	92	-	-	80	79	77	74	70	66	61	56	49	41,5	-	
E12S58/3W+MAC8125	92	125	<input type="radio"/>	$\varnothing$ 150	[m]	124	-	109	107	105	102	97	92	87	79	69	56	40	-	
E12S58/3A+MAC8150	110	150	<input type="radio"/>	$\varnothing$ 150	[m]	136	-	-	118	116	114	109	103	96	89	81	71	60	-	
E12S58/3W+MAC10125A	92	125	<input type="checkbox"/>	$\varnothing$ 150	[m]	124	-	109	107	105	102	97	92	87	79	69	56	40	-	
E12S58/3A+MAC10150A	110	150	<input type="checkbox"/>	$\varnothing$ 150	[m]	137	-	-	121	119	117	113	109	103	96	87	76	63	-	
E12S58/4M+MAC10180A	132	180	<input type="checkbox"/>	$\varnothing$ 150	[m]	174	-	-	-	148	145	139	132	124	114	101	86	69	-	
E12S58/4A+MAC10200A	150	200	<input type="radio"/>	$\varnothing$ 150	[m]	183	-	-	162	160	157	153	147	140	129	116	101	85	-	
E12S58/5M+MAC10250A	185	250	<input type="radio"/>	$\varnothing$ 150	[m]	219	-	-	-	187	183	174	164	154	142	127	110	92	-	
E12S58/5I+MAC10250A	185	250	<input type="radio"/>	$\varnothing$ 150	[m]	227	-	-	-	194	191	183	174	163	151	136	118	100	-	
E12S58/5M+MAC12230A	170	230	<input type="checkbox"/>	$\varnothing$ 150	[m]	220	-	-	193	189	186	179	171	161	149	133	114	95	-	
E12S58/5A+MAC12260A	190	260	<input type="checkbox"/>	$\varnothing$ 150	[m]	230	-	-	204	201	198	192	185	176	163	147	128	107	-	
E12S58/6Z+MAC12260A	190	260	<input type="checkbox"/>	$\varnothing$ 150	[m]	254	-	227	222	218	214	206	197	185	169	149	125	100	-	
E12S58/7Z+MAC12340C	250	340	<input type="radio"/>	$\varnothing$ 150	[m]	299	-	-	-	-	254	245	234	219	200	178	151	119	-	
E12S58/7X+MAC12340C	250	340	<input type="radio"/>	$\varnothing$ 150	[m]	306	-	-	-	265	261	250	237	221	202	179	152	121	-	
E12S58/7A+MAC12400C	295	400	<input type="radio"/>	$\varnothing$ 150	[m]	321	-	-	-	280	276	266	255	242	225	204	178	147	-	
E12S58/7X+M14330	240	330	<input type="radio"/>	$\varnothing$ 150	[m]	307	-	-	271	268	264	254	241	226	206	182	155	124	-	
E12S58/7Z+M14330	240	330	<input type="radio"/>	$\varnothing$ 150	[m]	300	-	-	-	-	255	246	236	223	204	181	153	121	-	
E12S58/7A+M14380	280	380	<input type="radio"/>	$\varnothing$ 150	[m]	322	-	-	286	281	276	267	257	245	229	207	181	152	-	
E12S58/8AB+MAC12400C	295	400	<input type="radio"/>	$\varnothing$ 150	[m]	355	-	-	-	304	298	287	274	258	238	214	186	153	-	
E12S58/8AB+M14380	280	380	<input type="radio"/>	$\varnothing$ 150	[m]	356	-	-	-	-	300	289	277	261	241	216	187	154	-	
NPSH					[m]	-	7,7	7,7	7,8	7,8	7,8	7,9	7,8	8	8,6	9	9,8	11,5	14,5	

■ Without conical valve

On request

Please contact our sales organisation

For motor performances specification see page "motor features"

Temperature monitoring device for submersed electric motors 6" + 14": see page "Accessories"

■ Sans soupape du clapet.

Sur demande

Contacter notre service commercial.

Pour caracteristiques techniques moteurs voir page "Caracteristiques des moteurs"

Appareillage de contrôle de la température des moteurs électriques immergés 6" + 14": voir page "Accessories"

■ Senza clapet valvola di ritegno

Su richiesta

Interpellare la sede o la rete di vendita

Per caratteristiche motori vedere pagina "caratteristiche motori"

Apparecchiatura di controllo temperatura motori elettrici sommersi 6" + 14": vedere pagina accessori

Operating data  
Caracteristiques de fonctionnement  
Caratteristiche di funzionamento

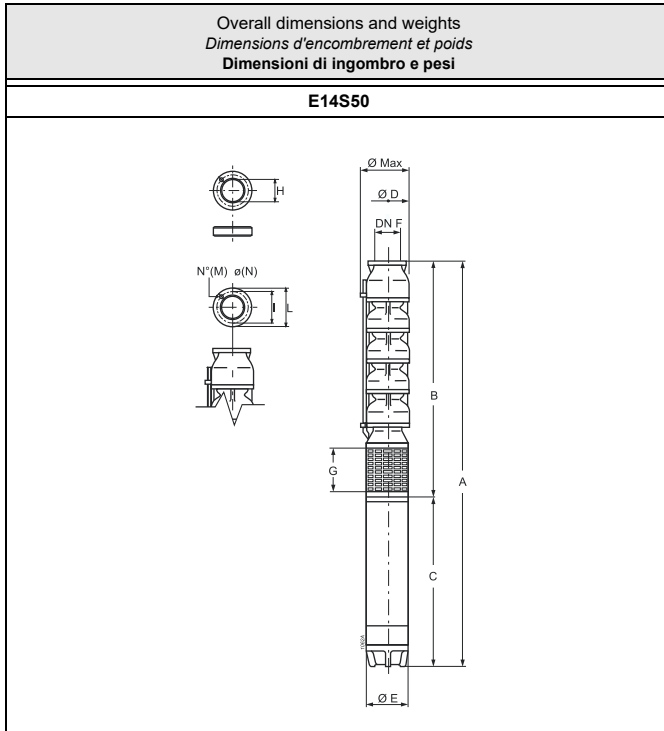

Type Type Tipo	Ø max [mm]	Weight Poids Peso [kg]	A	B	C	D	E	G	F
E14S50/1E+MAC840	342	310	2170,5	1110,5	1060	290	191	262	200
E14S50/1D+MAC850	342	322	2225,5	1110,5	1115	290	191	262	200
E14S50/1C+MAC860	342	339	2305,5	1110,5	1195	290	191	262	200
E14S50/1B+MAC870	342	359	2400,5	1110,5	1290	290	191	262	200
E14S50/1A+MAC880	342	377	2505,5	1110,5	1395	290	191	262	200
E14S50/2E+MAC880	342	416,5	2710,5	1315,5	1395	290	191	262	200
E14S50/2D+MAC890	342	425,5	2745,5	1315,5	1430	290	191	262	200
E14S50/2CD+MAC8100	342	441,5	2815,5	1315,5	1500	290	191	262	200
E14S50/2BC+MAC8125	342	471,5	3000,5	1315,5	1685	290	191	262	200
E14S50/2AB+MAC8150	342	489,5	3075,5	1315,5	1760	290	191	262	200
E14S50/2CD+MAC10100A	342	506,5	2721,5	1315,5	1406	290	242	262	200
E14S50/2BC+MAC10125A	342	544,5	2851,5	1315,5	1536	290	242	262	200
E14S50/2AB+MAC10150A	342	579,5	2956,5	1315,5	1641	290	242	262	200
E14S50/3C+MAC10180A	342	654	3286,5	1520,5	1766	290	242	262	200
E14S50/3B+MAC10200A	342	682	3386,5	1520,5	1866	290	242	262	200
E14S50/3A+MAC10250A	342	745	3646,5	1520,5	2126	290	242	262	200
E14S50/3A+MAC12230A	342	951	3453	1495	1958	290	290	262	200
E14S50/4BC+MAC10250A	342	499	3851,5	1725,5	2126	290	242	262	200
E14S50/4BC+MAC12260A	342	1058,5	3808	1700	2108	290	290	262	200
E14S50/4I+MAC12300C	342	990,5	3658	1700	1958	290	290	262	200
E14S50/4I+M14300	342	1111,5	3627	1700	1927	290	337	262	200
E14S50/5JC+MAC12340C	342	1098	4013	1905	2108	290	290	262	200
E14S50/5I+MAC12400C	342	1151	4163	1905	2258	290	290	262	200
E14S50/5JC+M14330	342	1181	3887	1905	1982	290	337	262	200
E14S50/5I+M14380	342	1220	3947	1905	2042	290	337	262	200
E14S50/6W+MAC12475C	342	1215,5	4418	2110	2308	290	290	262	200
E14S50/6I+MAC12475C	342	1215,5	4418	2110	2308	290	290	262	200
E14S50/6W+M14430	342	1353,5	4302	2110	2192	290	337	262	200
E14S50/6I+M14460	342	1414,5	4402	2110	2292	290	337	262	200
E14S50/7Q+MAC12540C	342	1276	4673	2315	2358	290	290	262	200
E14S50/7Q+M14500	342	1536	4727	2315	2412	290	337	262	200

Holes Trous Fori		I	L	Counterflange Contrebride Controflangia
M	N			H
N°		Ø [mm]		
8	18	260	288	221,5

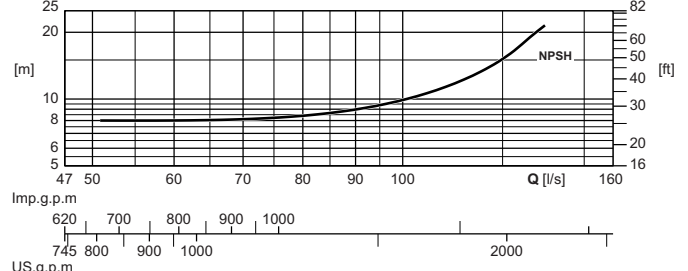
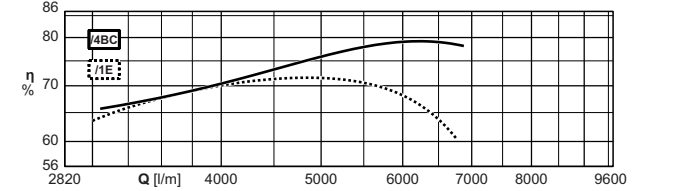
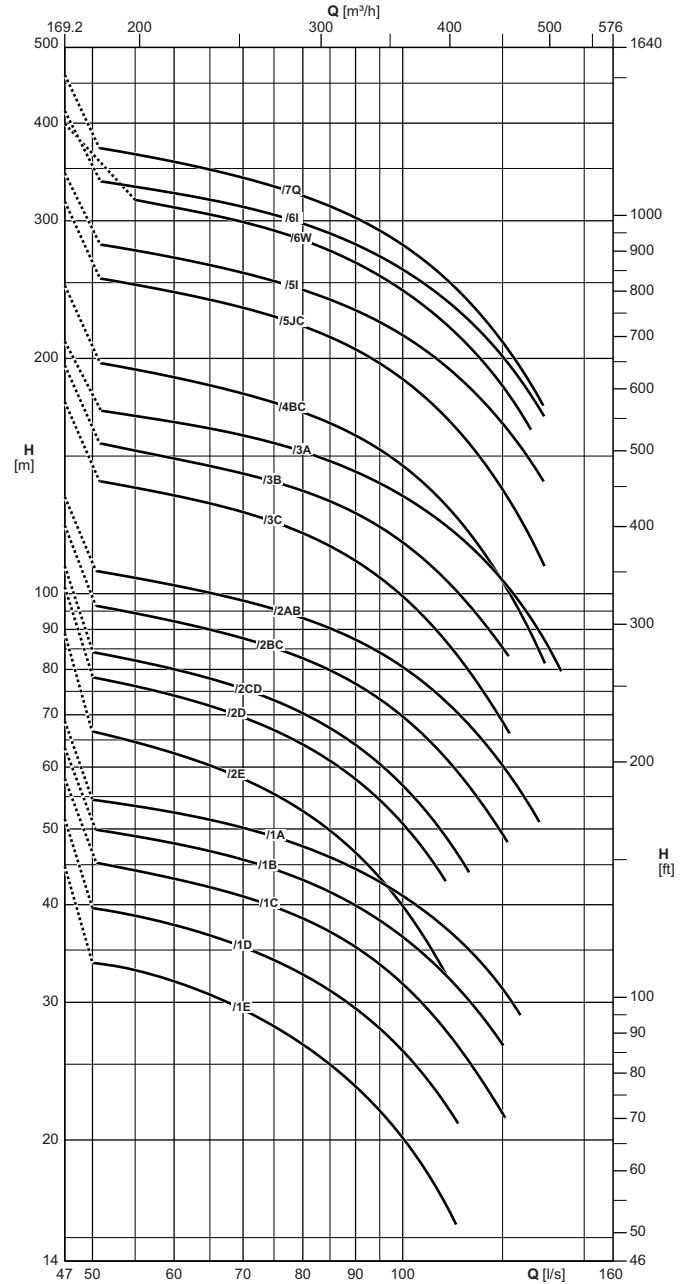

Pumps is equipped with gasket, counterflange and bolts.  
The hydraulic performance characteristics are guaranteed as conforming to standard UNI/ISO 9906 Grade 3B.

La pompe est équipée avec garniture, contrebride et boulons.  
Les caractéristiques hydrauliques de fonctionnement sont garanties conformes à la norme UNI/ISO 9906 Niveau 3B.

La pompa è corredata di guarnizione, controflangia e bulloni  
Le caratteristiche di funzionamento vengono garantite secondo la norma: UNI/ISO 9906 Grado 3B.

Operating data  
Caracteristiques de fonctionnement  
Caratteristiche di funzionamento

Electric pump type Electropompe type Elettropompa tipo	Motor power Puiss. moteur Potenza motore		Horizontal installation Installation horizontale Installazione orizzontale	Check valve $\varnothing$ Clapet de retenue $\varnothing$ Valvola di ritegno $\varnothing$	Capacity Debit Portata														
	[kW]	[HP]			[l/s]	0	60	65	70	75	80	85	90	95	100	110	120	130	140
					[l/min]	0	3600	3900	4200	4500	4800	5100	5400	5700	6000	6600	7200	7800	8400
					[m <sup>3</sup> /h]	0	216	234	252	270	288	306	324	342	360	396	432	468	504
		Head Hauteur Prevalenza																	
		[m]	45	32	30,5	29,5	28	26,5	25	23,5	22	20	16,5	-	-	-	-		
E14S50/1E+MAC840	30	40	<input type="checkbox"/>	$\varnothing$ 200	[m]	45	32	30,5	29,5	28	26,5	25	23,5	22	20	16,5	-	-	-
E14S50/1D+MAC850	37	50	<input type="checkbox"/>	$\varnothing$ 200	[m]	51	37,5	36,5	35,5	34	32,5	31	29,5	28	26	22,5	-	-	-
E14S50/1C+MAC860	45	60	<input type="checkbox"/>	$\varnothing$ 200	[m]	58	43	42	41	40	38,5	37	35,5	33,5	31,5	27,5	23,5	-	-
E14S50/1B+MAC870	51	70	<input type="checkbox"/>	$\varnothing$ 200	[m]	63	48	47	45,5	44,5	43	41,5	40	38	36,5	32,5	28,5	-	-
E14S50/1A+MAC880	59	80	<input type="checkbox"/>	$\varnothing$ 200	[m]	69	52	51	50	49	47,5	46	44,5	43	41	37,5	33,5	29	-
E14S50/2E+MAC880	59	80	<input type="checkbox"/>	$\varnothing$ 200	[m]	89	62	60	58	55	53	49,5	46,5	43,5	40	32,5	-	-	-
E14S50/2D+MAC890	66	90	<input type="checkbox"/>	$\varnothing$ 200	[m]	102	74	72	69	67	64	61	58	54	51	43	-	-	-
E14S50/2CD+MAC8100	75	100	<input type="checkbox"/>	$\varnothing$ 200	[m]	108	80	78	75	73	70	67	64	61	57	49	-	-	-
E14S50/2BC+MAC8125	92	125	<input type="checkbox"/>	$\varnothing$ 200	[m]	122	92	90	88	85	83	80	77	73	69	62	53	-	-
E14S50/2AB+MAC8150	110	150	<input type="checkbox"/>	$\varnothing$ 200	[m]	133	102	100	98	95	93	90	87	84	80	73	64	56	-
E14S50/2CD+MAC10100A	75	100	<input type="checkbox"/>	$\varnothing$ 200	[m]	110	82	80	78	75	72	69	66	62	59	51	42,5	-	-
E14S50/2BC+MAC10125A	92	125	<input type="checkbox"/>	$\varnothing$ 200	[m]	123	94	92	89	87	84	82	79	75	71	64	55	-	-
E14S50/2AB+MAC10150A	110	150	<input type="checkbox"/>	$\varnothing$ 200	[m]	136	105	103	101	99	96	93	90	87	84	76	68	-	-
E14S50/3C+MAC10180A	132	180	<input type="checkbox"/>	$\varnothing$ 200	[m]	176	133	130	127	123	119	115	110	105	99	87	75	-	-
E14S50/3B+MAC10200A	150	200	<input type="checkbox"/>	$\varnothing$ 200	[m]	196	149	146	142	139	135	131	127	122	116	104	91	-	-
E14S50/3A+MAC10250A	185	250	<input type="checkbox"/>	$\varnothing$ 200	[m]	210	166	163	159	156	152	148	143	138	133	122	110	97	83
E14S50/3A+MAC12230A	170	230	<input type="checkbox"/>	$\varnothing$ 200	[m]	210	166	162	159	155	151	147	143	138	133	122	110	-	-
E14SE50/4BC+MAC10250A	185	250	<input type="checkbox"/>	$\varnothing$ 200	[m]	248	189	185	180	175	170	165	159	153	146	130	112	95	-
E14SE50/4BC+MAC12260A	190	260	<input type="checkbox"/>	$\varnothing$ 200	[m]	248	190	185	180	175	169	163	157	150	143	128	112	95	-
E14SE50/4I+MAC12300C	220	300	<input type="checkbox"/>	$\varnothing$ 200	[m]	275	215	210	205	200	195	189	183	176	169	155	140	-	-
E14SE50/4I+M14300	220	300	<input type="checkbox"/>	$\varnothing$ 200	[m]	277	213	209	204	200	195	189	183	177	170	157	142	-	-
E14SE50/5JC+MAC12340C	250	340	<input type="checkbox"/>	$\varnothing$ 200	[m]	318	243	238	232	226	220	213	205	197	188	168	147	125	-
E14SE50/5I+MAC12400C	295	400	<input type="checkbox"/>	$\varnothing$ 200	[m]	345	269	263	257	251	245	238	230	222	214	196	175	154	-
E14SE50/5JC+M14330	240	330	<input type="checkbox"/>	$\varnothing$ 200	[m]	319	243	238	233	227	221	214	206	198	188	168	146	125	-
E14SE50/5I+M14380	280	380	<input type="checkbox"/>	$\varnothing$ 200	[m]	347	270	265	260	255	250	244	237	229	221	202	181	159	-
E14SE50/6W+MAC12475C	350	475	<input type="checkbox"/>	$\varnothing$ 200	[m]	399	312	306	299	291	283	275	265	255	244	221	197	171	-
E14SE50/6I+MAC12475C	350	475	<input type="checkbox"/>	$\varnothing$ 200	[m]	415	325	319	313	305	297	289	280	270	260	238	214	188	-
E14SE50/6W+M14430	315	430	<input type="checkbox"/>	$\varnothing$ 200	[m]	399	310	306	300	294	287	279	270	260	250	226	200	174	-
E14SE50/6I+M14460	340	460	<input type="checkbox"/>	$\varnothing$ 200	[m]	415	326	321	315	308	301	293	284	274	264	241	217	192	-
E14SE50/7Q+MAC12540C	400	540	<input type="checkbox"/>	$\varnothing$ 200	[m]	461	357	349	340	332	323	313	303	291	279	253	225	195	-
E14SE50/7Q+M14500	370	500	<input type="checkbox"/>	$\varnothing$ 200	[m]	465	362	355	348	340	332	323	312	300	288	260	230	200	-
NPSH					[m]	-	6	8	8	8,1	8,3	8,6	8,9	9,2	10	11,5	14	16	19

■ Without conical valve

On request

Please contact our sales organisation

For motor performances specification see page "motor features"

Temperature monitoring device for submersed electric motors 6" + 14": see page "Accessories"

■ Sans soupape du clapet.

Sur demande

Contacter notre service commercial.

Pour caractéristiques techniques moteurs voir page "Caractéristiques des moteurs"

Appareillage de contrôle de la température des moteurs électriques immergés 6" + 14": voir page "Accessories"

■ Senza clapet valvola di ritegno

Su richiesta

Interpellare la sede o la rete di vendita

Per caratteristiche motori vedere pagina "caratteristiche motori"

Apparecchiatura di controllo temperatura motori elettrici sommersi 6" + 14": vedere pagina accessori



Operating data  
Caracteristiques de fonctionnement  
Caratteristiche di funzionamento

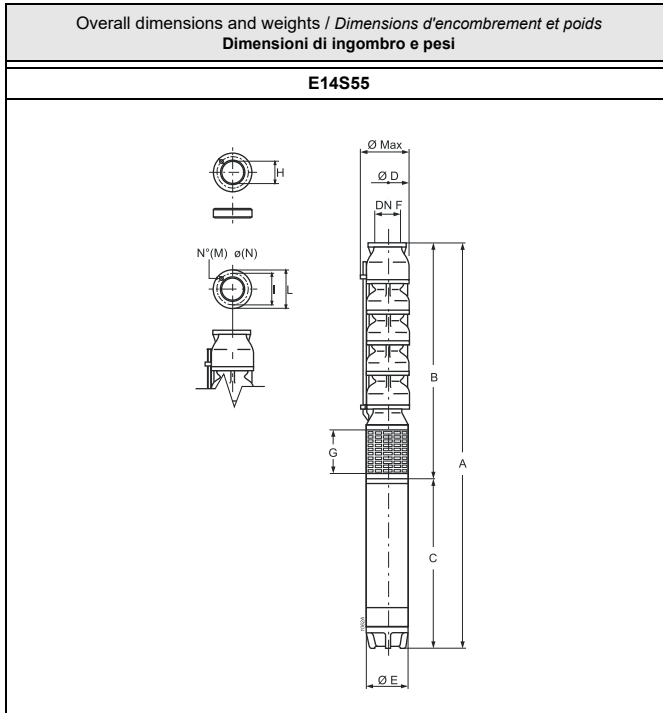

Type Type Tipo	Ø max [mm]	Weight Poids Peso [kg]	[mm]						
			A	B	C	D	E	G	F
E14S55/1FG+MAC850	342	344	2275,5	1160,5	1115	338	191	262	230
E14S55/1EF+MAC860	342	361	2355,5	1160,5	1195	338	191	262	230
E14S55/1DE+MAC870	342	381	2450,5	1160,5	1290	338	191	262	230
E14S55/1CJ+MAC880	342	399	2555,5	1160,5	1395	338	191	262	230
E14S55/1C+MAC890	342	408	2590,5	1160,5	1430	338	191	262	230
E14S55/1B+MAC8100	342	424	2660,5	1160,5	1500	338	191	262	230
E14S55/1A+MAC8125	342	454	2845,5	1160,5	1685	338	191	262	230
E14S55/1B+MAC10100A	342	489	2566,5	1160,5	1406	338	242	262	230
E14S55/1A+MAC10125A	342	527	2696,5	1160,5	1536	338	242	262	230
E14S55/2JF+MAC8125	342	493	3050,5	1365,5	1685	338	191	262	230
E14S55/2JE+MAC8150	342	511	3125,5	1365,5	1760	338	191	262	230
E14S55/2JF+MAC10125A	342	566	2901,5	1365,5	1536	338	242	262	230
E14S55/2JE+MAC10150A	342	601	3006,5	1365,5	1641	338	242	262	230
E14S55/2C+MAC10180A	342	636	3131,5	1365,5	1766	338	242	262	230
E14S55/2JC+MAC10200A	342	664	3231,5	1365,5	1866	338	242	262	230
E14S55/2AB+MAC10250A	342	727	3491,5	1365,5	2126	338	242	262	230
E14S55/2AB+MAC12230A	342	933	3298	1340	1958	338	290	262	230
E14S55/3D+MAC10250A	342	766	3696,5	1570,5	2126	338	242	262	230
E14S55/3D+MAC12230A	342	972	3503	1545	1958	338	290	262	230
E14S55/3JD+MAC12260A	342	1040	3653	1545	2108	338	290	262	230
E14S55/3BC+MAC12300C	342	972	3503	1545	1958	338	290	262	230
E14S55/3B+MAC12340C	342	1040	3653	1545	2108	338	290	262	230
E14S55/3A+MAC12400C	342	1093	3803	1545	2258	338	290	262	230
E14S55/3BC+M14300	342	1093	3472	1545	1927	338	337	262	230
E14S55/3B+M14330	342	1123	3527	1545	1982	338	337	262	230
E14S55/3A+M14380	342	1162	3587	1545	2042	338	337	262	230
E14S55/4BJ+MAC12400C	342	1126	4008	1750	2258	338	290	262	230
E14S55/4B+MAC12475C	342	1151	4058	1750	2308	338	290	262	230
E14S55/4I+MAC12475C	342	1151	4058	1750	2308	338	290	262	230
E14S55/4BJ+M14380	342	1195	3792	1750	2042	338	337	262	230
E14S55/4B+M14430	342	1289	3942	1750	2192	338	337	262	230
E14S55/4I+M14460	342	1350	4042	1750	2292	338	337	262	230
E14S55/5C+MAC12475C	342	1191	4263	1955	2308	338	290	262	230
E14S55/5BC+MAC12540C	342	1212	4313	1955	2358	338	290	262	230
E14S55/5C+M14460	342	1390	4247	1955	2292	338	337	262	230
E14S55/5BC+M14500	342	1472	4367	1955	2412	338	337	262	230

Holes Trous Fori		I	L	Counterflange Contrebride Controflangia
M	N			H
N°		Ø [mm]		
8	20	293	326	247

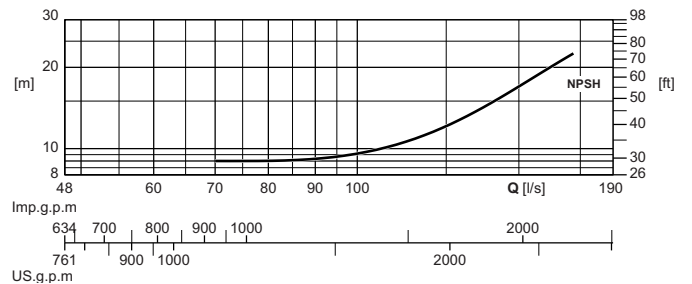
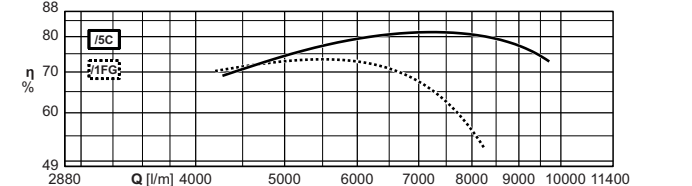
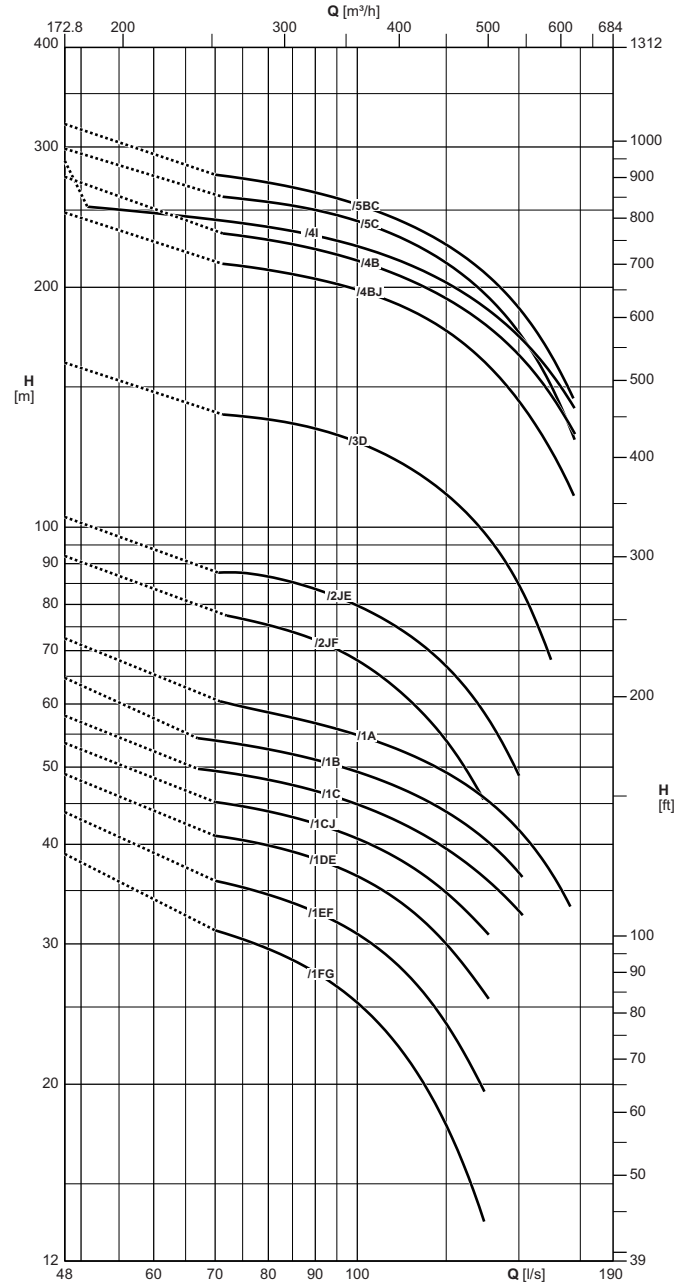

Pumps is equipped with gasket, counterflange and bolts.  
The hydraulic performance characteristics are guaranteed as conforming to standard UNI/ISO 9906 Grade 3B.

La pompe est équipée avec garniture, contrebride et boulons.  
Les caractéristiques hydrauliques de fonctionnement sont garanties conformes à la norme UNI/ISO 9906 Niveau 3B.

La pompa è corredata di guarnizione, controflangia e bulloni  
Le caratteristiche di funzionamento vengono garantite secondo la norma: UNI/ISO 9906 Grado 3B.

Operating data  
Caracteristiques de fonctionnement  
Caratteristiche di funzionamento

Electric pump type Electropompe type Elettropompa tipo	Motor power Puiss. moteur Potenza motore		Horizontal installation Installation horizontale Installazione orizzontale	Check valve $\varnothing$ Clapet de retenue $\varnothing$ Valvola di ritengo $\varnothing$	Capacity Debit Portata													
					[l/s]	0	60	70	80	90	100	110	120	130	140	150	160	170
	[l/min]	0			3600	4200	4800	5400	6000	6600	7200	7800	8400	9000	9600	10200		
[kW]	[HP]	[m <sup>3</sup> /h]	Head Hauteur Prevalenza															
E14S55/1FG+MAC850	37	50	<input type="checkbox"/>	$\varnothing$ 230	[m]	39	-	31	29,5	27,5	25,5	22,5	19,5	16	-	-	-	-
E14S55/1EF+MAC860	45	60	<input type="checkbox"/>	$\varnothing$ 230	[m]	44	-	36	34,5	33	31	28,5	25,5	22	-	-	-	-
E14S55/1DE+MAC870	51	70	<input type="checkbox"/>	$\varnothing$ 230	[m]	49	-	41	40	38,5	36,5	34	31,5	28,5	-	-	-	-
E14S55/1CJ+MAC880	59	80	<input type="checkbox"/>	$\varnothing$ 230	[m]	54	-	45	44	42,5	40,5	38,5	36	33,5	-	-	-	-
E14S55/1C+MAC890	66	90	<input type="checkbox"/>	$\varnothing$ 230	[m]	58	-	49,5	48	46,5	45	43	40,5	38,5	35,5	33	-	-
E14S55/1B+MAC8100	75	100	<input type="radio"/>	$\varnothing$ 230	[m]	65	-	54	53	51	49,5	47,5	45	42,5	40	37	-	-
E14S55/1A+MAC8125	92	125	<input type="radio"/>	$\varnothing$ 230	[m]	72	-	-	59	57	55	53	50	48	45	41,5	38	33,5
E14S55/1B+MAC10100A	75	100	<input type="checkbox"/>	$\varnothing$ 230	[m]	66	-	-	54	52	51	48,5	46,5	44	41	37,5	33,5	-
E14S55/1A+MAC10125A	92	125	<input type="checkbox"/>	$\varnothing$ 230	[m]	72	-	60	58	57	55	53	51	49	46	42,5	38,5	34,5
E14S55/2JF+MAC8125	92	125	<input type="radio"/>	$\varnothing$ 230	[m]	92	-	-	75	72	68	63	57	51	-	-	-	-
E14S55/2JE+MAC8150	110	150	<input type="radio"/>	$\varnothing$ 230	[m]	103	-	-	87	83	80	75	70	64	57	49	-	-
E14S55/2JF+MAC10125A	92	125	<input type="checkbox"/>	$\varnothing$ 230	[m]	93	-	-	77	74	70	65	59	53	-	-	-	-
E14S55/2JE+MAC10150A	110	150	<input type="checkbox"/>	$\varnothing$ 230	[m]	104	-	-	88	85	82	77	72	66	59	-	-	-
E14S55/2C+MAC10180A	132	180	<input type="checkbox"/>	$\varnothing$ 230	[m]	119	-	-	102	100	97	93	88	82	76	68	-	-
E14S55/2JC+MAC10200A	150	200	<input type="radio"/>	$\varnothing$ 230	[m]	133	-	-	111	108	104	100	96	90	84	77	-	-
E14S55/2AB+MAC10250A	185	250	<input type="radio"/>	$\varnothing$ 230	[m]	142	-	-	118	115	111	107	103	98	92	86	79	71
E14S55/2AB+MAC12230A	170	230	<input type="checkbox"/>	$\varnothing$ 230	[m]	142	-	-	119	116	112	108	103	98	92	85	79	71
E14S55/3D+MAC10250A	185	250	<input type="radio"/>	$\varnothing$ 230	[m]	161	-	-	136	133	128	121	114	105	96	84	71	-
E14S55/3D+MAC12230A	170	230	<input type="checkbox"/>	$\varnothing$ 230	[m]	161	-	-	137	134	128	121	113	104	95	-	-	-
E14S55/3JD+MAC12260A	190	260	<input type="checkbox"/>	$\varnothing$ 230	[m]	173	-	-	148	145	139	133	126	117	107	97	86	-
E14S55/3BC+MAC12300C	220	300	<input type="checkbox"/>	$\varnothing$ 230	[m]	198	-	165	161	157	152	146	138	130	121	111	99	87
E14S55/3B+MAC12340C	250	340	<input type="checkbox"/>	$\varnothing$ 230	[m]	206	-	-	172	168	163	157	149	141	131	121	111	100
E14S55/3A+MAC12400C	295	400	<input type="radio"/>	$\varnothing$ 230	[m]	220	-	-	181	176	171	165	158	151	142	132	122	111
E14S55/3BC+M14300	220	300	<input type="radio"/>	$\varnothing$ 230	[m]	198	-	165	163	159	154	148	142	134	125	114	104	-
E14S55/3B+M14330	240	330	<input type="radio"/>	$\varnothing$ 230	[m]	207	-	-	173	168	162	156	149	142	133	123	113	102
E14S55/3A+M14380	280	380	<input type="radio"/>	$\varnothing$ 230	[m]	221	-	-	183	178	172	166	159	152	143	134	124	113
E14SE55/4BJ+MAC12400C	295	400	<input type="radio"/>	$\varnothing$ 230	[m]	248	-	-	210	205	198	191	182	171	158	144	129	113
E14SE55/4B+MAC12475C	350	475	<input type="radio"/>	$\varnothing$ 230	[m]	275	-	-	229	223	216	208	198	188	177	164	150	135
E14SE55/4I+MAC12475C	350	475	<input type="radio"/>	$\varnothing$ 230	[m]	288	248	243	238	232	225	217	208	197	186	173	160	145
E14SE55/4BJ+M14380	280	380	<input type="radio"/>	$\varnothing$ 230	[m]	248	-	-	212	206	200	192	183	173	160	147	131	115
E14SE55/4B+M14430	315	430	<input type="radio"/>	$\varnothing$ 230	[m]	276	-	-	230	223	216	208	199	189	177	165	150	136
E14SE55/4I+M14460	340	460	<input type="radio"/>	$\varnothing$ 230	[m]	289	-	-	240	233	226	218	209	199	188	175	161	147
E14SE55/5C+MAC12475C	350	475	<input type="radio"/>	$\varnothing$ 230	[m]	298	-	-	256	250	242	232	221	208	193	175	156	134
E14SE55/5BC+MAC12540C	400	540	<input type="radio"/>	$\varnothing$ 230	[m]	320	-	277	271	263	254	244	232	219	205	188	170	149
E14SE55/5C+M14460	340	460	<input type="radio"/>	$\varnothing$ 230	[m]	299	-	-	257	251	243	234	223	209	194	176	157	136
E14SE55/5BC+M14500	370	500	<input type="radio"/>	$\varnothing$ 230	[m]	323	-	-	272	265	256	246	235	222	207	190	172	153
NPSH					[m]	-	9	9	8,9	9	9,4	10	11	13,5	15	16	19,5	21

■ Without conical valve

On request

Please contact our sales organisation

For motor performances specification see page "motor features"

Temperature monitoring device for submersed electric motors 6" + 14": see page "Accessories"

■ Sans soupape du clapet.

Sur demande

Contacter notre service commercial.

Pour caractéristiques techniques moteurs voir page "Caractéristiques des moteurs"

Appareillage de contrôle de la température des moteurs électriques immergés 6" + 14": voir page "Accessories"

■ Senza clapet valvola di ritengo

Su richiesta

Interpellare la sede o la rete di vendita

Per caratteristiche motori vedere pagina "caratteristiche motori"

Apparecchiatura di controllo temperatura motori elettrici sommersi 6" + 14": vedere pagina accessori

Operating data  
Caracteristiques de fonctionnement  
Caratteristiche di funzionamento

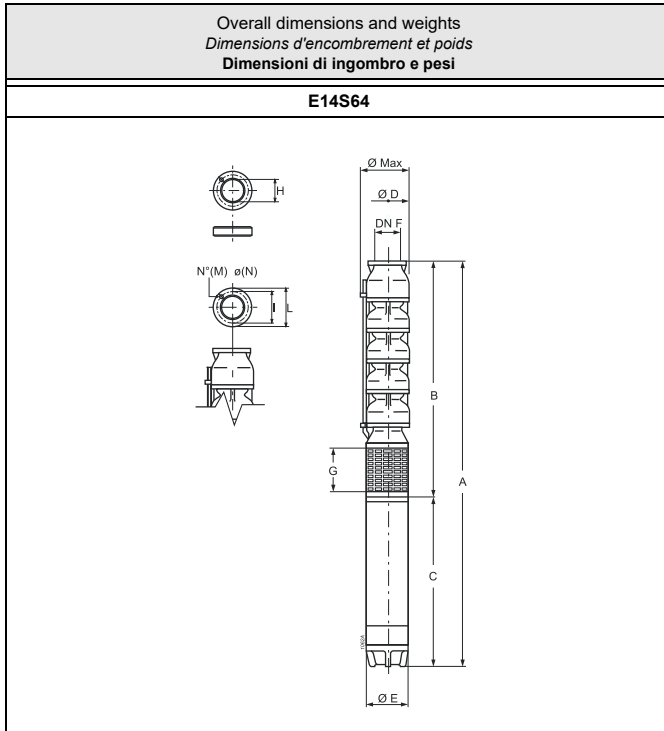

Type Type Tipo	Ø max [mm]	Weight Poids Peso [kg]	A	B	C	D	E	G	F
			[mm]						
E14S64/1L+MAC870	352	372	2307,5	1017,5	1290	338	191	262	230
E14S64/1H+MAC880	352	390	2412,5	1017,5	1395	338	191	262	230
E14S64/1G+MAC890	352	399	2447,5	1017,5	1430	338	191	262	230
E14S64/1F+MAC8100	352	415	2517,5	1017,5	1500	338	191	262	230
E14S64/1D+MAC8125	352	445	2702,5	1017,5	1685	338	191	262	230
E14S64/1B+MAC8150	352	463	2777,5	1017,5	1760	338	191	262	230
E14S64/1F+MAC10100A	352	480	2423,5	1017,5	1406	338	242	262	230
E14S64/1D+MAC10125A	352	518	2553,5	1017,5	1536	338	242	262	230
E14S64/1B+MAC10150A	352	553	2658,5	1017,5	1641	338	242	262	230
E14S64/1A+MAC10180A	352	588	2783,5	1017,5	1766	338	242	262	230
E14S64/2G+MAC10180A	352	640	2998,5	1232,5	1766	338	242	262	230
E14S64/2EF+MAC10200A	352	668	3098,5	1232,5	1866	338	242	262	230
E14S64/2DE+MAC10250A	352	731	3358,5	1232,5	2126	338	242	262	230
E14S64/2DE+MAC12230A	352	936	3138	1180	1958	338	290	262	230
E14S64/2C+MAC12260A	352	1004	3288	1180	2108	338	290	262	230
E14S64/2A+MAC12300C	352	936	3138	1180	1958	338	290	262	230
E14S64/2A+M14300	352	1057	3107	1180	1927	338	337	262	230
E14S64/3JF+MAC12340C	352	1056	3503	1395	2108	338	290	262	230
E14S64/3JD+MAC12400C	352	1109	3653	1395	2258	338	290	262	230
E14S64/3B+MAC12475C	352	1134	3703	1395	2308	338	290	262	230
E14S64/3A+MAC12475C	352	1134	3703	1395	2308	338	290	262	230
E14S64/3JF+M14330	352	1139	3377	1395	1982	338	337	262	230
E14S64/3JD+M14380	352	1178	3437	1395	2042	338	337	262	230
E14S64/3B+M14430	352	1272	3587	1395	2192	338	337	262	230
E14S64/3A+M14460	352	1333	3687	1395	2292	338	337	262	230
E14S64/4CD+MAC12540C	352	1207	3968	1610	2358	338	290	262	230
E14S64/4CD+M14500	352	1467	4022	1610	2412	338	337	262	230

Holes Trous Fori		I	L	Counterflange Contrebride Controflangia
M	N			
N°		Ø [mm]		
8	20	293	326	247

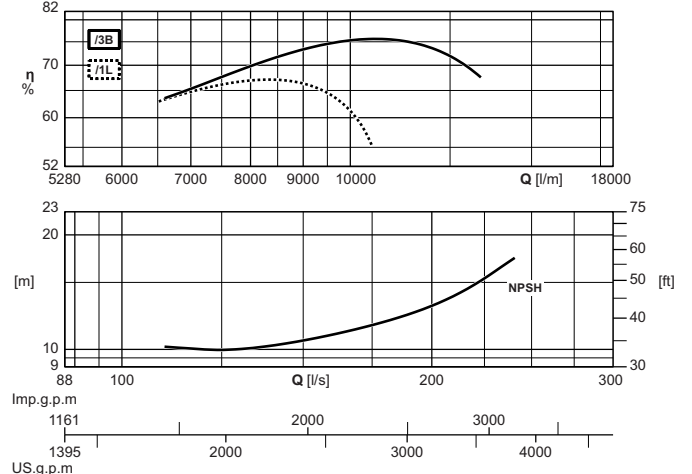
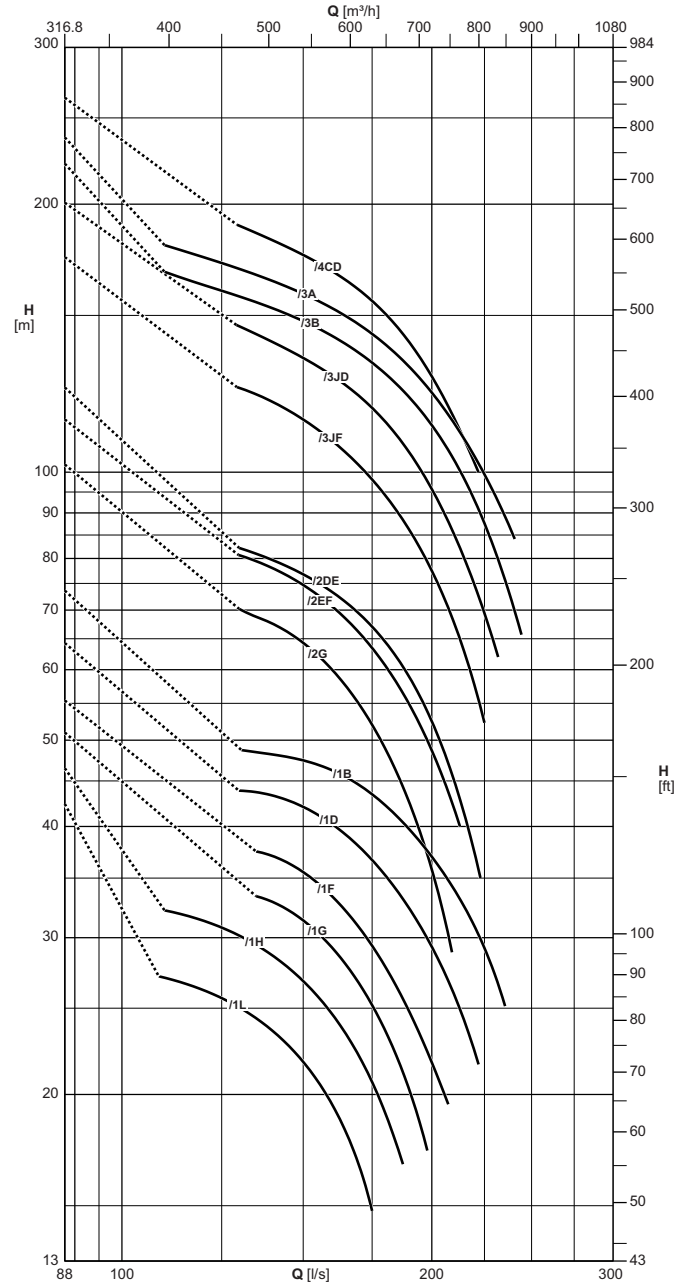

Pumps is equipped with gasket, counterflange and bolts.  
The hydraulic performance characteristics are guaranteed as conforming to standard UNI/ISO 9906 Grade 3B.

La pompe est équipée avec garniture, contrebride et boulons.  
Les caractéristiques hydrauliques de fonctionnement sont garanties conformes à la norme UNI/ISO 9906 Niveau 3B.

La pompa è corredata di guarnizione, controflangia e bulloni  
Le caratteristiche di funzionamento vengono garantite secondo la norma: UNI/ISO 9906 Grado 3B.

Electric pump type Electropompe type Elettropompa tipo	Motor power Puisse. moteur Potenza motore		Horizontal installation Installation horizontale Installazione orizzontale	Check valve $\emptyset$ Clapet de retenue $\emptyset$ Valvola di ritegno $\emptyset$	Capacity Debit Portata												
	[kW]	[HP]			[l/s]	0	110	120	130	140	150	160	170	180	190	200	225
					[l/min]	0	6600	7200	7800	8400	9000	9600	10200	10800	11400	12000	13500
					[m <sup>3</sup> /h]	0	396	432	468	504	540	576	612	648	684	720	810
Head Hauteur Prevalenza																	
[m]	42,5	27	26	25	23,5	21,5	19,5	16,5	-	-	-	-	-	-	-	-	
E14S64/1L+MAC870	51	70	<input type="checkbox"/>	$\emptyset$ 230	[m]	42,5	27	26	25	23,5	21,5	19,5	16,5	-	-	-	-
E14S64/1H+MAC880	59	80	<input type="checkbox"/>	$\emptyset$ 230	[m]	46,5	32	31,5	30	28,5	27	24,5	22	19	-	-	-
E14S64/1G+MAC890	66	90	<input type="checkbox"/>	$\emptyset$ 230	[m]	51	-	-	-	33	31,5	29	26,5	23,5	20,5	-	-
E14S64/1F+MAC8100	75	100	<input type="radio"/>	$\emptyset$ 230	[m]	55	-	-	-	37	35,5	33,5	31	28	25	21,5	-
E14S64/1D+MAC8125	92	125	<input type="radio"/>	$\emptyset$ 230	[m]	64	-	-	44	43,5	42	40	38	35,5	32,5	29,5	-
E14S64/1B+MAC8150	110	150	<input type="radio"/>	$\emptyset$ 230	[m]	73	-	-	-	48	47,5	46	44,5	42,5	39,5	37	29
E14S64/1F+MAC10100A	75	100	<input type="checkbox"/>	$\emptyset$ 230	[m]	55	-	-	-	38	36,5	34	31,5	29	25,5	22,5	-
E14S64/1D+MAC10125A	92	125	<input type="checkbox"/>	$\emptyset$ 230	[m]	65	-	-	-	44,5	43	41	39	36,5	33,5	30,5	-
E14S64/1B+MAC10150A	110	150	<input type="checkbox"/>	$\emptyset$ 230	[m]	75	-	-	-	49,5	49	48	46,5	44,5	42	39	31
E14S64/1A+MAC10180A	132	180	<input type="checkbox"/>	$\emptyset$ 230	[m]	82	-	-	53	53	52	51	50	48,5	46	43,5	35,5
E14S64/2G+MAC10180A	132	180	<input type="checkbox"/>	$\emptyset$ 230	[m]	102	-	-	70	67	64	60	55	49	42,5	36	-
E14S64/2EF+MAC10200A	150	200	<input type="radio"/>	$\emptyset$ 230	[m]	114	-	-	81	78	75	71	66	61	55	48,5	-
E14S64/2DE+MAC10250A	185	250	<input type="radio"/>	$\emptyset$ 230	[m]	124	-	-	82	80	77	73	69	64	59	52	-
E14S64/2DE+MAC12230A	170	230	<input type="checkbox"/>	$\emptyset$ 230	[m]	124	-	-	-	86	83	79	74	69	64	57	-
E14S64/2C+MAC12260A	190	260	<input type="checkbox"/>	$\emptyset$ 230	[m]	138	-	-	-	95	92	89	84	79	74	68	53
E14S64/2A+MAC12300C	220	300	<input type="checkbox"/>	$\emptyset$ 230	[m]	158	-	-	110	107	104	100	96	91	86	81	66
E14S64/2A+M14300	220	300	<input type="radio"/>	$\emptyset$ 230	[m]	160	-	-	112	108	105	101	97	92	87	81	66
E14S64/3JF+MAC12340C	250	340	<input type="radio"/>	$\emptyset$ 230	[m]	174	-	-	124	120	114	108	102	94	86	77	52
E14S64/3JD+MAC12400C	295	400	<input type="radio"/>	$\emptyset$ 230	[m]	201	-	-	146	140	134	128	122	114	105	96	69
E14S64/3B+MAC12475C	350	475	<input type="radio"/>	$\emptyset$ 230	[m]	222	168	162	157	153	148	142	136	129	121	113	87
E14S64/3A+MAC12475C	350	475	<input type="radio"/>	$\emptyset$ 230	[m]	238	180	174	169	164	158	153	146	139	131	123	99
E14S64/3JF+M14330	240	330	<input type="radio"/>	$\emptyset$ 230	[m]	175	-	-	-	121	116	110	103	96	87	77	48
E14S64/3JD+M14380	280	380	<input type="radio"/>	$\emptyset$ 230	[m]	202	-	-	-	139	134	129	122	115	107	99	74
E14S64/3B+M14430	315	430	<input type="radio"/>	$\emptyset$ 230	[m]	223	-	-	-	154	150	145	138	131	123	114	90
E14S64/3A+M14460	340	460	<input type="radio"/>	$\emptyset$ 230	[m]	239	-	-	169	164	160	155	148	141	133	126	103
E14S64/4CD+MAC12540C	400	540	<input type="radio"/>	$\emptyset$ 230	[m]	263	-	-	189	182	175	168	160	151	140	128	-
E14S64/4CD+M14500	370	500	<input type="radio"/>	$\emptyset$ 230	[m]	266	-	-	-	186	180	172	163	152	141	129	96
NPSH					[m]	-	9,8	9,9	10	10	10,5	11	11,5	12	12,5	13	15

■ Without conical valve

On request

Please contact our sales organisation

For motor performances specification see page "motor features"

Temperature monitoring device for submersed electric motors 6" + 14": see page "Accessories"

■ Sans soupape du clapet.

Sur demande

Contacter notre service commercial.

Pour caractéristiques techniques moteurs voir page "Caractéristiques des moteurs"

Appareillage de contrôle de la température des moteurs électriques immergés 6" + 14": voir page "Accessories"

■ Senza clapet valvola di ritegno

Su richiesta

Interpellare la sede o la rete di vendita

Per caratteristiche motori vedere pagina "caratteristiche motori"

Apparecchiatura di controllo temperatura motori elettrici sommersi 6" + 14": vedere pagina accessori

Operating data  
Caracteristiques de fonctionnement  
Caratteristiche di funzionamento

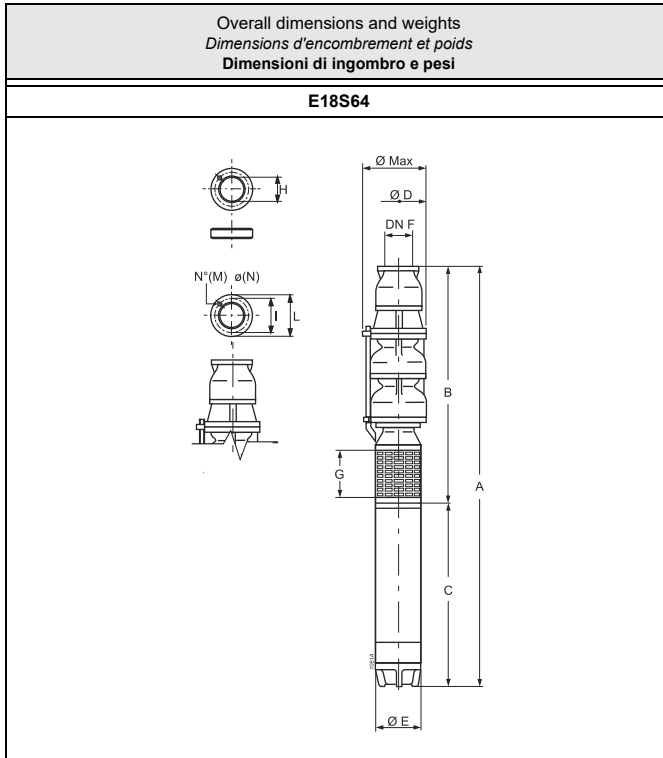

Type Type Tipo	Ø max [mm]	Weight Poids Peso [kg]	A	B	C	D	E	G	F
			[mm]						
E18S64/1L+MAC870	435	452	2490,5	1200,5	1290	384	191	262	230
E18S64/1H+MAC880	435	470	2595,5	1200,5	1395	384	191	262	230
E18S64/1G+MAC890	435	479	2630,5	1200,5	1430	384	191	262	230
E18S64/1F+MAC8100	435	495	2700,5	1200,5	1500	384	191	262	230
E18S64/1D+MAC8125	445	525	2885,5	1200,5	1685	384	191	262	230
E18S64/1B+MAC8150	435	543	2960,5	1200,5	1760	384	191	262	230
E18S64/1F+MAC10100A	435	560	2606,5	1200,5	1406	384	242	262	230
E18S64/1D+MAC10125A	435	598	2736,5	1200,5	1536	384	242	262	230
E18S64/1B+MAC10150A	435	633	2841,5	1200,5	1641	384	242	262	230
E18S64/1A+MAC10180A	435	649	2966,5	1200,5	1766	384	242	262	230
E18S64/2G+MAC10180A	435	744	3236,5	1470,5	1766	384	242	262	230
E18S64/2EF+MAC10200A	435	772	3336,5	1470,5	1866	384	242	262	230
E18S64/2DE+MAC10250A	435	835	3596,5	1470,5	2126	384	242	262	230
E18S64/2DE+MAC12230A	435	1044	3403	1445	1958	384	290	262	230
E18S64/2C+MAC12260A	435	1112	3553	1445	2108	384	290	262	230
E18S64/2A+MAC12300C	435	1044	3403	1445	1958	384	290	262	230
E18S64/2A+M14300	435	1165	3372	1445	1927	384	337	262	230
E18S64/3JF+MAC12340C	435	1188	3823	1715	2108	384	290	262	230
E18S64/3B+MAC12475C	435	1266	4023	1715	2308	384	290	262	230
E18S64/3A+MAC12475C	435	1266	4023	1715	2308	384	290	262	230
E18S64/3JF+M14330	435	1271	3697	1715	1982	384	337	262	230
E18S64/3B+M14430	435	1404	3907	1715	2192	384	337	262	230
E18S64/3A+M14460	435	1465	4007	1715	2292	384	337	262	230
E18S64/4CD+MAC12540C	435	1363	4343	1985	2358	384	290	262	230
E18S64/4CD+M14500	435	1623	4397	1985	2412	384	337	262	230

Holes Trous Fori		I	L	Counterflange Contrebride Controflangia
M	N			
N°		Ø [mm]		
8	20	293	326	247

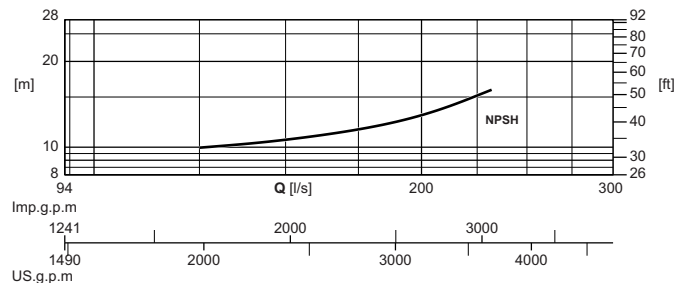
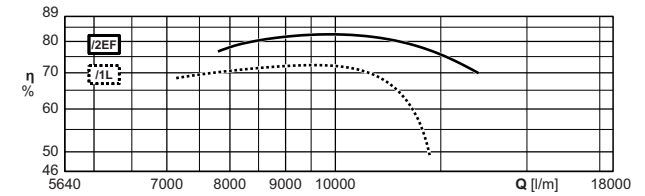
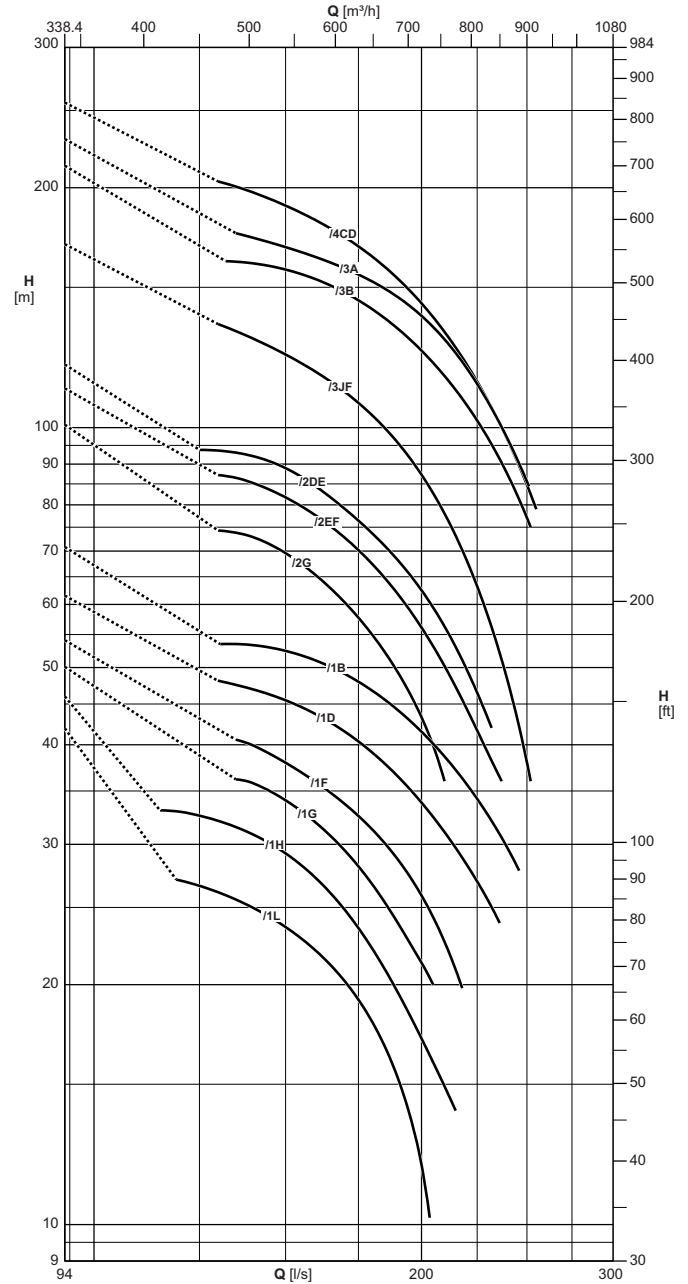

Pumps is equipped with gasket, counterflange and bolts.  
The hydraulic performance characteristics are guaranteed as conforming to standard UNI/ISO 9906 Grade 3B.

La pompe est équipée avec garniture, contrebride et boulons.  
Les caractéristiques hydrauliques de fonctionnement sont garanties conformes à la norme UNI/ISO 9906 Niveau 3B.

La pompa è corredata di guarnizione, controflangia e bulloni  
Le caratteristiche di funzionamento vengono garantite secondo la norma: UNI/ISO 9906 Grado 3B.

Electric pump type Electropompe type Elettropompa tipo	Motor power Puisse. moteur Potenza motore		Horizontal installation Installation horizontale Installazione orizzontale	Check valve $\emptyset$ Clapet de retenue $\emptyset$ Valvola di ritegno $\emptyset$	Capacity Debit Portata												
	[kW]	[HP]			[l/s]	0	120	130	140	150	160	170	180	190	200	225	250
					[l/min]	0	7200	7800	8400	9000	9600	10200	10800	11400	12000	13500	15000
					[m <sup>3</sup> /h]	0	432	468	504	540	576	612	648	684	720	810	900
Head Hauteur Prevalenza																	
E18S64/1L+MAC870	51	70	<input type="radio"/>	$\emptyset$ 230	[m]	42	27	26	25	23,5	22	20	18	15,5	12	-	-
E18S64/1H+MAC880	59	80	<input type="radio"/>	$\emptyset$ 230	[m]	46	33	32	31	29	27	25	22,5	19,5	17	-	-
E18S64/1G+MAC890	66	90	<input type="radio"/>	$\emptyset$ 230	[m]	50	-	-	36	34	32	29,5	27	24	21,5	-	-
E18S64/1F+MAC8100	75	100	<input type="radio"/>	$\emptyset$ 230	[m]	54	-	-	40	38	36	33,5	31,5	29	26	-	-
E18S64/1D+MAC8125	92	125	<input type="radio"/>	$\emptyset$ 230	[m]	61	-	48	47	45,5	43,5	41,5	39	36,5	34	27	-
E18S64/1B+MAC8150	110	150	<input type="radio"/>	$\emptyset$ 230	[m]	71	-	-	53	52	51	49	47	44,5	41,5	34	-
E18S64/1F+MAC10100A	75	100	<input type="radio"/>	$\emptyset$ 230	[m]	55	-	-	40,5	39	37	35	32,5	29,5	27	-	-
E18S64/1D+MAC10125A	92	125	<input type="radio"/>	$\emptyset$ 230	[m]	62	-	-	48,5	47	45	43	40,5	37,5	35	28	-
E18S64/1B+MAC10150A	110	150	<input type="radio"/>	$\emptyset$ 230	[m]	72	-	-	55	54	53	51	49	46,5	44	37	-
E18S64/1A+MAC10180A	132	180	<input type="radio"/>	$\emptyset$ 230	[m]	77	60	59	58	57	56	55	53	50	48	41	32
E18S64/2G+MAC10180A	132	180	<input type="radio"/>	$\emptyset$ 230	[m]	101	-	74	73	69	65	60	55	49,5	43,5	-	-
E18S64/2EF+MAC10200A	150	200	<input type="radio"/>	$\emptyset$ 230	[m]	112	-	87	85	82	77	73	67	62	56	41,5	-
E18S64/2DE+MAC10250A	185	250	<input type="radio"/>	$\emptyset$ 230	[m]	120	-	93	92	89	84	79	74	68	62	46,5	-
E18S64/2DE+MAC12230A	170	230	<input type="radio"/>	$\emptyset$ 230	[m]	120	-	94	93	90	87	83	78	72	66	49	-
E18S64/2C+MAC12260A	190	260	<input type="radio"/>	$\emptyset$ 230	[m]	133	-	-	102	99	96	92	87	82	76	61	-
E18S64/2A+MAC12300C	220	300	<input type="radio"/>	$\emptyset$ 230	[m]	153	-	118	115	112	109	105	101	96	91	76	58
E18S64/2A+M14300	220	300	<input type="radio"/>	$\emptyset$ 230	[m]	154	-	117	114	111	108	105	101	96	91	76	59
E18S64/3JF+MAC12340C	250	340	<input type="radio"/>	$\emptyset$ 230	[m]	170	-	135	129	123	117	111	104	96	87	63	38
E18S64/3B+MAC12475C	350	475	<input type="radio"/>	$\emptyset$ 230	[m]	213	-	-	161	158	153	148	141	133	125	102	77
E18S64/3A+MAC12475C	350	475	<input type="radio"/>	$\emptyset$ 230	[m]	230	-	-	173	168	163	158	152	146	138	113	85
E18S64/3JF+M14330	240	330	<input type="radio"/>	$\emptyset$ 230	[m]	171	-	-	130	125	119	112	105	97	88	64	36,5
E18S64/3B+M14430	315	430	<input type="radio"/>	$\emptyset$ 230	[m]	214	-	-	162	159	155	150	143	136	127	103	76
E18S64/3A+M14460	340	460	<input type="radio"/>	$\emptyset$ 230	[m]	232	-	-	173	170	167	162	155	148	140	116	88
E18S64/4CD+MAC12540C	400	540	<input type="radio"/>	$\emptyset$ 230	[m]	256	-	204	197	190	182	173	164	154	143	114	85
E18S64/4CD+M14500	370	500	<input type="radio"/>	$\emptyset$ 230	[m]	258	-	-	200	195	187	179	169	158	147	115	78
NPSH					[m]	-	10	8,6	10	10,5	11	11,5	12	12,5	13	16	19,5

Without conical valve

On request

Please contact our sales organisation

For motor performances specification see page "motor features"

Temperature monitoring device for submersed electric motors 6" + 14": see page "Accessories"

Sans soupape du clapet.

Sur demande

Contacter notre service commercial.

Pour caracteristiques techniques moteurs voir page "Caracteristiques des moteurs"

Appareillage de contrôle de la température des moteurs électriques immergés 6" + 14": voir page "Accessories"

Senza clapet valvola di ritegno

Su richiesta

Interpellare la sede o la rete di vendita

Per caratteristiche motori vedere pagina "caratteristiche motori"

Apparecchiatura di controllo temperatura motori elettrici sommersi 6" + 14": vedere pagina accessori

Friction losses  
Pertes de charge  
Perdite di carico

In the check valves of MIXED-FLOW pumps  
Dans les clapets de retenue des électropompes SEMI-AXIALES  
Nelle valvole di ritegno delle elettropompe SEMIASSIALI

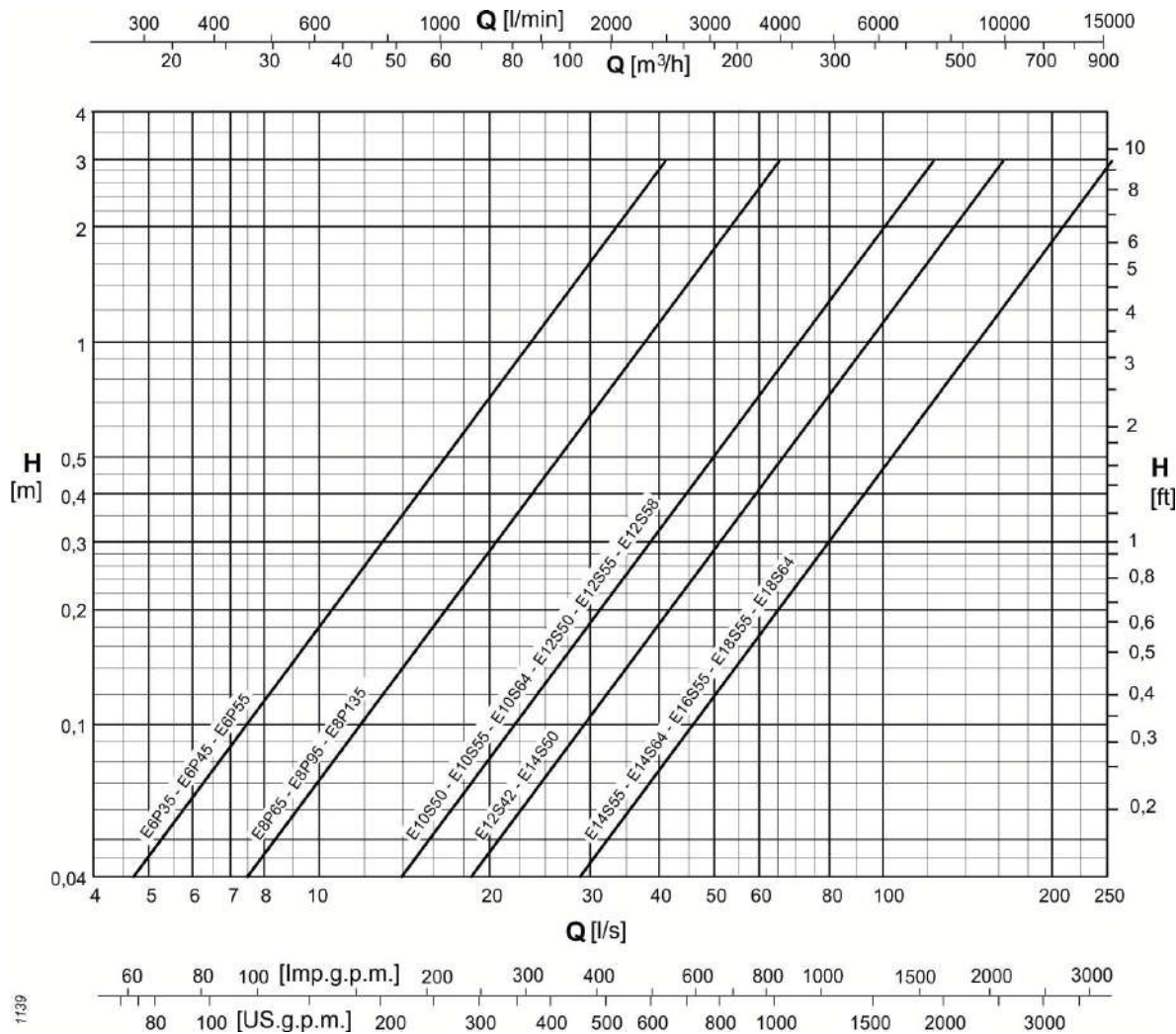

N.B. Friction losses in the check valves of radial pumps are included in the total head.  
*Les pertes de charge dans les clapets de retenue des électropompes radiales sont comprises dans la HMT.*  
**Le perdite di carico nelle valvole di ritegno delle elettropompe radiali sono già conteggiate nella prevalenza totale.**

1139

Friction losses  
 Pertes de charge  
 Perdite di carico

In feet every 100 feet of straight pipeline  
 En mètres pour 100 mètres de tuyauterie droite  
 In metri ogni 100 metri di tubazione dritta

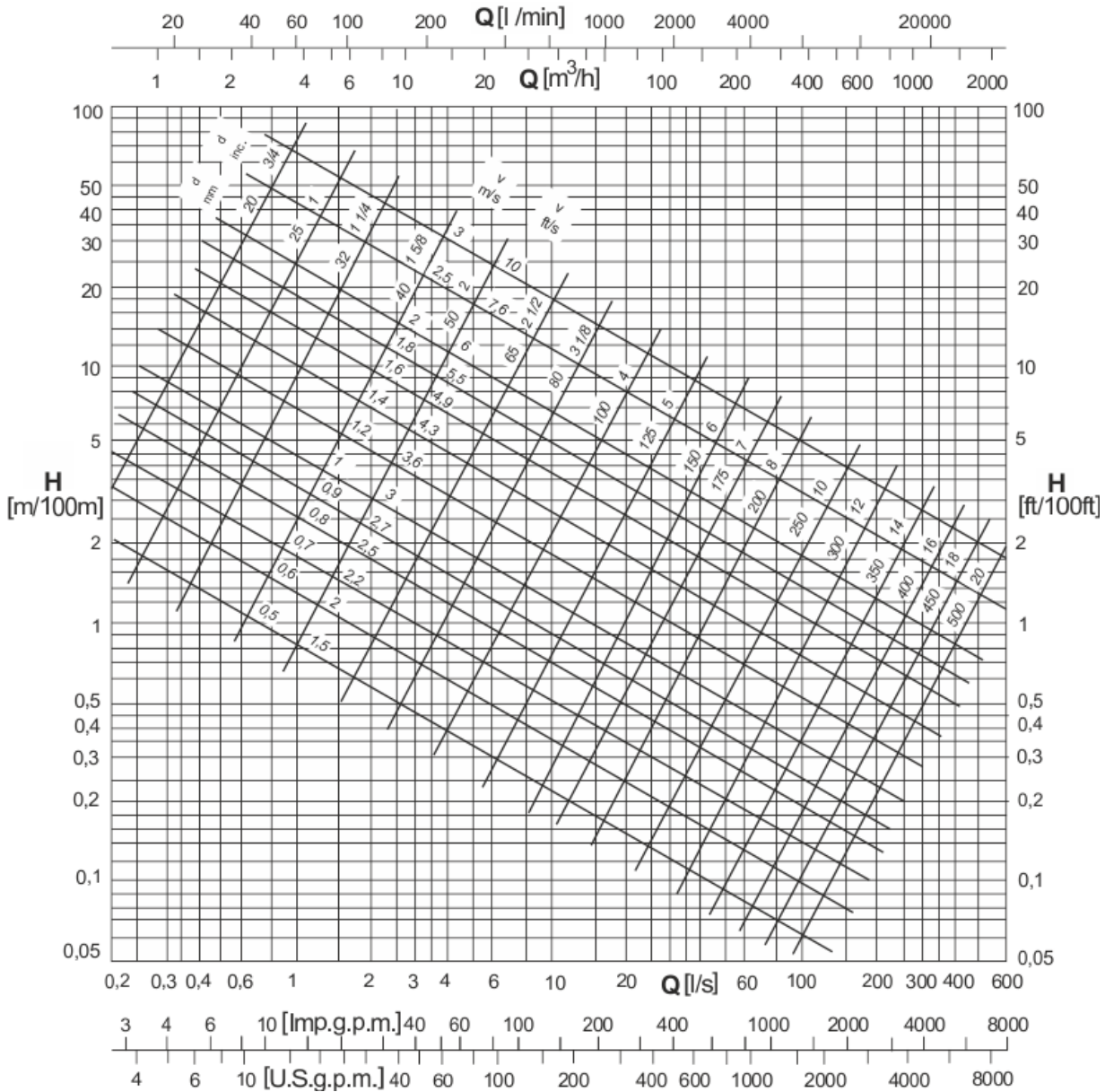

Notes: Above mentioned values are to be intended for internally smooth cast iron pipes.

For an estimated evaluation, friction losses must be multiplied for:

- 0,8 for new rolled steel pipes
- 1,25 for slightly rusted steel pipes
- 0,7 for aluminium pipes
- 0,65 for PVC pipes
- 1,25 for asbestos cement pipes

Q = Capacity  
 v = Velocity of water  
 d = Diameter of pipe  
 h = Friction loss

Notes: Les valeurs doivent s'entendre pour tuyaux en fonte, lisses à l'intérieur.

Pour une évaluation approximative, les pertes de charge doivent être multipliées par:

- 0,8 pour tuyaux laminés nouveaux en acier
- 1,25 pour tuyaux légèrement rouillés en acier
- 0,7 pour tuyaux en aluminium
- 0,65 pour tuyaux en PVC
- 1,25 pour tuyaux en fibro-ciment

Q = Débit  
 v = Vitesse de l'eau  
 d = Diamètre du tuyau  
 h = Perte de charge

Note: I valori sopra indicati s'intendono per tubi lisci in ghisa.

Per una valutazione di massima, le perdite di carico devono essere moltiplicate per:

- 0,8 per tubi di acciaio laminati nuovi
- 1,25 per tubi di acciaio leggermente arrugginiti
- 0,7 per tubi di alluminio
- 0,65 per tubi in PVC
- 1,25 per tubi in fibro-cemento

Q = portata  
 v = velocità dell'acqua  
 d = diametro del tubo  
 h = perdita di carico

















Overall dimensions and weights  
 Dimensions d'encombrement et poids  
 Dimensioni di ingombro e pesi

	Motor type Moteur type Motore tipo	Coupling flange Bride d'accouplement Flangia accoppiamento	Motor weight Poids moteur Peso motore	L	Ø E	S	Axial load Charge axiale Carico assiale	Length A Longueur A Lunghezza A	Cables outlet Sortie des câbles Uscita cavi											
									Cross section [mm <sup>2</sup> ] Section en [mm <sup>2</sup> ] Sezione in [mm <sup>2</sup> ]								Starting Démarrage Avviamento			
									Direct Direct Diretto								Star-delta Etoile-triangle Stella-triangolo			
									230	230 - 400	400	400 - 700	415	500	230 / 400	400 / 700				
	M14300	12"	812	1927	337	76	80000	5 / 6(195)5	-	-	6x(1x70)x5 / 6x(1x95) (C.C.:8)	-	6x(1x70)x5 / 6x(1x95) (C.C.:5)	6x(1x70)x5 / 6x(1x95) (C.C.:4)	-	-				
	M14330	12"	842	1982	337	76	80000	5 / 6(195)5	-	-	6x(1x70)x5 / 6x(1x95) (C.C.:8)	-	6x(1x70)x5 / 6x(1x95) (C.C.:5)	6x(1x70)x5 / 6x(1x95) (C.C.:4)	-	-				
	M14380	12"	881	2042	337	76	80000	5 / -	-	-	6x(1x95) (C.C.:8)	-	6x(1x95) (C.C.:5)	6x(1x95) (C.C.:4)	-	-				
	M14430	12"	975	2192	337	76	80000	5 / -	-	-	6x(1x95) (C.C.:8)	-	6x(1x95) (C.C.:5)	6x(1x95) (C.C.:4)	-	-				
	M14460	12"	1036	2292	337	76	80000	5 / -	-	-	6x(1x95) (C.C.:8)	-	6x(1x95) (C.C.:5)	6x(1x95) (C.C.:4)	-	-				
	M14500	12"	1118	2412	337	76	80000	5 / -	-	-	6x(1x95) (C.C.:8)	-	6x(1x95) (C.C.:5)	6x(1x95) (C.C.:4)	-	-				
	M14540	12"	1153	2462	337	76	80000	5 / -	-	-	6x(1x95) (C.C.:8)	-	6x(1x95) (C.C.:5)	6x(1x95) (C.C.:4)	-	-				
	M14600	12"	1196	2512	337	76	80000	5 / -	-	-	6x(1x95) (C.C.:8)	-	6x(1x95) (C.C.:5)	6x(1x95) (C.C.:4)	-	-				

Section (MPC6..) Section (MPC6..) Sezione (MPC6..)	A x B
[mm <sup>2</sup> ]	[mm]
1 x (3 x 2.5)	6,3 x 14
1 x (3 x 4)	7,5 x 17
1 x (3 x 6)	7,9 x 18,5
1 x (3 x 10)	8,8 x 22
1 x (3 x 16)	10,3 x 25,5

Section Section Sezione	F
[mm <sup>2</sup> ]	[mm]
1 x 2.5	6,2
1 x 2.5	6,4
1 x 4	7,0
1 x 4	7,1
1 x 6	7,7
1 x 6	7,9
1 x 10	9,1
1 x 10	9,2
1 x 16	10,25
1 x 16	10,6
1 x 25	11,6
1 x 25	12,5
1 x 35	12,5
1 x 35	13,7
1 x 50	14,45
1 x 50	16,4
1 x 70	16,35
1 x 70	18,6
1 x 95	21,7

C.C = Motor manufacturing code

C.C = Code construction moteur

C.C = Codice costruttivo motore



Dynamic momentum of the wet end  
*Moment dynamique partie hydraulique*  
**Momento dinamico parte idraulica**

Standard construction <i>Exécution standard</i> <b>Esecuzione standard</b>		
Electric pump type <i>Electropompe type</i> <b>Elettropompa tipo</b>	J Wet <i>J Mouillé</i> <b>J Bagnato</b>	
	Single stage <i>Mono étagee</i> <b>Monostadio</b>	For each additional stage <i>Pour chaque étage en plus</i> <b>Per ogni stadio in più</b>
	J=1/4 PD <sup>2</sup>	
[kgm <sup>2</sup> ]		
E6P35 (x 6")	0,00151	0,00141
E6P45 (x 6")	0,00153	0,00142
E6P55 (x 6")	0,00154	0,00143
E8P65 (x 6" - 8")	0,004478	0,004017
E8P95 (x 6" - 8")	0,005613	0,004570
E8P135 (x 6" - 8")	0,004972	0,004505
** E8R35 (x 6")	0,00159	0,00094
** E8R35 (x 8")	0,00199	0,00094
** E8R40 (x 6")	0,00235	0,00170
** E8R40 (x 8")	0,00274	0,00170
E10R30 (x 8" - 10")	0,00774	0,00607
E10R35 (x 8" - 10")	0,00737	0,00571
E10R40 (x 8" - 10")	0,00738	0,00571
E10S50 (x 6")	0,01050	0,00979
E10S50 (x 8" - 10")	0,01149	0,00979
E10S50 (x 12")	0,01391	0,00979
E10S55 (x 6")	0,01083	0,01011
E10S55 (x 8" - 10" - 12")	0,01182	0,01011
E10S64 (x 6")	0,01963	0,01908
E10S64 (x 8" - 10")	0,02031	0,01907
** E12S42 (x 12" - 14")	0,04776	0,04268
E12S50 (x 6")	0,02058	0,01975
E12S50 (x 8" - 10")	0,01801	0,01646
E12S50 (x 12" - 14")	0,02054	0,01646
E12S55 (x 6")	0,01715	0,01646
E12S55 (x 8" - 10")	0,01814	0,01646
E12S55 (x 12" - 14")	0,02054	0,01646
E12S58 (x 6")	0,01987	0,01938
E12S58 (x 8" - 10")	0,02059	0,01938
E12S58 (x 12" - 14")	0,02269	0,01938
** E14S50 (x 8" - 10" - 12" - 14")	0,05931	0,05278
** E14S55 (x 8" - 10" - 12" - 14")	0,05363	0,04714
** E14S64 (x 8" - 10" - 12" - 14")	0,09268	0,08190
** E18S64 (x 8" - 10" - 12" - 14")	0,09363	0,08718

\*\* Standard construction with stainless steel impeller.

\*\* *Exécution standard avec roues en acier inox.*

\*\* **Esecuzione standard con giranti in acciaio inox**

Bronze impellers construction <i>Exécution avec roues en bronze</i> <b>Esecuzione con giranti in bronzo</b>		
Electric pump type <i>Electropompe type</i> <b>Elettropompa tipo</b>	J Wet <i>J Mouillé</i> <b>J Bagnato</b>	
	Single stage <i>Mono étagee</i> <b>Monostadio</b>	For each additional stage <i>Pour chaque étage en plus</i> <b>Per ogni stadio in più</b>
	J=1/4 PD <sup>2</sup>	
[kgm <sup>2</sup> ]		
E6P35U (x 6")	0,00177	0,00167
E6P45U (x 6")	0,00176	0,00166
E6P55U (x 6")	0,00176	0,00166
E8P65U (x 6" - 8")	0,005210	0,004750
E8P95U (x 6" - 8")	0,006411	0,005368
E8P135U (x 6" - 8")	0,005924	0,005456
E10R30U (x 8" - 10")	0,00928	0,00728
E10R35U (x 8" - 10")	0,00784	0,00618
E10R40U (x 8" - 10")	0,00861	0,00694
E10S50U (x 6")	0,01260	0,01175
E10S50U (x 8" - 10")	0,01359	0,01188
E10S50U (x 12")	0,01600	0,01188
E10S55U (x 6")	0,01299	0,01213
E10S55U (x 8" - 10")	0,01418	0,01213
E10S55U (x 12")	0,01669	0,01232
E10S64U (x 6")	0,02278	0,02223
E10S64U (x 8" - 10")	0,02346	0,02222
E12S50U (x 8" - 10")	0,02161	0,01975
E12S50U (x 12" - 14")	0,02412	0,02003
E12S55U (x 6")	0,01865	0,01794
E12S58U (x 6")	0,02312	0,02263
E12S58U (x 8" - 10")	0,02384	0,02263
E12S58U (x 12" - 14")	0,02594	0,02263

Stainless steel impellers construction <i>Exécution avec roues en acier inox</i> <b>Esecuzione con giranti inox</b>		
Electric pump type <i>Electropompe type</i> <b>Elettropompa tipo</b>	J Wet <i>J Mouillé</i> <b>J Bagnato</b>	
	Single stage <i>Mono étagee</i> <b>Monostadio</b>	For each additional stage <i>Pour chaque étage en plus</i> <b>Per ogni stadio in più</b>
	J=1/4 PD <sup>2</sup>	
[kgm <sup>2</sup> ]		
E12S55X (x 8" - 10")	0,01947	0,01780
E12S55X (x 12" - 14")	0,02188	0,01780

Dynamic momentum of the motor  
Moment dynamique moteur  
Momento dinamico motore

Dynamic momentum of the motor Moment dynamique moteur Momento dinamico motore	
Motor type Moteur type Motore tipo	J=1/4 PD <sup>2</sup> [kgm <sup>2</sup> ]
MPC65/3A	0,0029
MPC67/3A	0,0043
MPC610/3A	0,0052
MPC612/3A	0,0057
MPC615/3A	0,0063
MPC617/3A	0,0072
MPC620/3A	0,0079
MPC625/3A	0,0093
MPC630/3A	0,0101
MPC635/3A	0,0120
MPC640/3A	0,0139
MPC650/3A	0,0155
MPC840/1A	0,0271
MPC850/1A	0,0302
MPC860/1A	0,0332
MPC870/1A	0,0380
MPC880/1A	0,0465
MPC890/1A	0,0489
MPC8100/1A	0,0568
MPC8125/1A	0,0643
MPC10100/1A	0,1001
MPC10125/1A	0,1204
MPC10150/1A	0,1547
MPC10180/1A	0,1656
MPC10200/1A	0,1734
MAC65/3A	0,0029
MAC65/3A	0,0029
MAC67/3A	0,0040
MAC67/3A	0,0040
MAC610/3A	0,0054
MAC610/3A	0,0054
MAC612/3A	0,0065
MAC612/3A	0,0065
MAC615/3A	0,0068
MAC615/3A	0,0068
MAC617/3A	0,0077
MAC617/3A	0,0077
MAC620/3A	0,0086
MAC620/3A	0,0086
MAC625/3A	0,0096
MAC625/3A	0,0096
MAC630/3A	0,0120
MAC630/3A	0,0120
MAC635/3A	0,0150
MAC635/3A	0,0150
MAC640/3A	0,0180
MAC640/3A	0,0180
MAC650/3A	0,0200

Dynamic momentum of the motor Moment dynamique moteur Momento dinamico motore	
Motor type Moteur type Motore tipo	J=1/4 PD <sup>2</sup> [kgm <sup>2</sup> ]
MAC65/3B	0,0042
MAC65/3B	0,0042
MAC67/3B	0,0053
MAC67/3B	0,0053
MAC610/3B	0,0065
MAC610/3B	0,0065
MAC612/3B	0,0077
MAC612/3B	0,0077
MAC615/3B	0,0086
MAC615/3B	0,0086
MAC617/3B	0,0096
MAC617/3B	0,0096
MAC620/3B	0,0110
MAC620/3B	0,0110
MAC625/3B	0,0120
MAC625/3B	0,0120
MAC630/3B	0,0141
MAC630/3B	0,0141
MAC635/3B	0,0163
MAC635/3B	0,0163
MAC640/3B	0,0183
MAC640/3B	0,0183
MAC650/3B	0,0195
MAC650/3B	0,0195
MAC660/3B	0,0202
MAC660/3B	0,0202
MAC65/3C	0,0042
MAC67/3C	0,0053
MAC610/3C	0,0065
MAC612/3C	0,0077
MAC615/3C	0,0086
MAC617/3C	0,0096
MAC620/3C	0,0110
MAC625/3C	0,0120
MAC630/3C	0,0141
MAC635/3C	0,0163
MAC640/3C	0,0183
MAC840	0,0207
MAC850	0,0235
MAC860	0,0277
MAC870	0,0326
MAC880	0,0380
MAC890	0,0398
MAC8100	0,0434
MAC8125	0,0530
MAC8150	0,057
MAC10100/1A	0,0994
MAC10125/1A	0,1207
MAC10150/1A	0,1375
MAC10180/1A	0,1569
MAC10200/1A	0,1700
MAC10220/1A	0,1880
MAC10250/1A	0,2010
MAC12230/1A	0,339
MAC12260/1A	0,382
MAC12300/1C	0,339
MAC12340/1C	0,382
MAC12400/1C	0,41
MAC12475/1C	0,429
MAC12540/1C	0,442
M14300	0,486
M14330	0,51
M14380	0,546
M14430	0,631
M14460	0,69
M14500	0,76
M14540	0,79
M14600	0,82

Calculation of cross-section  
Calcul de la section  
Calcolo della sezione

The choice of the feeding cable is made considering:

1. acceptable voltage drop
2. power loss in the cable
3. maximum current admitted by the cable.

Le choix du câble d'alimentation s'effectue sur la base:

1. de la chute de tension admissible
2. de la perte de puissance dans la longueur considérée
3. de l'intensité maximale admissible dans le câble.

La scelta del cavo di alimentazione si effettua sulla base:

1. della caduta di tensione ammissibile
2. della potenza dissipata lungo il cavo
3. della corrente massima ammissibile nel cavo.

- 1.1. Voltage drop  $\Delta U$  [%] in three-wire cables (resistance only)  
*Chute de tension  $\Delta U$  [%] pour câbles tripolaires (résistance seulement)*  
**Caduta di tensione  $\Delta U$  [%] per cavi tripolari (sola resistenza)**

- 1.1.1. 3-phase motor with - *Moteur triphasé avec* - **Motore trifase con :**

Starting: direct, by statoric impedences, by autotransformer

1 three-wire cable 3 x s

*Démarrage: direct, à impédances statoriques, avec auto-trasformateur*

1 câble trois fils 3 x s

**Avviamento: diretto, a impedenze statoriche, con autotrasformatore**

1 cavo tripolare 3 x s

$$\Delta U = \frac{I \cdot L \cdot \cos \varphi}{s \cdot 32,3} \times \frac{100}{U} : s = \frac{I \cdot L \cdot \cos \varphi}{\Delta U \cdot 32,3} \times \frac{100}{U}$$

- 1.1.2. 3-phase motor with - *Moteur triphasé avec* - **Motore trifase con :**

Starting: star-delta

2 three-wire cable 3 x s

*Démarrage: étoile-triangle*

2 câbles trois fils 3 x s

**Avviamento: stella-triangolo**

2 cavi tripolari 3 x s

$$\Delta U = \frac{I \cdot L \cdot \cos \varphi}{s \cdot 48,5} \times \frac{100}{U} : s = \frac{I \cdot L \cdot \cos \varphi}{\Delta U \cdot 48,5} \times \frac{100}{U}$$

- 1.1.3. Single-phase motor

*Moteur monophasé*

1 three-wire cable 3 x s

**Motore monofase**

1 cavo tripolare 3 x s

$$\Delta U = \frac{I \cdot L \cdot \cos \varphi}{s \cdot 28} \times \frac{100}{U} : s = \frac{I \cdot L \cdot \cos \varphi}{\Delta U \cdot 28} \times \frac{100}{U}$$

- 1.2. Voltage drop  $\Delta U$  [%] in single-wire cables (resistance and reactance)  
*Chute de tension  $\Delta U$  [%] pour câbles unipolaires (résistance et réactance)*  
**Caduta di tensione  $\Delta U$  [%] per cavi unipolari (resistenza e reattanza)**

$$\Delta U = 1,73 \cdot I \cdot L \cdot (R \cdot \cos \varphi + X \cdot \sin \varphi) \cdot \frac{100}{U}$$

- 1.2.1. The voltage drop changes according to the resistance and the reactance induced by single-wires each other according to:  
- the cables cross section  
- their respective position (single, paired, side by side)  
- their angular position (at 120° at 180°)

*La chute de tension varie en fonction de la résistance et de la réactance d'induction causée par les conducteurs entre eux et en fonction de:*

- la section des câbles
- la position entre eux (single, jumelés côte à côte)
- leur position angulaire (à 120° à 180°)

**La caduta di tensione varia in funzione della resistenza e della reattanza induttiva esercitata reciprocamente dai singoli conduttori in funzione:**

- della dimensione dei cavi
- della loro posizione reciproca (singoli, abbinati, affiancati)
- della loro disposizione angolare (a 120° a 180°)

- 1.3. For different supply voltages:

*Pour tensions d'alimentation différentes:*

$$L_N = L \cdot \frac{U_N}{230} : L_N = L \cdot \frac{U_N}{400}$$

**Per tensioni di alimentazione diverse:**

- 1.4. For different power factors:

*Pour cosφ différents:*

$$L_N = L \cdot \frac{0,8}{\cos \varphi}$$

**Per cosφ diversi:**

- 2.1. Power loss  $P_v$  along the feeding cables

*Perte de puissance  $P_v$  le long des câbles d'alimentation*

**Perdita di potenza  $P_v$  lungo i cavi di alimentazione**

$$P_v = I^2 \cdot \frac{L}{s \cdot 18,7} \text{ [W]}$$

**I** = Motor nominal current [A]  
= *Intensité nominale du moteur [A]*  
= **Assorbimento nominale del motore [A]**

**R** = Cable resistance [ $\Omega$ /m]  
= *Résistance et du câble [ $\Omega$ /m]*  
= **Resistenza del cavo [ $\Omega$ /m]**

**U<sub>N</sub>** = New voltage [V]  
= *Nouvelle tension [V]*  
= **Nuova tensione [V]**

**L** = Cable length [m]  
= *Longueur du câble [m]*  
= **Lunghezza del cavo [m]**

**X** = Inductive reactance [ $\Omega$ /m]  
= *Réactance d'induction [ $\Omega$ /m]*  
= **Reattanza induttiva [ $\Omega$ /m]**

**$\Delta U$**  = Voltage drop [%]  
= *Chute de tension [%]*  
= **Caduta di tensione [%]**

**L<sub>N</sub>** = New cable length [m]  
= *Nouvelle longueur du câble [m]*  
= **Nuova lunghezza cavo [m]**

**U** = Nominal voltage [V]  
= *Tension nominale [V]*  
= **Tensione nominale [V]**

**s** = Copper wire cross-section [ $\text{mm}^2$ ]  
= *Section du conducteur en cuivre [ $\text{mm}^2$ ]*  
= **Sezione del conduttore in rame [ $\text{mm}^2$ ]**

**Cos  $\varphi$**  = Full-load power factor (see table motors operating data)  
= *Facteur de puissance à pleine charge (voir tableau caractéristiques moteurs)*  
= **Fattore di potenza a pieno carico (vedi tabella caratteristiche motori)**

Maximum permitted current  
 Courant maximum admissible  
 Corrente massima ammissibile

Tree-wire cables EPDM/EPR* 6" insulated Câbles tripolaires isolés en EPDM/EPR* 6" Cavi tripolari isolati in EPDM/EPR* 6"															
Cable cross-section 3 x s Section du câble 3 x s Sezione del cavo 3 x s	[mm <sup>2</sup> ]	1,5	2,5	4	6	10	16	25	35	50	70	95	120	150	185
I <sub>max</sub> allowable I <sub>max</sub> ammissibile	[A]	23	32	42	54	75	100	127	158	192	246	298	346	399	456
Max. operating temperature Température maximum de service Temperatura max di esercizio	[°C]	90	90	90	90	90	90	90	90	90	90	90	90	90	90

For different environmental temperatures apply the multiplication coefficient K:  
 Pour des températures ambiantes différentes appliquer le coefficient multiplicatif K:  
 Per temperature diverse applicare il coefficiente moltiplicativo K:

Ambient temperature Température ambiante Temperatura ambiente	[°C]	10	15	20	25	30	35	40	45	50
In the open air A l'air libre In aria libera	K	1,15	1,12	1,08	1,04	1	0,96	0,91	0,87	0,82

If two 3-core cables, multiply the max. permitted current detailed in the chart by the coefficient:  
 2 with direct or stator starting (cables in parallel)  
 1,73 with star-delta starting

\* Cables in EPDM/EPR are certified for contact with drinking water in accordance with the following regulations: WRAS (Water Regulations Advisory Scheme) according to BS 6920; ACS (Attestation de Conformité Sanitaire) according to DGS/VS4 99/217 and DGS/VS4 2000/232; Ministerial Decree D.M. 174/04.

En utilisant deux câbles tripolaires, multiplier le courant maximum admissible du tableau par le coefficient:  
 2 pour démarrage direct ou par stator (câbles en parallèle)  
 1,73 pour démarrage étoile-triangle

\* Les câbles en EPDM/EPR sont certifiés au contact direct avec l'eau potable, conformément aux normes: WRAS (Water Regulations Advisory Scheme) suivant la BS 6920; ACS (Attestation de Conformité Sanitaire) suivant les circulaires DGS/VS4 99/217 et DGS/VS4 2000/232; D.M. 174/04.

**N.B. Impiegando due cavi, moltiplicare la corrente massima ammissibile di tabella per il coefficiente:  
 2 con avviamento diretto o statorico (cavi in parallelo)  
 1,73 con avviamento stella-triangolo**

\* I cavi in EPDM/EPR sono certificati al contatto con l'acqua potabile, ai sensi delle normative: WRAS (Water Regulations Advisory Scheme) secondo la BS 6920; ACS (Attestation de Conformité Sanitaire) secondo le DGS/VS4 99/217 e DGS/VS4 2000/232; D.M. 174/04.

Maximum permitted current  
 Courant maximum admissible  
 Corrente massima ammissibile

Tree-wire cables PVC 6" insulated Câbles tripolaires isolés en PVC 6" Cavi tripolari isolati in PVC 6"															
Cable cross-section 3 x s Section du câble 3 x s Sezione del cavo 3 x s	[mm <sup>2</sup> ]	1,5	2,5	4	6	10	16	25	35	50	70	95	120	150	185
I <sub>max</sub> allowable I <sub>max</sub> admissible I <sub>max</sub> ammissibile	[A]	18,5	25	34	43	60	80	101	126	153	196	238	276	319	364
Max. operating temperature Température maximum de service Temperatura max di esercizio	[°C]	70	70	70	70	70	70	70	70	70	70	70	70	70	70

For different environmental temperatures apply the multiplication coefficient K:  
 Pour des températures ambiantes différentes appliquer le coefficient multiplicatif K:  
 Per temperature diverse applicare il coefficiente moltiplicativo K:

Ambient temperature Température ambiante Temperatura ambiente	[°C]	10	15	20	25	30	35	40	45	50
In the open air A l'air libre In aria libera	K	1,22	1,17	1,12	1,06	1	0,94	0,87	0,79	0,71

If two 3-core cables, multiply the max. permitted current detailed in the chart by the coefficient:  
 2 with direct or stator starting (cables in parallel)  
 1,73 with star-delta starting

En utilisant deux câbles tripolaires, multiplier le courant maximum admissible du tableau par le coefficient:  
 2 pour démarrage direct ou par stator (câbles en parallèle)  
 1,73 pour démarrage étoile-triangle

**N.B. Impiegando due cavi, moltiplicare la corrente massima ammissibile di tabella per il coefficiente:  
 2 con avviamento diretto o statorico (cavi in parallelo)  
 1,73 con avviamento stella-triangolo**

Maximum permitted current  
 Courant maximum admissible  
 Corrente massima ammissibile

Single-core cables isolated with EPDM/EPR* 6" Câbles unipolaires isolés en EPDM/EPR* 6" Cavi unipolari isolati in EPDM/EPR* 6"														
Cable cross-section 1 x s Section du câble 1 x s Sezione del cavo 1 x s	[mm <sup>2</sup> ]	2,5	4	6	10	16	25	35	50	70	95	120	150	185
I <sub>max</sub> allowable I <sub>max</sub> admissible I <sub>max</sub> ammissibile	[A]	43	58	75	103	138	182	226	275	353	430	500	577	661
Max. operating temperature Température maximum de service Temperatura max di esercizio	[°C]	90	90	90	90	90	90	90	90	90	90	90	90	90

For different environmental temperatures apply the multiplication coefficient K:  
 Pour des températures ambiantes différentes appliquer le coefficient multiplicatif K:  
 Per temperature diverse applicare il coefficiente moltiplicativo K:

Ambient temperature Température ambiante Temperatura ambiente	[°C]	10	15	20	25	30	35	40	45	50
In the open air A l'air libre In aria libera	K	1,15	1,12	1,08	1,04	1	0,96	0,91	0,87	0,82

If two 3-core cables, multiply the max. permitted current detailed in the chart by the coefficient:  
 2 with direct or stator starting (cables in parallel)  
 1,73 with star-delta starting

\* Cables in EPDM/EPR are certified for contact with drinking water in accordance with the following regulations: WRAS (Water Regulations Advisory Scheme) according to BS 6920; ACS (Attestation de Conformité Sanitaire) according to DGS/VS4 99/217 and DGS/VS4 2000/232; Ministerial Decree D.M. 174/04.

En utilisant deux câbles tripolaires, multiplier le courant maximum admissible du tableau par le coefficient:  
 2 pour démarrage direct ou par stator (câbles en parallèle)  
 1,73 pour démarrage étoile-triangle

\* Les câbles en EPDM/EPR sont certifiés au contact direct avec l'eau potable, conformément aux normes: WRAS (Water Regulations Advisory Scheme) suivant la BS 6920; ACS (Attestation de Conformité Sanitaire) suivant les circulaires DGS/VS4 99/217 et DGS/VS4 2000/232; D.M. 174/04.

**N.B. Impiegando due cavi, moltiplicare la corrente massima ammissibile di tabella per il coefficiente:  
 2 con avviamento diretto o statorico (cavi in parallelo)  
 1,73 con avviamento stella-triangolo**

\* I cavi in EPDM/EPR sono certificati al contatto con l'acqua potabile, ai sensi delle normative: WRAS (Water Regulations Advisory Scheme) secondo la BS 6920; ACS (Attestation de Conformité Sanitaire) secondo le DGS/VS4 99/217 e DGS/VS4 2000/232; D.M. 174/04.

Maximum permitted current  
 Courant maximum admissible  
 Corrente massima ammissibile

Single-core cables isolated with PVC 6" Câbles unipolaires isolés en PVC 6" Cavi unipolari isolati in PVC 6"														
Cable cross-section 1 x s Section du câble 1 x s Sezione del cavo 1 x s	[mm <sup>2</sup> ]	2,5	4	6	10	16	25	35	50	70	95	120	150	185
I <sub>max</sub> allowable I <sub>max</sub> admissible I <sub>max</sub> ammissibile	[A]	26	35	46	63	85	114	143	174	225	275	321	372	427
Max. operating temperature Température maximum de service Temperatura max di esercizio	[°C]	70	70	70	70	70	70	70	70	70	70	70	70	70
For different environmental temperatures apply the multiplication coefficient K: Pour des températures ambiantes différentes appliquer le coefficient multiplicatif K: Per temperature diverse applicare il coefficiente moltiplicativo K:														
Ambient temperature Température ambiante Temperatura ambiente	[°C]	10	15	20	25	30	35	40	45	50				
In the open air A l'air libre In aria libera	K	1,22	1,17	1,12	1,06	1	0,94	0,87	0,79	0,71				

If two 3-core cables, multiply the max. permitted current detailed in the chart by the coefficient:  
 2 with direct or stator starting (cables in parallel)  
 1,73 with star-delta starting

En utilisant deux câbles tripolaires, multiplier le courant maximum admissible du tableau par le coefficient:  
 2 pour démarrage direct ou par stator (câbles en parallèle)  
 1,73 pour démarrage étoile-triangle

**N.B. Impiegando due cavi, moltiplicare la corrente massima ammissibile di tabella per il coefficiente:  
 2 con avviamento diretto o statorico (cavi in parallelo)  
 1,73 con avviamento stella-triangolo**

Max admitted length / *Longueur maxi admise* / *Lunghezze massime ammissibili*

Max length [m] - EPDM/EPR or PVC three-pole power cables  
*Longueur maxi admise [m] - EPDM/EPR ou PVC three-pole power cables*  
**Lunghezza MAX [m] - Cavo di alimentazione Tripolare EPDM/EPR o PVC**

Direct or statoric starting - 3 cables Motor exit- 1 Cable with section (s) 3 x ...  
*Demarrage direct ou statorique - Sortie moteur 3 câbles - 1 Câble, section (s) 3 x ...*  
**Avviamento diretto o statorico - Motore con uscita 3 cavi - 1 cavo di sezione (s) 3 x ...**

I [A]	S [mm <sup>2</sup> ]													
	1,5	2,5	4	6	10	16	25	35	50	70	95	120	150	185
2,5	249	413												
5	124	206	331	493										
7,5	83	138	221	329	560									
10	62	103	165	247	420									
15	41	69	110	164	280	434								
20	<b>31</b>	52	83	123	210	326	491							
25		<b>41</b>	66	99	168	261	393	535						
30		<b>34</b>	55	82	140	217	327	446						
40			<b>41</b>	62	105	163	246	334	462					
50				<b>49</b>	84	130	196	267	370	498				
60					70	109	164	223	308	415	516			
70					<b>60</b>	93	140	191	264	356	442	534		
80						<b>81</b>	123	167	231	311	387	468	546	
90						<b>72</b>	109	149	205	277	344	416	486	554
100						<b>65</b>	<b>98</b>	134	185	249	309	374	437	498
120							<b>82</b>	<b>111</b>	154	208	258	312	364	415
140								<b>96</b>	132	178	221	267	312	356
160									<b>116</b>	156	193	234	273	311
180									<b>103</b>	138	172	208	243	277
200										<b>125</b>	155	187	219	249
220										<b>113</b>	<b>141</b>	170	199	226
240										<b>104</b>	<b>129</b>	156	182	208
260											<b>119</b>	<b>144</b>	168	192
280											<b>110</b>	<b>134</b>	156	178
300												<b>125</b>	<b>146</b>	166
320												<b>117</b>	<b>137</b>	156

Make sure that the current considered is effectively that absorbed by the motor in the real operating conditions.

The lengths given in boldface type refer solely to cables in EPDM/EPR

The cable lengths refer to 30[°C] ambient temperature; installation in air; 400[V] 50[Hz] power supply; cosφ = 0.8 and 3% permissible voltage drop.

Check the selection parameters carefully if the conditions are different (see "Calculation of cross-section" and "Maximum permitted current")

Make sure that the section of the riser cable is the same as the section of the motor output cable, or larger.

If the conditions are different, please contact our sales organization.

*Vérifier que le courant considéré soit effectivement celui absorbé par le moteur dans les conditions réelles de service.*

*Les longueurs marquées en caractères gras se réfèrent aux câbles en EPDM/EPR seulement*

*Les longueurs des câbles se réfèrent à une température ambiante de 30[°C] ; pose à l'air libre; alimentation 400[V] 50[Hz] ; cosφ = 0,8 et chute de tension admissible = 3%. En cas de conditions différentes, vérifier soigneusement les paramètres de sélection (voir "Calcul de la section" et "Courant maximum admissible").*

*Vérifier que la section sélectionnée pour le câble de remontée soit supérieure ou égale à la section du câble de sortie moteur.*

*En cas de conditions différentes, contacter notre service commercial*

**Assicurarsi che la corrente considerata sia effettivamente quella assorbita dal motore nelle condizioni reali d'esercizio.**

**Le lunghezze contrassegnate in grassetto sono riferite solo ai cavi in EPDM/EPR.**

**Le lunghezze dei cavi sono riferite ad una temperatura ambiente di 30[°C]; installazione in aria; alimentazione 400[V] 50[Hz]; cosφ = 0,8 e caduta di tensione ammessa = 3%.**

**Per condizioni diverse, verificare accuratamente i parametri di selezione (vedi "Calcolo della sezione" e "Corrente massima ammissibile").**

**Assicurarsi che la sezione selezionata per il cavo di risalita sia maggiore o uguale alla sezione del cavo d'uscita motore.**

**Per condizioni diverse, interpellare la sede o la rete di vendita.**



Max length [m] - EPDM/EPR or PVC Single-pole power cables - Longueur maxi admise [m] - EPDM/EPR ou PVC Unipolaires power cables -  
**Lunghezza MAX [m] - Cavi di alimentazione unipolari EPDM/EPR o PVC**  
 Direct or statoric starting - 3 cables Motor exit / Démarrage direct ou statorique - Sortie moteur 3 câbles / Avviamento diretto o statorico - Motore con uscita 3 cavi  
 3 Cables wit section (s) 1 x ... / 3 Câble, section (s) 1 x ... / 3 cavi di sezione (s) 1 x ... / 6 Câble cross-section (s) 1 x ... / 6 Cavi di sezione (s) 1 x ...

I [A]	DN <sub> pompa</sub>	S [mm <sup>2</sup> ]																I [A]	DN <sub> pompa</sub>	S [mm <sup>2</sup> ]																						
		2,5	4	6	10	16	25	35	50	70	95	120	150	185	2,5	4	6			10	16	25	35	50	70	95	120	150	185													
10	4"	102	162	239	400																	4"	204	324	478																	
	6"	101	161	237	395	567																	6"	203	322	475																
	8"-9"-10"	101	161	237	394	564																	8"-9"-10"	203	322	474																
	12"	101	160	236	391	568																	12"	202	321	472																

Make sure that the current considered is effectively that absorbed by the motor in the real operating conditions.  
 The lengths given in boldface type refer solely to cables in EPDM/EPR  
 The cable lengths refer to 30°C ambient temperature; installation in air; 400[V] 50[Hz] power supply;  $\cos\phi = 0.8$  and 3% permissible voltage drop. Check the selection parameters carefully if the conditions are different (see "Calculation of cross-section" and "Maximum permitted current")

Vérifier que le courant considéré soit effectivement celui absorbé par le moteur dans les conditions réelles de service.  
 Les longueurs marquées en caractères gras se réfèrent aux câbles en EPDM/EPR seulement.  
 Les longueurs des câbles se réfèrent à une température ambiante de 30°C ; pose à l'air libre; alimentation 400[V] 50[Hz];  $\cos\phi = 0.8$  et chute de tension admissible = 3%. En cas de conditions différentes, vérifier soigneusement les paramètres de sélection (voir "Calcul de la section" et "Courant maximum admissible").

Assicurarsi che la corrente considerata sia effettivamente quella assorbita dal motore nelle condizioni reali d' servizio.  
 Le lunghezze contrassegnate in grassetto sono riferite solo ai cavi in EPDM/EPR.  
 Le lunghezze dei cavi sono riferite ad una temperatura ambiente di 30°C; installazione in aria; alimentazione 400[V] 50[Hz];  $\cos\phi = 0.8$  e caduta di tensione ammessa = 3%. Per condizioni diverse, verificare accuratamente i parametri di selezione (vedi "Calcolo della sezione" e "Corrente massima ammissibile").

Make sure that the section of the riser cable is the same as the section of the motor output cable, or larger.  
 If the conditions are different, please contact our sales organization.

Vérifier que la section sélectionnée pour le câble de remontée soit supérieure ou égale à la section du câble de sortie moteur.  
 En cas de conditions différentes, contacter notre service commercial

Assicurarsi che la sezione selezionata per il cavo di risalita sia maggiore o uguale alla sezione del cavo d'uscita motore.  
 Per condizioni diverse, interpellare la sede o la rete di vendita.

Max length [m] - EPDM/EPR or PVC three-pole power cables - *Longueur maxi admise [m] - EPDM/EPR ou PVC three-pole power cables*

**Lunghezza MAX [m] - Cavo di alimentazione Tripolare EPDM/EPR o PVC**

Star-delta starting - 6 cables Motor exit / *Démarrage étoile-triangle - Sortie moteur 6 câbles* / *Avviamento stella-triangolo - Motore con uscita 6 cavi*  
 2 Cables wit section 3 x ... / *2 Câble, section (s) 3 x ...* / *2 cavi di sezione (s) 3 x ...*

I [A]	S [mm <sup>2</sup> ]													
	1,5	2,5	4	6	10	16	25	35	50	70	95	120	150	185
10	93	155	248	370										
15	62	103	165	247	420									
20	47	77	124	185	315	488								
25	37	62	99	148	252	391	589							
30	31	52	83	123	210	326	491							
40		39	62	92	158	244	368	502						
50		<b>31</b>	50	74	126	195	295	401	554					
60			<b>41</b>	62	105	163	246	334	462					
70			<b>35</b>	53	90	140	210	287	396	534				
80				<b>46</b>	79	122	184	251	347	467	580			
90				<b>41</b>	70	109	164	223	308	415	516			
100					63	98	147	201	277	374	464	561		
120					<b>53</b>	81	123	167	231	311	387	468	546	
140						<b>70</b>	105	143	198	267	331	401	468	534
160						<b>61</b>	92	125	173	233	290	351	410	467
180							<b>82</b>	111	154	208	258	312	364	415
200							<b>74</b>	100	139	187	232	281	328	374
220								<b>91</b>	126	170	211	255	298	340
240								<b>84</b>	116	156	193	234	273	311
260								<b>77</b>	107	144	178	216	252	287
280									<b>99</b>	133	166	200	234	267
300									<b>92</b>	125	155	187	219	249
320									<b>87</b>	117	145	175	205	234

Make sure that the current considered is effectively that absorbed by the motor in the real operating conditions.

The lengths given in boldface type refer solely to cables in EPDM/EPR

The cable lengths refer to 30[°C] ambient temperature; installation in air; 400[V] 50[Hz] power supply;  $\cos\phi = 0,8$  and 3% permissible voltage drop. Check the selection parameters carefully if the conditions are different (see "Calculation of cross-section" and "Maximum permitted current")

Make sure that the section of the riser cable is the same as the section of the motor output cable, or larger.

If the conditions are different, please contact our sales organization.

*Vérifier que le courant considéré soit effectivement celui absorbé par le moteur dans les conditions réelles de service.*

*Les longueurs marquées en caractères gras se réfèrent aux câbles en EPDM/EPR seulement.*

*Les longueurs des câbles se réfèrent à une température ambiante de 30[°C]; pose à l'air libre; alimentation 400[V] 50[Hz];  $\cos\phi = 0,8$  et chute de tension admissible = 3%. En cas de conditions différentes, vérifiez soigneusement les paramètres de sélection (voir "Calcul de la section" et "Courant maximum admissible").*

*Vérifier que la section sélectionnée pour le câble de remontée soit supérieure ou égale à la section du câble de sortie moteur.*

*En cas de conditions différentes, contacter notre service commercial*

Assicurarsi che la corrente considerata sia effettivamente quella assorbita dal motore nelle condizioni reali d'esercizio.

Le lunghezze contrassegnate in grassetto sono riferite solo ai cavi in EPDM/EPR.

Le lunghezze dei cavi sono riferite ad una temperatura ambiente di 30[°C]; installazione in aria; alimentazione 400[V] 50[Hz];  $\cos\phi = 0,8$  e caduta di tensione ammessa = 3%. Per condizioni diverse, verificare accuratamente i parametri di selezione (vedi "Calcolo della sezione" e "Corrente massima ammissibile").

Assicurarsi che la sezione selezionata per il cavo di risalita sia maggiore o uguale alla sezione del cavo d'uscita motore.

Per condizioni diverse, interpellare la sede o la rete di vendita.



Generator power  
Puissance du générateur  
Potenza del generatore

When an electric generator has to be used to supply the motor, it should be carefully selected.  
A chart is provided giving the minimum rating in [kW] and [kVA] of the generators used to supply the motors.

*Dans le cas d'utilisation d'un générateur électrique pour alimenter le moteur, le choix doit être avisé.  
Nous fournissons un tableau indicatif des puissances minimum en [kW] et en [kVA] des générateurs pour l'alimentation des moteurs électriques*

Quando si deve utilizzare un generatore elettrico per l'alimentazione del motore, è necessaria un'oculata scelta.

Forniamo una tabella indicativa delle potenze minime in [kW] ed in [kVA] dei generatori per l'alimentazione dei motori elettrici.

Electric motor power Puissance moteur électrique Potenza motore elettrico		Generator power Puissance du générateur Potenza del generatore	
		Direct starting Démarrage direct Avviamento diretto	
[kW]	[HP]	[kW]	[kVA]
2.2	3	6	7.5
3	4	8	10
4	5.5	10	12.5
5.5	7.5	12.5	15.6
7.5	10	15	18.8
9.2	12.5	18.8	23.5
11	15	22.5	28
13	17.5	26.4	33
15	20	30	38
18.5	25	40	50
22	30	45	57
26	35	52	65
30	40	60	75
37	50	75	94
45	60	90	112
51	70	105	131
59	80	120	150
66	90	135	170
75	100	150	190
92	125	185	230
110	150	210	260

Electric motor power Puissance moteur électrique Potenza motore elettrico		Generator power Puissance du générateur Potenza del generatore	
		Star-delta starting Démarrage étoile-triangle Avviamento stella-triangolo	
[kW]	[HP]	[kW]	[kVA]
-	-	-	-
3	4	6	7.5
4	5.5	8	10
5.5	7.5	10.8	13.5
7.5	10	14	17.5
9.2	12.5	17.2	21.5
11	15	20.5	25.5
13	17.5	23.6	29.5
15	20	27	34
18.5	25	33	42
22	30	40	50
26	35	45	57
30	40	52	65
37	50	65	81
45	60	77	97
51	70	90	112
59	80	102	128
66	90	115	144
75	100	128	160
92	125	158	198
110	150	190	237

VALUES VALEURS GRANDEZZA		ALTERNATING CURRENT COURANT ALTERNATIF CORRENTE ALTERNATA	
		SINGLE-PHASE MONOPHASE MONOFASE	THREE-PHASE TRIPHASE TRIFASE
Absorbed power (active) <i>Puissance absorbée (active)</i> Potenza assorbita (attiva)	[kW]	$P_a = \frac{U \cdot I \cdot \cos \varphi}{1000}$	$P_a = \frac{1,73 \cdot U \cdot I \cdot \cos \varphi}{1000}$
Yield power <i>Puissance utile</i> Potenza resa	[kW]	$P_r = \frac{U \cdot I \cdot \cos \varphi \cdot \eta_M}{1000}$	$P_r = \frac{1,73 \cdot U \cdot I \cdot \cos \varphi \cdot \eta_M}{1000}$
Absorbed current <i>Courant absorbé</i> Corrente assorbita	[A]	$I = \frac{P_r \cdot 1000}{U \cdot \cos \varphi \cdot \eta_M}$	$I = \frac{P_r \cdot 1000}{1,73 \cdot U \cdot \cos \varphi \cdot \eta_M}$
Power factor (cos φ) <i>Facteurs de puissance (cos φ)</i> Fattore di potenza (cos φ)	[0,.....]	$\cos \varphi = \frac{P_a \cdot 1000}{U \cdot I}$	$\cos \varphi = \frac{P_a \cdot 1000}{1,73 \cdot U \cdot I}$
Nominal torque <i>Couple nominal</i> Coppia nominale	[Nm]	$M_N = \frac{P_r \cdot 1000}{0,105 \cdot n}$	
Motor efficiency <i>Rendement du moteur</i> Rendimento motore	[%]	$\eta_M = \frac{P_r}{P_a} \cdot 100$	
Synchronous speed <i>Vitesse de synchronisme</i> Velocità sincrona	[n <sup>-1</sup> ]	$n_s = \frac{f \cdot 120}{\text{No. Poli} / \text{Poles} / \text{Pôles}}$	
Sliding <i>Glissement</i> Scorrimento	[%]	$S = \frac{n_s - n}{n_s} \cdot 100$	

Electrical tolerances  
 Tolérances électriques  
 Tolleranze elettriche

Tolerances on the guaranteed values of the electrical characteristics of asynchronous motors as per CEI norms in accordance with IEC norms.

*Tolérances sur les valeurs garanties des caractéristiques électriques des moteurs asynchrones selon les Normes CEI en accord avec les Normes IEC.*

**Tolleranze sui valori garantiti delle caratteristiche elettriche dei motori asincroni, secondo Norme CEI in accordo con le Norme IEC.**

VALUE VALEURS GRANDEZZA		TOLERANCE TOLERANCE TOLLERANZA
Real efficiency <i>Rendement réel</i> Rendimento effettivo	[ $\eta$ ]	$-0,15 \cdot (1 - \eta_G)$ [%]
Power factor <i>Facteur de puissance</i> Fattore di potenza	[ $\cos \varphi$ ]	$-\frac{1}{6} \cdot (1 - \cos \varphi)$ <span style="font-size: small;">[nim: 0,02 max: 0,07]</span>
Sliding <i>Glissement</i> Scorrimento	[S]	$\pm 20\%$

VALUE VALEURS GRANDEZZA		TOLERANCE TOLERANCE TOLLERANZA
Maximum torque <i>Couple maximal</i> Coppia massima	[ $M_M$ ]	- 10% (min 1,6 $M_N$ ) [Nm]
Starting torque <i>Couple de démarrage</i> Coppia di spunto	[ $M_S$ ]	+ 25% - 15%
Starting current <i>Intensité de démarrage</i> Corrente di spunto	[ $I_S$ ]	+ 20% [A]

Asynchronous motors absorb, from the main, "apparent" electrical power which is partly "active" power, and partly "reactive" power; the latter is used for motor magnetization and cannot be technically eliminated.

The ratio of "active power" to "apparent power" forms the "power factor" or  $\cos \phi$ .

The absorbed reactive power on the line can be reduced, according with the current rules, modifying the phase displacement between absorbed current and supply tension.

Everything must be realised using an appropriate power capacitors battery.

*Les moteurs asynchrones absorbent sur le réseau une puissance électrique "apparente" constituée en partie d'une puissance "active" et en partie d'une puissance "réactive".*

*Cette dernière sert à la magnétisation du moteur et ne peut pas être techniquement supprimée.*

*Le rapport entre "puissance active" et "puissance apparente" constitue le "facteur de puissance" ou  $\cos \phi$ .*

*La puissance réactive absorbée sur la ligne peut être réduite, selon les normes en vigueur, en modifiant le déphasage entre courant absorbée et tension d'alimentation.*

*Ceci devra être réalisé en utilisant une adéquate batterie des condensateurs de puissance.*

I motori asincroni assorbono dalla rete potenza elettrica "apparente" costituita in parte da potenza "attiva" ed in parte da potenza "reattiva"; quest'ultima serve alla magnetizzazione del motore e non può essere tecnicamente soppressa.

Il rapporto fra "potenza attiva" e "potenza apparente" costituisce il "fattore di potenza", o  $\cos \phi$ .

La potenza reattiva assorbita sulla linea può essere ridotta, in base alle norme vigenti, modificando lo sfasamento tra corrente assorbita e la tensione di alimentazione. Ciò dovrà essere realizzato utilizzando opportuna batteria di condensatori di potenza.

Nomogram for determining  $P_c$  power [kVAR] of phase-shift capacitors  
 Nomogramme pour la détermination de la puissance  $P_c$  [kVAR] des condensateurs de rattrapage.  
 Nomogramma per la determinazione della potenza  $P_c$  [kVAR] dei condensatori di rifasamento.

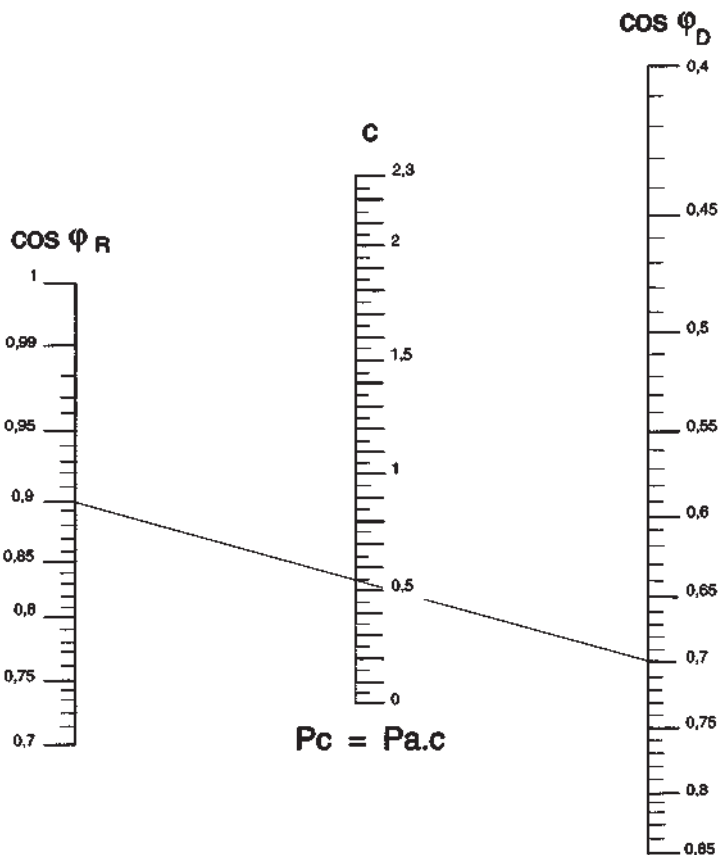

Example:

Electrical input (active)  $P_a$  motor = 20 [kW]

Available power factor  $\cos \phi_D = 0,7$

Required power factor  $\cos \phi_R = 0,9$

Multiplying factor (from nomogram)  $c = 0,54$

Phase-shift capacitor power  $P_c$

$P_c = P_a \times c = 20 \times 0,54 = 10,8$  [kVAR]

Exemples:

*Puissance absorbée (active) du moteur  $P_a = 20$  [kW]*

*Factor de puissance disponible  $\cos \phi_D = 0,7$*

*Factor de puissance recherchée  $\cos \phi_R = 0,9$*

*Facteur multiplicatif (du monogramme)  $c = 0,54$*

*Puissance des condensateurs  $P_c$*

*$P_c = P_a \times c = 20 \times 0,54 = 10,8$  [kVAR]*

Esempio:

Potenza attiva motore  $P_a = 20$  [kW]

Fattore di potenza disponibile  $\cos \phi_D = 0,7$

Fattore di potenza richiesto  $\cos \phi_R = 0,9$

Fattore moltiplicativo da nomogramma  $c = 0,54$

Potenza del condensatore di rifasamento  $P_c$

$P_c = P_a \times c = 20 \times 0,54 = 10,8$  [kVAR]

Accessories  
Accessoires  
Accessori

DCL Low level safety device  
DCL Dispositif pour défaut d'eau et contrôle niveau  
DCL Dispositivo contro la marcia a secco e controllo del livello

The conductivity electronic device DCL, is used for monitoring the levels of conductive liquids in wells, tanks or reservoirs.

In the case of minimum and maximum level control (prevention of dry running and automatic reset of the electric pump), the relay is at rest until the liquid reaches the upper level.

At this point the relay starts working thereby exciting the remote control switch coil (causing the electric pump to start and keeps this state until the liquid drows down below the minimum level.

During minimum level checking (prevention of dry running) relay remains constantly excited if pumped liquids is available.

Relay is not excited when there is no liquid or voltage lacks.

If so, relay must be manually reset.

*Le dispositif électroniques à conductivité DCL, sert à relever ou à contrôler les niveau du liquide conducteur dans les puits, les baches ou les réservoirs.*

*En cas de contrôle du niveau minimum ou maximum (protection contre la marche à sec et remise en marche automatique de l'électropompe), le relais se maintient en situation de repos tant que le liquide n'a pas atteint le niveau supérieur.*

*A ce point, le relais excite la bobine du télérupteur (qui provoque le démarrage de l'électropompe) et la maintient jusqu'à ce que le liquide descend sous le niveau minimum.*

*Quand on va vérifier le niveau minimum (protection contre la marche à sec) le relais reste toujours excité en présence du liquide pompé. Il n'est pas excité en absence du liquide ou quand la tension manque. Dans cette occasion le relais doit être réarmé manuellement.*

I dispositivo elettronico a conduttività DCL, serve a rilevare o controllare i livelli dei liquidi conduttivi in pozzi, vasche o serbatoi.

Nel caso di controllo di minimo e massimo livello (protezione contro la marcia a secco e riavviamento automatico della elettropompa), il relè si mantiene in stato di riposo fintanto che il liquido non ha raggiunto il livello superiore.

A questo punto, il relè entra in conduzione eccitando la bobina del teleruttore (che provoca, tramite l'apparecchiatura elettrica, l'avviamento dell'elettropompa) e mantiene tale stato finchè il liquido non scende sotto in livello minimo.

Nel caso di semplice controllo di minimo livello (protezione contro la marcia a secco), il relè rimane costantemente eccitato in presenza del liquido diseccitandosi in assenza di questo o per mancanza di tensione e deve essere riarmato manualmente.

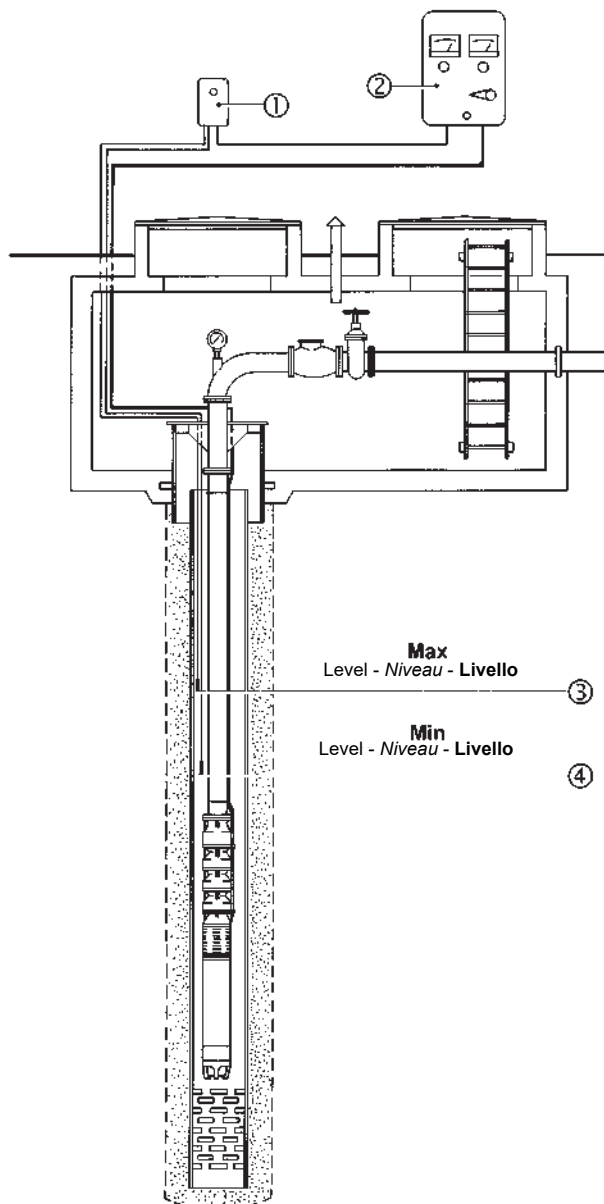

- 1) Low level safety device
- 2) Electric equipment
- 3) Maximum level electric probe
- 4) Minimum level electric probe

- 1) Dispositif complet pour défaut d'eau
- 2) Appareillage électrique
- 3) Sondes électriques au max. de niveau
- 4) Sondes électriques au min. de niveau

- 1) Dispositivo contro la marcia a secco
- 2) Apparecchiatura elettrica
- 3) Sonda elettrica max. livello
- 4) Sonda elettrica min. livello



T-412 Temperature monitoring device for submersed electric motors  
T-412 Appareillage de contrôle de la température des moteurs électriques immergés  
T-412 Apparecchiatura di controllo temperatura motori elettrici sommersi

T412 monitors the temperature inside the electric motor.

L'appareillage T412 sert à contrôler la température interne du moteur électrique.

L'apparecchiatura T412, serve a monitorare la temperatura interna del motore elettrico.

Connected to the PT100 probe (housed in the electric motor), it is able to read operating temperatures from 0-200[°C].  
T412 is supplied without a setting.

Branché à la sonde PT100 (logée à l'intérieur du moteur électrique) il permet la lecture de la température de fonctionnement entre 0-200[°C].  
L'appareillage T412 est fourni sans réglage.

Collegata alla sonda PT100 (alloggiata all'interno del motore elettrico) permette la lettura della temperatura di funzionamento tra 0-200[°C].  
L'apparecchiatura T412 viene fornita senza il settaggio.

How to make the setting:

- Start the electric pump and set it to the operating point with the highest power input. The internal temperature will rise progressively and will be monitored by the probe. When it has reached full rate (this may take up to 2 hours, depending on the motor), the temperature reading will stabilize.
- Once the temperature has become stable, select a value equal to the temperature reading +3[°C] for the first alarm setting. The alarm must record the excess temperature so as to produce documentation upon the first inspection;
- The setting for the second alarm, which must stop the motor, must equal the temperature reading +6[°C] the excess temperature recording can be automatic, but must occur with a delay of at least 15 minutes from the stopping action or when the internal temperature of the motor is 20[°C] less than the alarm temperature setting;  
ACTIVATION OF THE 2nd ALARM, WHICH STOPS THE MOTOR, WILL OCCUR WHEN:
  - There is an overload
  - There is a poor cooling action
  - There are too frequent starts

Mode de réglage :

- Mettre l'électropompe en marche et se placer dans le point de travail où la puissance absorbée est la plus élevée, la température interne augmentera progressivement et sera relevée par la sonde. Au régime établi (deux heures peuvent s'écouler, suivant le type de moteur) la température lue se stabilisera.
- Quand la température est stable, régler la première alarme à une valeur égale à la température lue +3[°C]., l'alarme doit enregistrer le dépassement pour en faire l'acquisition au premier contrôle;
- La deuxième alarme, qui doit commander l'arrêt du moteur, devra être étalonnée à une valeur égale à la température lue +6[°C]; le redémarrage, avec enregistrement du dépassement, peut être automatique mais doit avoir lieu avec un retard, par rapport à l'arrêt, d'au moins 15 minutes ou à une température interne du moteur inférieure de 20[°C] par rapport à la température de réglage de l'alarme.  
L'INTERVENTION DE LA 2<sup>e</sup> ALARME, AVEC ARRÊT DU MOTEUR, SE PRODUIT:
  - En cas de surcharge ;
  - En cas de refroidissement insuffisant;
  - En cas de démarrages trop fréquents.

Modalità per il settaggio:

- Avviare l'elettropompa e posizionarsi nel punto di lavoro a maggiore potenza assorbita, la temperatura nel suo interno crescerà progressivamente e verrà monitorata dalla sonda. A regime (a seconda del motore possono trascorrere fino a 2 ore) la temperatura letta si stabilizzerà.
- A lettura stabile della temperatura tarare il primo allarme ad un valore pari alla temperatura letta +3[°C], l'allarme deve registrare il superamento per averne documentazione alla prima ispezione;
- Il secondo allarme, che deve comandare l'arresto del motore, dovrà essere tarato ad un valore pari alla temperatura letta +6[°C]; il riavviamento, con registrazione del superamento, può essere automatico ma deve avvenire con un ritardo dall'arresto di almeno 15 minuti o a una temperatura interna del motore inferiore di 20[°C] rispetto alla temperatura settata di allarme;  
L'INTERVENTO DEL 2° ALLARME, CON ARRESTO DEL MOTORE, AVVIENE QUANDO :
  - C'è un sovraccarico
  - C'è uno scarso raffreddamento
  - Ci sono frequenti avviamenti

With the motor rotor wound in:

- In PVC, the maximum temperature setting of the second alarm must be 58[°C]
- In PE2+PA, the maximum temperature setting of the second alarm must be 75[°C].  
This device can also be used for monitoring the temperature of bearings, lubricants, in surface electric motors and machinery in general.  
The device complies with electromagnetic compatibility standards CEI EN-50081-2 and 50082-2.  
Dimensions: 48\*96 [mm] DIN 43700  
depth:130 [mm].

Avec moteur à rotor bobiné:

- En PVC, la température maximum de réglage de la deuxième alarme est de 58[°C].
- En PE2+PA, la température maximum de réglage de la deuxième alarme est de 75[°C].  
Ce dispositif pourra aussi être utilisé pour contrôler les températures des roulements, des lubrifiants, dans les moteurs électriques de surface et dans les machines en général.  
L'appareillage est conforme aux normes de compatibilité électromagnétique CEI EN-50081-2 et 50082-2.  
Dimensions: 48\*96 [mm] DIN 43700  
profondeur: 130 [mm].

Con il motore avvolto :

- In PVC la massima temperatura di settaggio del secondo allarme potrà essere di 58[°C]
- In PE2+PA la massima temperatura di settaggio del secondo allarme potrà essere di 75[°C].  
Tale dispositivo potrà essere utilizzato anche per monitorare le temperature dei cuscinetti, dei lubrificanti, nei motori elettrici di superficie e nelle macchine operatrici in generale.  
L'apparecchiatura rispetta le norme di compatibilità elettromagnetica CEI EN-50081-2 e 50082-2.  
Dimensioni : 48\*96 [mm] DIN 43700  
profondità: 130 [mm].

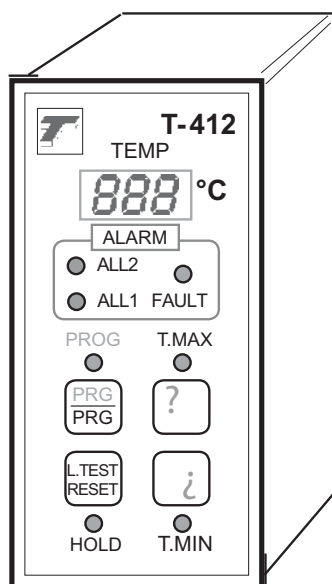

T-412

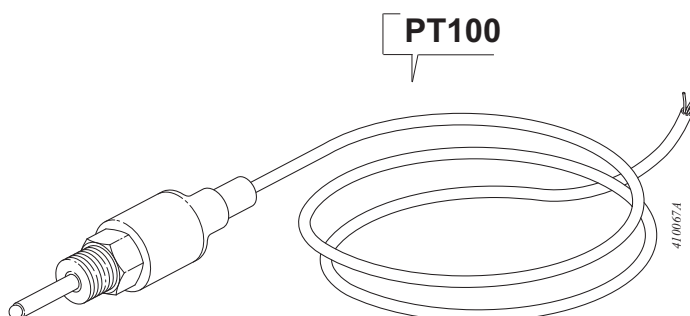

PT100

410067A

Technical data  
Donnes techniques  
Dati tecnici

## MEI = 0.4 for Multistage Submersible 2900rpm

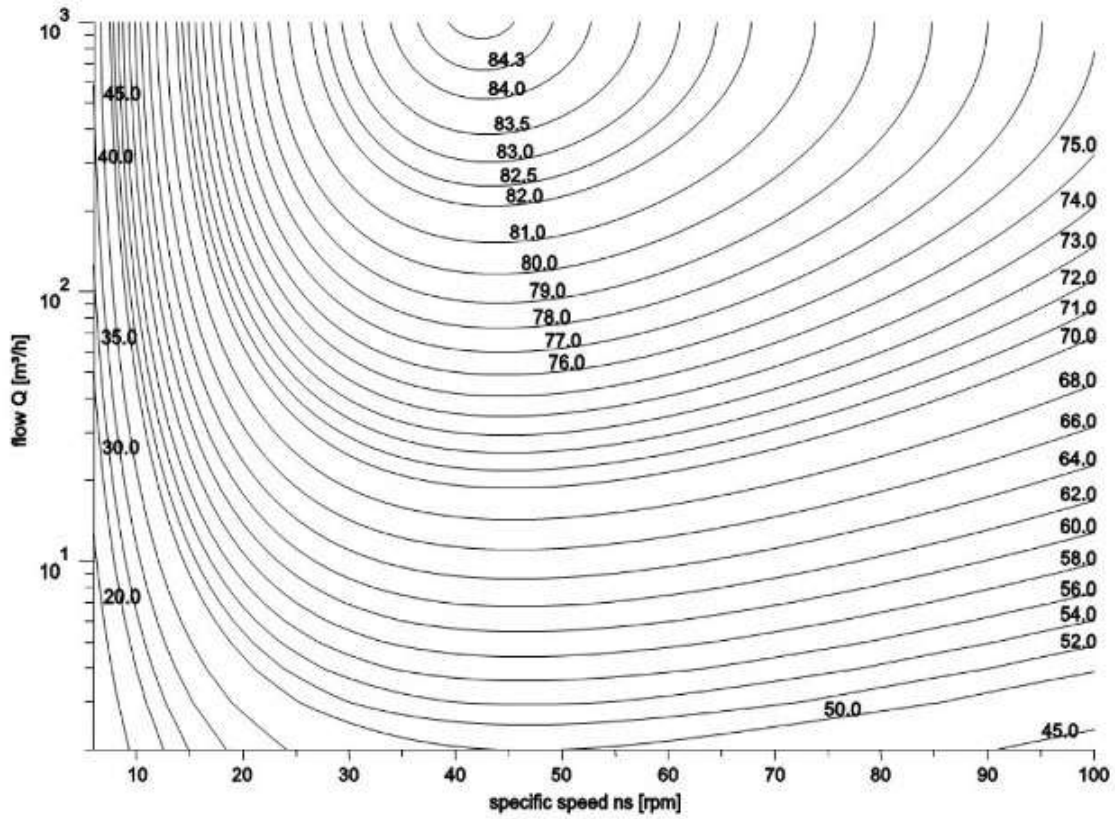

## MEI = 0.7 for Multistage Submersible 2900 rpm

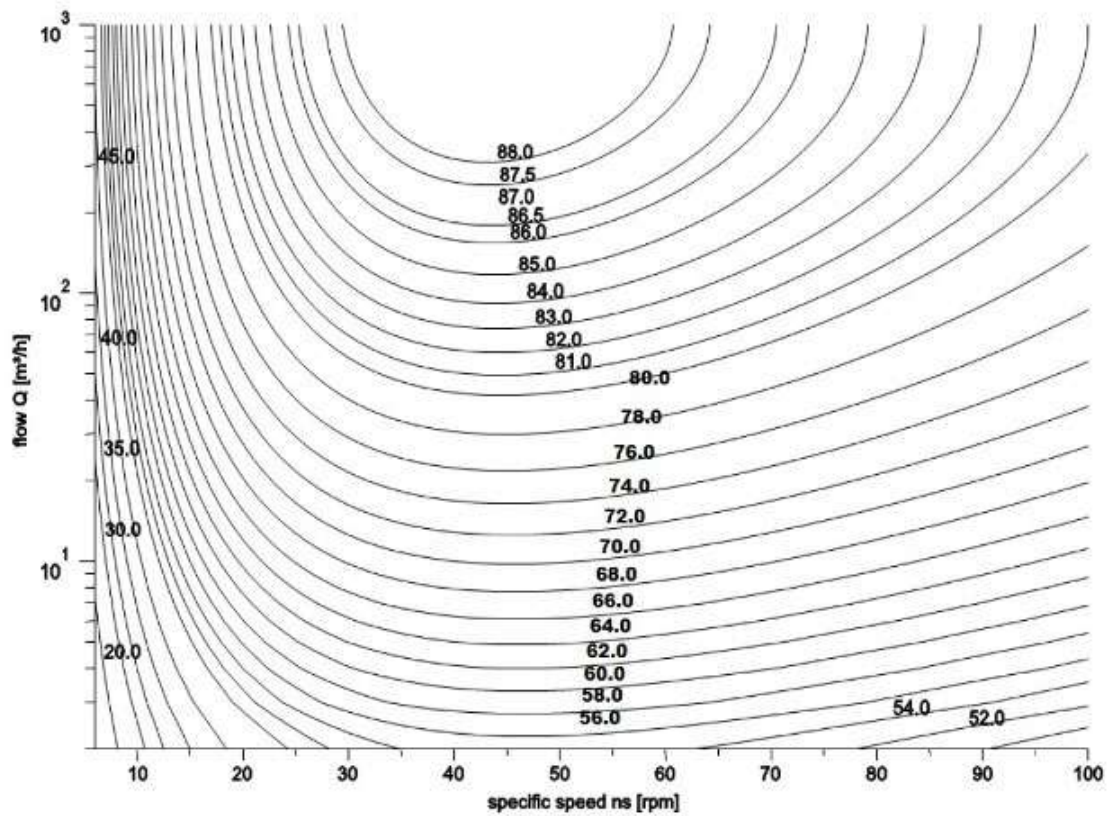



**caprari**

The dimensions have an indicative value. Executive drawing will be supplied on request upon order.  
CAPRARI S.p.A. reserves the right to make changes to improve its products at any time and without any notice

*Les dimensions sont fournies à titre indicatif. Le plan bon pour exécution sera fourni sur demande au moment de la commande.  
CAPRARI S.p.A. se réserve la faculté d'apporter des modifications visant à améliorer ses propres produits à tout moment et sans aucun préavis.*

**Le dimensioni hanno valore indicativo. Il disegno esecutivo sarà fornito su richiesta in fase d'ordine.  
CAPRARI S.p.A. si riserva facoltà di apportare modifiche atte a migliorare i propri prodotti in qualsiasi momento e senza preavviso alcuno.**