

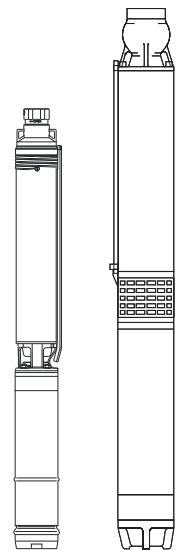

ELECTRIC BOREHOLE PUMPS
ELECTROPOMPES IMMERGEES
ELETTROPOMPE SOMMERSE

E4 - 6

Poles 2
Pôles 50 Hz
Poli



caprari

pumping power



	Page - Page - Pagina
Key to codes; <i>Explication des désignations</i> ; Esemplificazione delle sigle	3
Pump construction and materials; <i>Construction de la pompe et matériels</i> ; Costruzione pompa e materiali	4
Motor construction and materials; <i>Construction du moteur et matériels</i> ; Costruzione motore e materiali	7
General notes about the wet end; <i>Remarques générales partie hydraulique</i> ; Note generali parte idraulica	10
Motor general remarks; <i>Notes générales moteur</i> ; Note generali motore	11
Performance ranges; <i>Champs de performances</i> ; Campi di prestazioni	13
Pumps operating data, dimensions and weights; <i>Caractéristiques de fonctionnement, dimensions et poids électropompes</i> ; Caratteristiche di funzionamento, dimensioni e pesi elettropompe	15
Friction losses; <i>Pertes de charge</i> ; Perdite di carico	45
Motor operating data, dimensions and weights; <i>Caractéristiques de fonctionnement, dimensions et poids moteurs</i> ; Caratteristiche di funzionamento, dimensioni e pesi motori	46
Dynamic momentum of the wet end; <i>Moment dynamique partie hydraulique</i> ; Momento dinamico parte idraulica	53
Dynamic momentum of the motor; <i>Moment dynamique moteur</i> ; Momento dinamico motore	54
Feeding cables; <i>Câbles d'alimentation</i> ; Cavi di alimentazione	55
Generator power; <i>Puissance du generateur</i> ; Potenza del generatore	59
Common electric formulae; <i>Formules d'usage commun</i> ; Formule di uso comune	60
Electrical tolerances; <i>Tolérances électriques</i> ; Tolleranze elettriche	67
Reactive power compensation; <i>Compensation de la puissance reactive</i> ; Compensazione della potenza reattiva	69
Accessories; <i>Accessoires</i> ; Accessori	70
Technical data; <i>Donnes techniques</i> ; Dati tecnici	72

1) Electric pump code: - Désignation de l'électropompe: - Sigla elettropompa:

Ex. - Ex. - Es.
E4XED 25/31 + MCK 43-8V **E6XPD 52/3A + MAC65A-8V**
E4XPD 60/13 + MCK 455-8V
E6XD 20/30 + MAC 65A - 8V
E6XDB 40/60 + MAC650B-8V

2) Examples of wet end identification codes - Identification du sigle des partie hydraulique - Esemplificazione sigle parti idrauliche

E4XED 25-4/31-V: E4X ED 25 -4 /31 -V
E4X = Series - Série - Serie _____
ED = Desert - Desert - Desert _____
25 = Identification wet number - Numero identification hydraulique - Numero di identificazione idraulica _____
-4 = Coupling flange motor 4" - Bride d'accouplement moteur 4" - Flangia accoppiamento motore 4" _____
/31 = Number of stages - Nombre d'étages- Numero degli stadi _____
-V = Unit used at 50 Hz - Ensemble avec utilization a 50 Hz - Gruppo con impiego a 50 Hz _____

E6XD 20-6/30-V: E 6 XD 20 -6 /30 -V
E = Series - Série - Serie _____
6 = DN in inch - DN en pouces - DN in pollici _____
XD = Desert - Desert - Desert _____
20 = Identification wet number - Numero identification hydraulique - Numero di identificazione idraulica _____
-6 = Coupling flange motor 6" - Bride d'accouplement moteur 6" - Flangia accoppiamento motore 6" _____
/30 = Number of stages - Nombre d'étages- Numero degli stadi _____
-V = Unit used at 50 Hz - Ensemble avec utilization a 50 Hz - Gruppo con impiego a 50 Hz _____

E6XDB 40-6/60-V: E 6 XD B 40 -6 /60 -V
E = Series - Série - Serie _____
6 = DN in inch - DN en pouces - DN in pollici _____
XD = Desert - Desert - Desert _____
B = Intermediate casing construction - Version avec support intermediaire - Versione con supporto intermedio _____
40 = Identification wet number - Numero identification hydraulique - Numero di identificazione idraulica _____
-6 = Coupling flange motor 6" - Bride d'accouplement moteur 6" - Flangia accoppiamento motore 6" _____
/60 = Number of stages - Nombre d'étages- Numero degli stadi _____
-V = Unit used at 50 Hz - Ensemble avec utilization a 50 Hz - Gruppo con impiego a 50 Hz _____

E4XPD 60-4/13-W: E4X PD 60 -4 /13 -W
E4X = Series - Série - Serie _____
PD = Extra Performance Desert _____
60 = Identification wet number - Numero identification hydraulique - Numero di identificazione idraulica _____
-4 = Coupling flange motor 4" - Bride d'accouplement moteur 4" - Flangia accoppiamento motore 4" _____
/13 = Number of stages - Nombre d'étages- Numero degli stadi _____
-W = Unit used at 50/60 Hz - Ensemble avec utilization a 50/60 Hz - Gruppo con impiego a 50/60 Hz _____

E6XPD 52-6/3A-V: E 6 XPD 52 -6 /3 A -V
E = Series - Série - Serie _____
6 = DN in inch - DN en pouces - DN in pollici _____
XPD = Extra Performance Desert _____
52 = Identification wet number - Numero identification hydraulique - Numero di identificazione idraulica _____
-6 = Coupling flange motor 6" - Bride d'accouplement moteur 6" - Flangia accoppiamento motore 6" _____
/3 = Number of stages - Nombre d'étages- Numero degli stadi _____
A = Impeller trimming - Rognage roue - Riduzione girante _____
-V = Unit used at 50 Hz - Ensemble avec utilization a 50 Hz - Gruppo con impiego a 50 Hz _____

3) Examples of submersible motor identification codes - Identification du sigle des moteurs immergés - Esemplificazione sigle motori sommersi

MCK43 -8 : MC K 4 3 -8
MC = Submersible motor - Moteur immergé - Motore sommerso _____
K = Axial thrust - Poussée axiale - Spinta assiale _____
4 = Nominal diameter in inches - Diamètre nominal en pouces- Diametro nominale in pollici _____
3 = Nominal power in CV - Puissance nominale en CV - Potenza nominale in CV _____
-8 = Constructional features of electric motor - Caractéristiques de fabrication moteur électrique - Caratteristiche costruttive motore elettrico _____

MCR455 -8 MC R 4 55 -8
MC = Submersible motor - Moteur immergé - Motore sommerso _____
R = Axial thrust - Poussée axiale - Spinta assiale _____
4 = Nominal diameter in inches - Diamètre nominal en pouces- Diametro nominale in pollici _____
55 = Nominal power in CV - Puissance nominale en CV - Potenza nominale in CV _____
-8 = Constructional features of electric motor - Caractéristiques de fabrication moteur électrique - Caratteristiche costruttive motore elettrico _____

MAC65/3A-8 : MAC 6 5 /3 A -8
MAC = Submersible motor - Moteur immergé - Motore sommerso _____
6 = Nominal diameter in inches - Diamètre nominal en pouces- Diametro nominale in pollici _____
5 = Nominal power in CV - Puissance nominale en CV - Potenza nominale in CV _____
/3 = Generational code - Code générationnel - Codice generazionale _____
A = Hi Tech _____
-8 = Constructional features of electric motor - Caractéristiques de fabrication moteur électrique - Caratteristiche costruttive motore elettrico _____

MAC650/3B-8 : MAC 6 50 /3 B -8
MAC = Submersible motor - Moteur immergé - Motore sommerso _____
6 = Nominal diameter in inches - Diamètre nominal en pouces- Diametro nominale in pollici _____
50 = Nominal power in CV - Puissance nominale en CV - Potenza nominale in CV _____
/3 = Generational code - Code générationnel - Codice generazionale _____
B = Hi Tech Desert _____
-8 = Constructional features of electric motor - Caractéristiques de fabrication moteur électrique - Caratteristiche costruttive motore elettrico _____

E4XED E4XPD

E4XED15
 E4XED20
 E4XED25
 E4XED30
 E4XED35

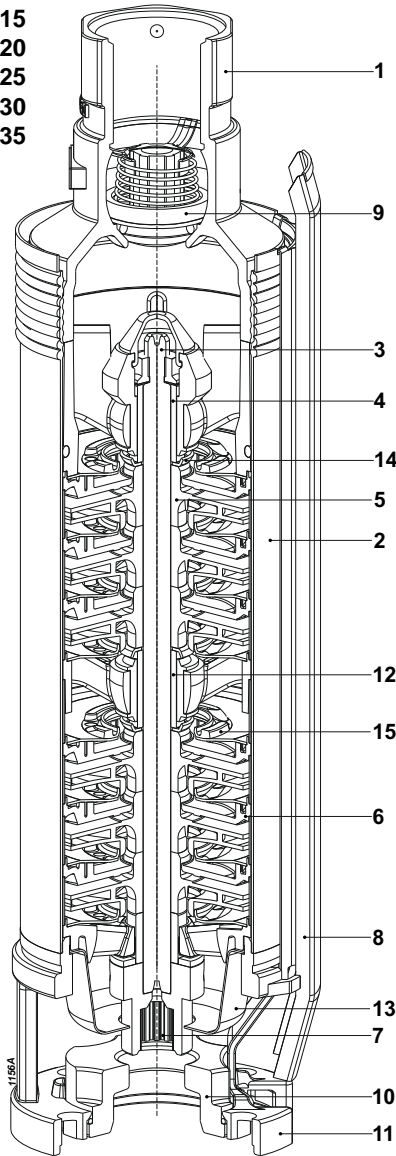

E4XED40
 E4XED50
 E4XPD60

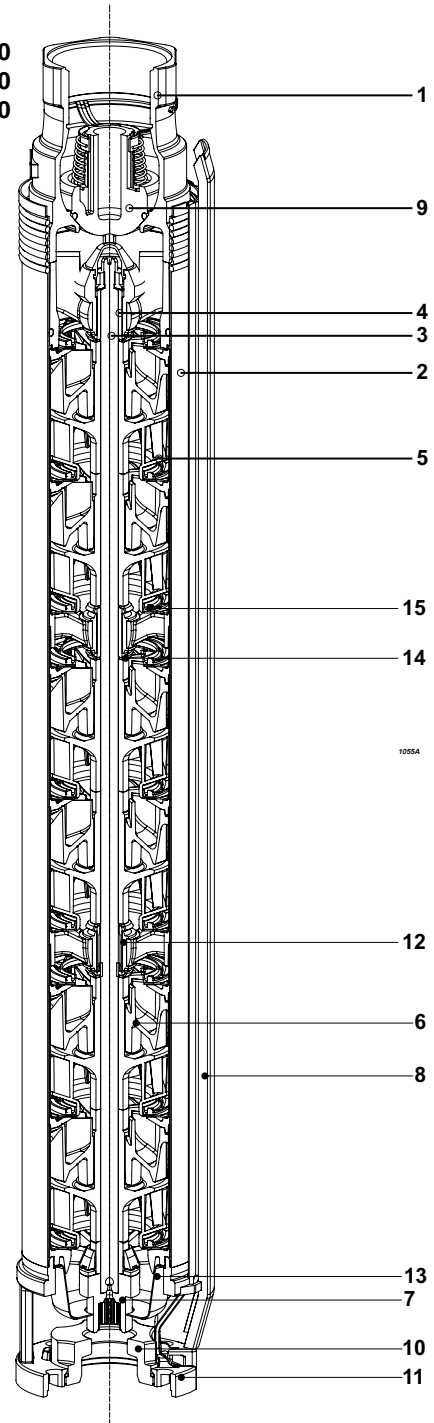

Pos.	Parts	Materials	Nomenclature	Matériaux	Nomenclatura	Materiale
1	Valve body	Stainless steel	Corps du clapet	Acier inox	Corpo valvola	Acciaio inox
2	Casing	Stainless steel	Chemise	Acier inox	Mantello	Acciaio inox
3	Shaft	Stainless steel	Arbre	Acier inox	Albero	Acciaio inox
4 (12)	Shaft sleeve	Aluminium oxide	Entretoise d'arbre	Alumine	Bussola albero	Allumina
5	Impeller	Technopolymer	Roue	Polymère technique	Girante	Tecnopolimero
6	Diffuser	Technopolymer	Diffuseur	Polymère technique	Diffusore	Tecnopolimero
7	Box coupling	Stainless steel	Accouplement a manchon	Acier inox	Manicotto di trasmissione	Acciaio inox
8	Cable guard	Stainless steel	Goutier protectif	Acier inox	Tegolo di protezione cavi	Acciaio inox
9	Conical valve	Technopolymer	Soupape du clapet	Polymère technique	Clapet	Tecnopolimero
10	Defender®	-	Defender®	-	Defender®	-
11	Suction cover	Stainless steel	Pièce d'aspiration	Acier inox	Supporto aspirazione	Acciaio inox
13	Strainer	Stainless steel	Crepine	Acier inox	Succheruola	Acciaio inox
14	Sand guard	Stainless steel	Para-sable	Acier inox	Parasabbia	Acciaio inox
15	Intermediate plate	Stainless steel/rubber	Disque intermédiaire	Acier inox/caoutchouc	Disco intermedio	Acciaio inox/gomma

Bolts and nuts in stainless steel.

Visserie en acier inox

Bulloneria in acciaio inox

Pump construction and materials
 Construction de la pompe et matériaux
 Costruzione pompa e materiali

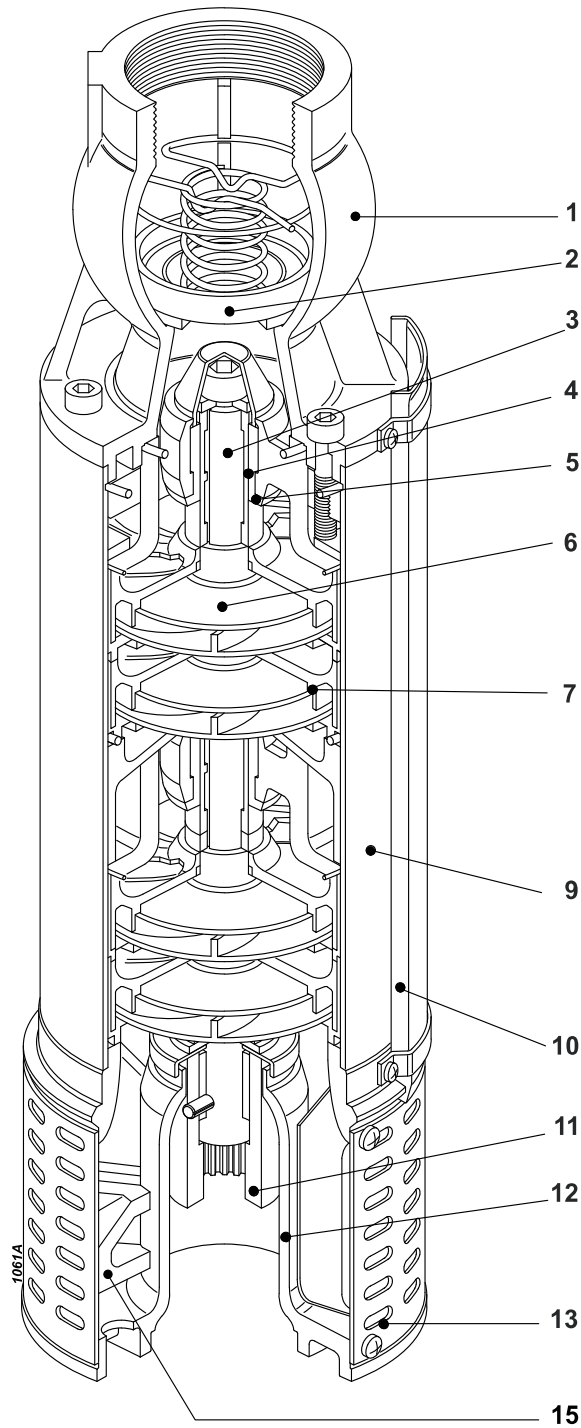

Pos.	Parts	Materials	Nomenclature	Matériaux	Nomenclatura	Materiale
1	Valve casing	Stainless steel	Corps du clapet	Acier inox	Corpo valvola	Acciaio inox
2	Conical valve	Stainless steel	Souape du clapet	Acier inox	Clapet	Acciaio inox
3	Pump shaft	Stainless steel	Arbre de pompe	Acier inox	Albero	Acciaio inox
4	Shaft sleeve	Stainless steel	Entretoise d'arbre	Acier inox	Bussola albero	Acciaio inox
5	Shaft bearing bush	Rubber	Coussinet arbre pompe	Caoutchouc	Cuscinetto albero	Gomma
6	Impeller	Technopolymer	Roue	Polymère technique	Girante	Tecnopolimero
7	Diffuser	Technopolymer	Diffuseur	Polymère technique	Diffusore	Tecnopolimero
9	Stage casing	Stainless steel	Corps d'étage	Acier inox	Mantello	Acciaio inox
10	Cable guard	Stainless steel	Gouttière de protection	Acier inox	Tegolo protezione cavi	Acciaio inox
11	Coupling	Stainless steel	Accouplement rigide	Acier inox	Giunto rigido	Acciaio inox
12	Suction casing	Stainless steel	Pièce d'aspiration	Acier inox	Supporto aspirazione	Acciaio inox
13	Strainer	Stainless steel	Crepine	Acier inox	Succheruola	Acciaio inox
15	Defender®	-	Defender®	-	Defender®	-

Bolts and nuts in stainless steel

Visserie en acier inox

Bulloneria in acciaio inox

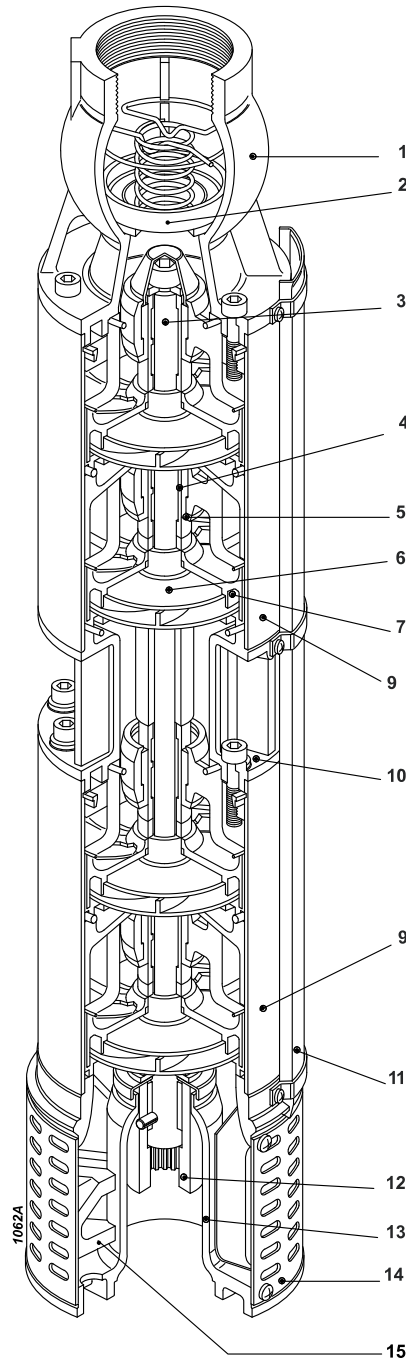

Pos.	Parts	Materials	Nomenclature	Matériaux	Nomenclatura	Materiale
1	Valve casing	Stainless steel	Corps du clapet	Acier inox	Corpo valvola	Acciaio inox
2	Conical valve	Stainless steel	Clapet	Acier inox	Clapet	Acciaio inox
3	Pump shaft	Stainless steel	Arbre de pompe	Acier inox	Albero	Acciaio inox
4	Shaft sleeve	Stainless steel	Entretoise d'arbre	Acier inox	Bussola albero	Acciaio inox
5	Shaft bearing bush	Rubber	Coussinet arbre pompe	Caoutchouc	Cuscinetto albero	Gomma
6	Impeller	Technopolymer	Roue	Polymère technique	Girante	Tecnopolimero
7	Diffuser	Technopolymer	Diffuseur	Polymère technique	Diffusore	Tecnopolimero
9	Stage casing	Stainless steel	Corps d'Etage	Acier inox	Mantello	Acciaio inox
10	Intermediate bearing	Stainless steel	Palier intermediaire	Acier inox	Supporto intermedio	Acciaio inox
11	Cable guard	Stainless steel	Gouttière de protection	Acier inox	Tegolo protezione cavi	Acciaio inox
12	Coupling	Stainless steel	Accouplement rigide	Acier inox	Giunto rigido	Acciaio inox
13	Suction cover	Stainless steel	Pièce d'aspiration	Acier inox	Supporto aspirazione	Acciaio inox
14	Strainer	Stainless steel	Crepine	Acier inox	Succheruola	Acciaio inox
15	Defender®	-	Defender®	-	Defender®	-

Bolts and nuts in stainless steel.

Visserie en acier inox

Bulloneria in acciaio inox

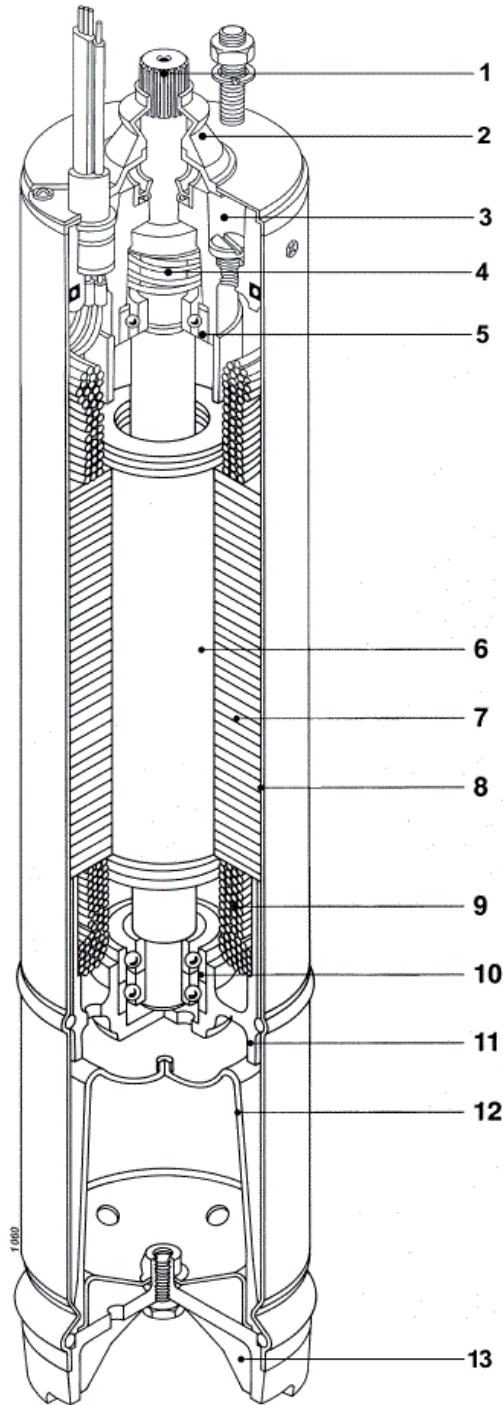

Pos.	Parts	Materials	Nomenclature	Matériaux	Nomenclatura	Materiale
1	Shaft	Stainless steel	Arbre	Acier inox	Albero	Acciaio inox
2	Sand guard	Rubber	para-sable	Caoutchouc	Parasabbia	Gomma
3	Upper bracket	Cast iron	Support supérieur	Fonte grise	Supporto superiore	Ghisa grigia
4	Mechanical seal	Silicon carbide/ceramic	Garniture mécanique	Carbure de silicium/céramique	Tenuta meccanica	Carburo di silicio/ceramica
4	Mechanical seal	Ceramic/graphite	Garniture mécanique	Céramique/graphite	Tenuta meccanica	Ceramica/grafite
5	Upper ball bearing	Steel	Roulement supérieur	Acier	Cuscinetto superiore	Acciaio
6	Rotor	Electrical steel	Rotor	Tôle magnétique	Rotore	Lamierino magnetico
7	Stator	Electrical steel	Stator	Tôle magnétique	Statore	Lamierino magnetico
8	Stator shell	Stainless steel	Chemise de stator	Acier inox	Camicia statore	Acciaio inox
9	Winding	Copper	Bobinage	Cuivre	Avvolgimento	Rame
10	Lower ball bearing	Steel	Roulement inférieur	Acier	Cuscinetto inferiore	Acciaio
11	Lower bracket	Aluminium	Support inférieur	Aluminium	Supporto inferiore	Alluminio
12	Diaphragm	Rubber	Membrane	Caoutchouc	Membrana	Gomma
13	Diaphragm cover (MC..405-41)	Stainless steel	Couvercle de membrane (MC..405-41)	Acier inox	Coperchio membrana (MC..405-41)	Acciaio inox
13	Diaphragm cover (MC..415-410)	Technopolymer	Couvercle de membrane (MC..415-410)	Polymère technique	Coperchio membrana (MC..415-410)	Tecnopolimero

Bolts and nuts in stainless steel.

Vissiere en acier inox

Bulloneria in acciaio inox

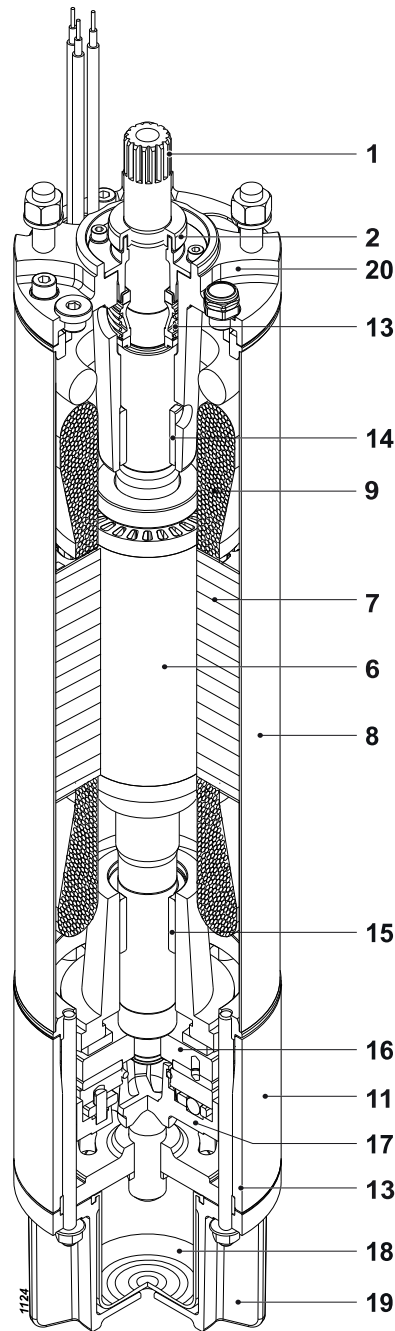

Pos.	Parts	Materials	Nomenclature	Matériaux	Nomenclatura	Materiale
1	Shaft	Stainless steel	Arbre	Acier inox	Albero	Acciaio inox
2	Sand guard	Rubber	para-sable	Caoutchouc	Parasabbia	Gomma
6	Rotor	Electrical steel	Rotor	Tôle magnétique	Rotore	Lamierino magnetico
7	Stator	Electrical steel	Stator	Tôle magnétique	Statore	Lamierino magnetico
8	Stator shell	Stainless steel	Chemise de stator	Acier inox	Camicia statore	Acciaio inox
9	Winding	PPC	Bobinage	PPC	Avvolgimento	PPC
11	Lower bracket	Cast iron	Support inférieur	Fonte grise	Supporto inferiore	Ghisa grigia
13	Mechanical seal	Silicon carbide/ silicon carbide	Garniture mécanique	Carbure de silicium/ carbure de silicium	Tenuta meccanica	Carburo di silicio/ Carburo di silicio
14-15	Bearing	Graphite	Coussinett	Graphite	Cuscinetto	Grafite
16	Thrust-bearing	Stainless steel/ Synthetic compound	Butée	Acier inox/Composé synthétique	Reggispinta	Acciaio inox/ Composito sintetico
17	Thrust-bearing foot slip	Cast iron	Support butée	Fonte grise	Supporto reggispinta	Ghisa grigia
18	Diaphragm	Rubber	Membrane	Caoutchouc	Membrana	Gomma
19	Diaphragm cover	Cast iron	Couvercle de membrane	Fonte grise	Coperchio membrana	Ghisa grigia
20	Upper bracket	Cast iron	Support supérieur	Fonte grise	Supporto superiore	Ghisa grigia

Bolts and nuts in stainless steel.

Visserie en acier inox

Bulloneria in acciaio inox

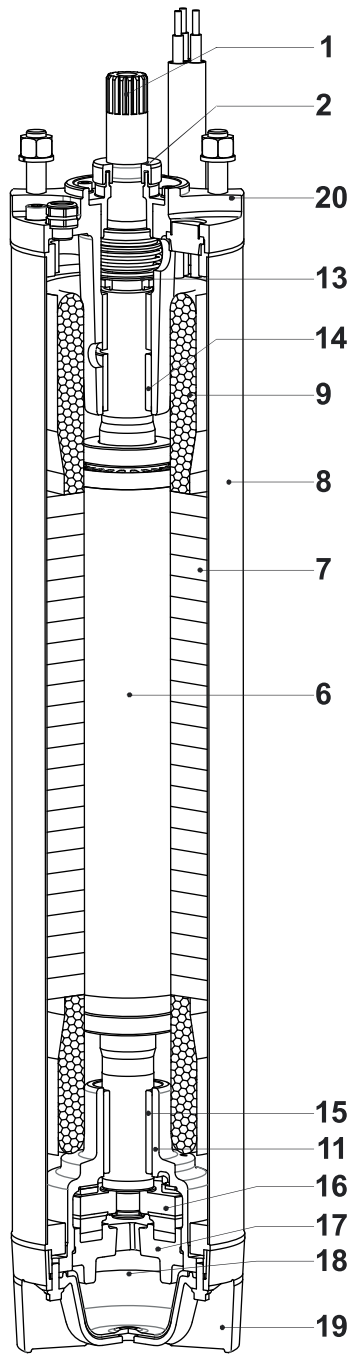

						
Pos.	Parts	Materials	Nomenclature	Matériaux	Nomenclatura	Materiale
1	Shaft	Stainless steel	Arbre	Acier inox	Albero	Acciaio inox
2	Sand guard	Rubber	para-sable	Caoutchouc	Parasabbia	Gomma
6	Rotor	Electrical steel	Rotor	Tôle magnétique	Rotore	Lamierino magnetico
7	Stator	Electrical steel	Stator	Tôle magnétique	Statore	Lamierino magnetico
8	Stator shell	Stainless steel	Chemise de stator	Acier inox	Camicia statore	Acciaio inox
9	Winding	Green wire	Bobinage	Green wire	Avvolgimento	Green wire
11	Lower bracket	Cast iron	Support inférieur	Fonte grise	Supporto inferiore	Ghisa grigia
13	Mechanical seal	Silicon carbide/ silicon carbide	Garniture mécanique	Carbure de silicium/ carbure de silicium	Tenuta meccanica	Carburo di silicio/ carburo di silicio
14-15	Bearing	Graphite	Coussinett	Graphite	Cuscinetto	Grafite
16	Thrust-bearing	Brass/ Synthetic compound	Butée	Laiton/ Composé synthétique	Reggispinta	Ottone/Composito sintetico
17	Thrust-bearing foot slip	Cast iron	Support butée	Fonte grise	Supporto reggispinta	Ghisa grigia
18	Diaphragm	Rubber	Membrane	Caoutchouc	Membrana	Gomma
19	Diaphragm cover	Technopolymer	Couvercle de membrane	Polymère technique	Coperchio membrana	Tecnopolimero
20	Upper bracket	Cast iron	Support supérieur	Fonte grise	Supporto superiore	Ghisa grigia

Bolts and nuts in stainless steel.

Visserie en acier inox

Bulloneria in acciaio inox

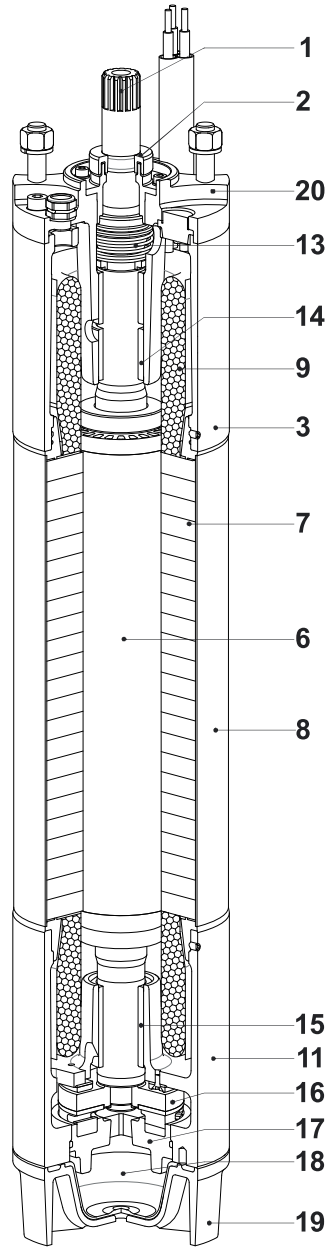

Pos.	Parts	Materials	Nomenclature	Matériaux	Nomenclatura	Materiale
1	Shaft	Stainless steel	Arbre	Acier inox	Albero	Acciaio inox
2	Sand guard	Rubber	para-sable	Caoutchouc	Parasabbia	Gomma
3	Upper cover	Cast iron	Couvercle supérieur	Fonte grise	Coperchio superiore	Ghisa grigia
6	Rotor	Electrical steel	Rotor	Tôle magnétique	Rotore	Lamierino magnetico
7	Stator	Electrical steel	Stator	Tôle magnétique	Statore	Lamierino magnetico
8	Stator shell	Stainless steel	Chemise de stator	Acier inox	Camicia statore	Acciaio inox
9	Winding	Green wire	Bobinage	Green wire	Avvolgimento	Green wire
11	Lower bracket	Cast iron	Support inférieur	Fonte grise	Supporto inferiore	Ghisa grigia
13	Mechanical seal	Silicon carbide/ silicon carbide	Garniture mécanique	Carbure de silicium/ carbure de silicium	Tenuta meccanica	Carburo di silicio/ Carburo di silicio
14-15	Bearing	Graphite	Coussinett	Graphite	Cuscinetto	Grafite
16	Thrust-bearing	Brass/Synthetic compound	Butée	Laiton/Composé synthétique	Reggispinta	Ottone/Composito sintetico
17	Thrust-bearing foot slip	Cast iron	Support butée	Fonte grise	Supporto reggispinta	Ghisa grigia
18	Diaphragm	Rubber	Membrane	Caoutchouc	Membrana	Gomma
19	Diaphragm cover	Cast iron	Couvercle de membrane	Fonte grise	Coperchio membrana	Ghisa grigia
20	Upper bracket	Cast iron	Support supérieur	Fonte grise	Supporto superiore	Ghisa grigia

Bolts and nuts in stainless steel.

Visserie en acier inox

Bulloneria in acciaio inox

- a) The normal construction version of  line submersible electric pumps is designed for lifting water chemically and mechanically non-aggressive for the components.
- b) Maximum content of solids, the same hardness and granulometry of silt:
 E4XED - E6XD 300 g/m³
- c) Maximum operating time when the outlet is closed and the pump is submersed: 3 min.
- d) The hydraulic performance characteristics were measured with 400 V powered motors, cold water (15°C) and atmospheric pressure (1 bar). They are guaranteed as conforming to standard UNI/ISO 9906 Grade 3B.
 The hydraulic characteristics of units coupled to MAC 6.../3B 6" motors are guaranteed as conforming to standard UNI/ISO 9906 Grade 2B.

The catalogue given data refer to liquids with a density of 1 kg/dm³ and kinematic viscosity of not more than 1 mm²/s, are comprehensive of friction losses in the check valves.

- e) UPON REQUEST
 - Pumps can be tested according to UNI/ISO 9906 Grade 2B.
 - Special executions can be supplied with:
 - for horizontal installation, if not usually foreseen.
- f) Extra performance:
 Pumps for specific applications with a high percentage of solids and sand:
 E4XPD60 - E6XPD52 450 g/m

- a) *Les électropompes immergées ligne , dans la version à fabrication standard, sont adaptées au relevage d'eau qui n'est pas chimiquement et mécaniquement agressive pour les matériaux des composants.*
- b) *Contenu maximum des substances solides de la dureté et la granulométrie du limon: E4XED - E6XD 300 g/m³*
- c) *Temps maximum de fonctionnement, à vanne fermée et pompe submergée: 3 min.*
- d) *Les caractéristiques hydrauliques de fonctionnement ont été mesurées avec des moteurs à 400 V, avec de l'eau froide (15° C) à une pression atmosphérique (1bar). Elles sont garanties conformes à la norme UNI/ISO 9906 Niveau 3B. Pour les groupes accouplés à des moteurs 6" MAC 6.../3B les caractéristiques hydrauliques sont garanties conformes à la norme UNI/ISO 9906 Niveau 2B.*

Les données du catalogue se réfèrent à un liquide pompé de densité de 1 kg/dm³ et avec une viscosité cinématique non supérieure à 1 mm²/s. Elles comprennent les pertes de charge dans les clapets de retenue.

- e) *SUR DEMANDE*
 - *Les pompes peuvent être testées selon les normes UNI/ISO 9906 Niveau 2B.*
 - *Nous pouvons fournir des exécutions spéciales:*
 - *pour installation horizontale si pas normalement prévue.*
- f) *Extra performance:*
Pompes pour applications spécifiques à haute teneur en solides et sable:
E4XPD60 - E6XPD52 450 g/m³.

- a) **Le elettropompe sommersa linea , nella normale versione costruttiva, sono adatte al sollevamento di acqua chimicamente e meccanicamente non aggressiva per i materiali dei componenti.**
- b) **Contenuto massimo di sostanze solide della durezza e granulometria del limo: E4XED - E6XD 300 g/m³**
- c) **Tempo massimo di funzionamento a bocca chiusa e pompa sommersa: 3 min.**
- d) **Le caratteristiche idrauliche di funzionamento sono state rilevate con motori alimentati a 400 V, con acqua fredda (15° C) alla pressione atmosferica (1bar). Vengono garantite secondo la norma UNI/ISO 9906 Grado 3B. Per i gruppi accoppiati a motori 6" MAC 6.../3B le caratteristiche idrauliche vengono garantite secondo la norma UNI/ISO 9906 Grado 2B.**

I dati di catalogo si riferiscono a liquidi con densità di 1 kg/dm³ e con viscosità cinematica non superiore a 1 mm²/s, e sono comprensivi delle perdite di carico nelle valvole di ritegno.

- e) **SU RICHIESTA**
 - **Possono essere collaudate secondo le norme UNI/ISO 9906 Grado 2B.**
 - **Possono essere fornite esecuzioni speciali:**
 - **per installazione in orizzontale, quando non già prevista.**
- f) **Extra performance:**
Pompe per applicazioni specifiche ad alto contenuto di solidi e sabbia:
E4XPD60 - E6XPD52 450 g/m³

Motor general remarks
Notes generales moteur
Note generali motore

- | | | |
|--|--|--|
| <p>a) Maximum submersion: 150 m
Speed of the water outside the jacket of the motor higher:
0,08 m/s for motors 4"
0,5 m/s for motors MPC6
0,5 m/s for motors MAC...A (5-40 cv)
0,5 m/s for motors MAC...B (50-60 cv)</p> <p>Max temperature liquid
MC4.. = 30°C
MPC6=40°(5,5 - 20 cv)
MPC6=35° (25 - 40 cv)
MPC6=30* (50 cv)</p> <p>MAC6...A=40° (5,5 - 20 cv)
MAC6...A=35° (25 - 40 cv)
MAC6...A=30° (50 cv)</p> <p>MAC6...B=45° (5,5 - 20 cv)
MAC6...B=40° (25 - 40 cv)
MAC6...B=35° (50 - 60 cv)</p> <p>b) STANDARD VERSION - THREE-PHASE/50 Hz supply voltage</p> <p>Direct starting:
MC/MAC/MPC...-8;
400 V for all power outputs
All the motors are fit for operation with an inverter, but in compliance with the following instructions:
a filter is to be provided between the motor and the inverter to keep the voltage gradient (contact the sales network).</p> <p>MAC6..
MAC6../3A
Submersible motor with high efficiency. (standard motor)</p> <p>c) VERSION ON REQUEST</p> <p>MPC6../2A
standard motor</p> <p>MPC6../K
Submersible motor with high efficiency</p> <p>MAC6...
MAC6../3B - /3C
Submersible motor specified for high temperature or for huge sand's content. For any further information please do not hesitate to contact our service network.</p> <p>MAC6../3C PLUS
Submersible motor specified for high temperature, high solid contents and the best solution in VSD applications.</p> <p>THREE-PHASE/50 Hz supply voltage
4" MC...-6 230V fino a 7,5 kW
6": MPC...-9 400/700 V up to 37 kW
MAC...-6 230 V up to 30 kW,
MAC...-7 230/400 V up to 37 kW
MAC...-9 400/700 V up to 45 kW</p> <p>In addition, motors can be supplied:
- for other voltages and frequencies
- single-phase motors
MC..M.-1 220/230 V up to 4 kW
MC..M.-2 230/240 V up to 4 kW
- with special materials for aggressive water</p> <p>d) Permissible variations on the stated supply voltages without brackets:
4";6": 230 V ± 10%
400 V ± 10%
single-phase motors 4 " : ± 5%
4"-6": for other voltages and frequencies ± 5%</p> <p>Tolerances on the operating data: according to the International Standards IEC 34-1.
Thermal probes on request with the same length as the power cables</p> | <p>a) Immersion maximum : 150 m
Vitesse de l'eau à l'extérieur de la chemise du moteur supérieure à:
0,08 m/s pour moteurs 4"
0,5 m/s pour moteurs MPC6
0,5 m/s pour moteurs MAC...A (5-40 cv)
0,5 m/s pour moteurs MAC...B (50-60 cv)</p> <p>Température Max liquide
MC4.. = 30°C
MPC6=40°(5,5 - 20 cv)
MPC6=35° (25 - 40 cv)
MPC6=30* (50 cv)</p> <p>MAC6...A=40° (5,5 - 20 cv)
MAC6...A=35° (25 - 40 cv)
MAC6...A=30° (50 cv)</p> <p>MAC6...B=45° (5,5 - 20 cv)
MAC6...B=40° (25 - 40 cv)
MAC6...B=35° (50 - 60 cv)</p> <p>b) EXECUTION STANDARD - Tension d'alimentation TRIPHASEE/50 Hz</p> <p>Démarrage direct :
MC/MAC/MPC...-8;
400 V pour toutes les puissances
Tous les moteurs sont adaptés au fonctionnement à variateur de fréquence mais d'après les prescriptions suivantes:
un filtre entre le moteur et le variateur de fréquence est à prévoir pour maintenir le gradient de tension (contacter le réseau de vente).</p> <p>MAC6..
MAC6../3A
Moteur submersible avec prestations élevées. (moteur standard)</p> <p>c) EXECUTION SUR DEMANDE</p> <p>MPC6../2A
moteur standard</p> <p>MPC6../K
Moteur submersible avec prestations élevées</p> <p>MAC6...
MAC6../3B - /3C
Moteur submersible spécifique pour utilisation à haute température ou à haut contenu de sable.
pour toute information complémentaire, n'hésitez pas à contacter notre réseau de vente.</p> <p>MAC6../3C PLUS
Moteur immergé pour l'utilisation aux températures élevées, à haute teneur de sable et meilleure solution pour le fonctionnement avec onduleur.</p> <p>Tension d'alimentation TRIPHASEE/50 Hz
4": MC...-6 230V fino a 7,5 kW
6": MPC...-9 400/700 V jusqu'à 37 kW
MAC...-6 230 V jusqu'à 30 kW,
MAC...-7 230/400 V jusqu'à 37 kW
MAC...-9 400/700 V jusqu'à 45 kW</p> <p>En outre, des moteurs peuvent être fournis :
- pour tensions et fréquences différentes
- monophasés
MC..M.-1 220/230 V jusqu'à 4 kW
MC..M.-2 230/240 V jusqu'à 4 kW
- avec matériaux spéciaux pour eau aggressive.</p> <p>d) Variations admises sur les tensions d'alimentation indiquées sans parenthèses :
4";6" : 230 V ± 10%
400 V ± 10%
monophasés 4" : ± 5%
4"-6" : pour tensions et fréquences différentes ± 5%</p> <p>Tolérances sur les caractéristiques de fonctionnement : selon les normes internationales IEC 34-1.
Sondes thermiques sur demande avec la même longueur que les câbles d'alimentation</p> | <p>a) Battente massimo: 150 m
Velocità dell'acqua all'esterno della camicia del motore superiore:
0,08 m/s per motori 4"
0,5 m/s per motori MPC6
0,5 m/s per motori MAC...A (5-40 cv)
0,5 m/s per motori MAC...B (50-60 cv)</p> <p>Temperatura Max liquido
MC4.. = 30°C
MPC6=40°(5,5 a 20 cv)
MPC6=35° (25 a 40 cv)
MPC6=30* (50 cv)</p> <p>MAC6...A=40° (5,5 a 20 cv)
MAC6...A=35° (25 a 40 cv)
MAC6...A=30° (50 cv)</p> <p>MAC6...B=45° (5,5 a 20 cv)
MAC6...B=40° (25 a 40 cv)
MAC6...B=35° (50 a 60 cv)</p> <p>b) ESECUZIONE STANDARD - Tensione di alimentazione TRIFASE/50 Hz</p> <p>Avviamento diretto:
MC/MAC/MPC...-8;
400V per tutte le potenze
Tutti i motori sono idonei al funzionamento con inverter ma secondo le seguenti prescrizioni:
tra inverter e motore aggiungere un filtro per attenuare il gradiente di tensione (contattare la rete di vendita)</p> <p>MAC6..
MAC6../3A
Motore sommerso ad alte prestazioni. (motore standard)</p> <p>c) ESECUZIONE DISPONIBILI</p> <p>MPC6../2A
motore standard</p> <p>MPC6../K
Motore sommerso per utilizzo ad alte Temperature.</p> <p>MAC6..
MAC6../3B - /3C
Motore sommerso per utilizzo ad alte temperature o alti contenuti di sabbia. Per ulteriori informazioni contattare la nostra rete di vendita</p> <p>MAC6../3C PLUS
Motore sommerso per utilizzo ad alte temperature, alti contenuti di sabbia e migliore soluzione per funzionamento con inverter.</p> <p>Tensione di alimentazione TRIFASE/50 Hz
4": MC...-6 230V fino a 7,5 kW
6": MPC...-9 400/700 V fino a 37 kW
MAC...-6 230 V fino a 30 kW,
MAC...-7 230/400 V fino a 37 kW
MAC...-9 400/700 V fino a 45 kW</p> <p>Possono inoltre essere forniti motori:
- per tensioni e frequenze diverse
- monofase
MC..M.-1 220/230 V fino a 4 kW
MC..M.-2 230/240 V fino a 4 kW
- con materiali speciali per acqua aggressiva.</p> <p>d) Variazioni ammesse sulle tensioni di alimentazione indicate senza parentesi:
4"; 6": 230 V ± 10%
400 V ± 10%
monofase 4" ± 5%
4"-6": per tensioni/frequenze diverse ± 5%</p> <p>Tolleranze sulle caratteristiche di funzionamento: secondo le Norme Internazionali IEC 34-1.</p> <p>Sonde termiche su richiesta con lunghezza uguale ai cavi di potenza.</p> |
|--|--|--|

Performance ranges
Champs de performances
Campi di prestazioni

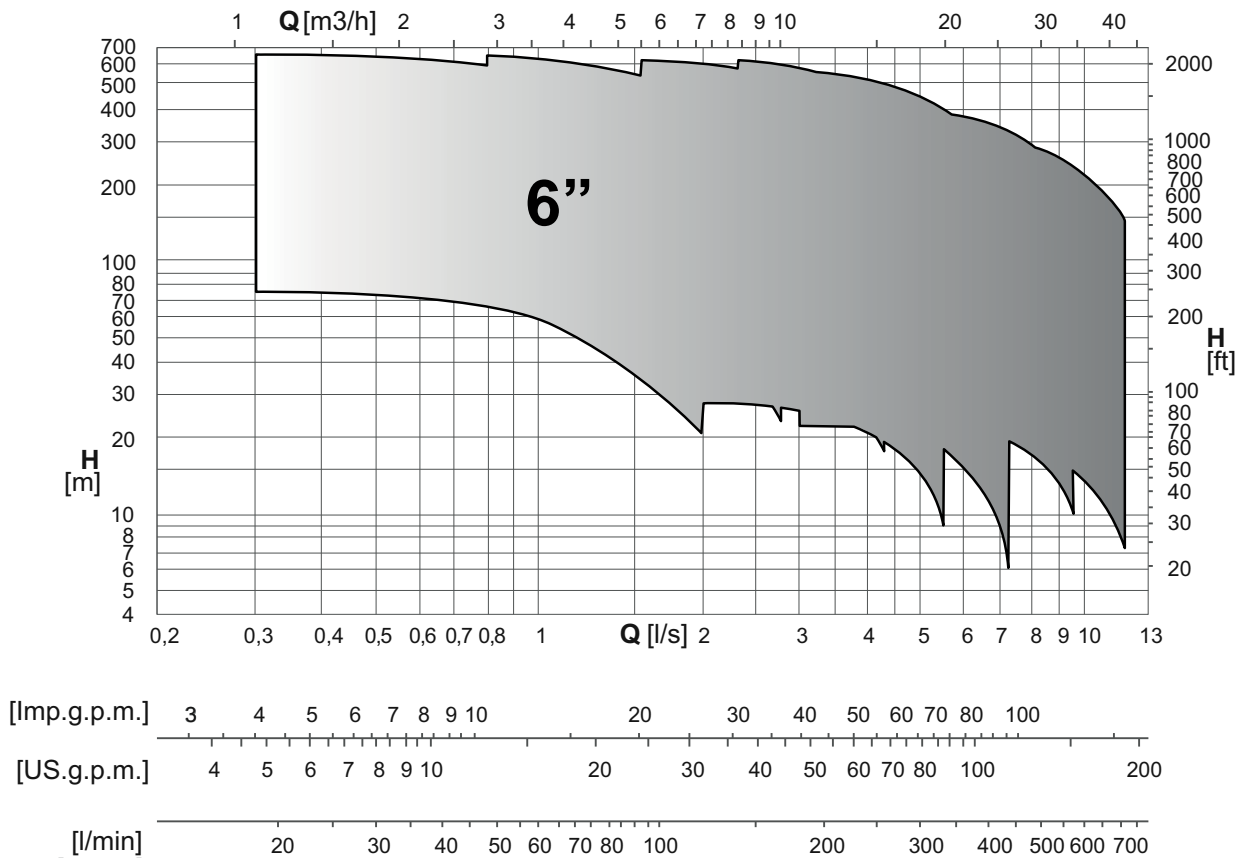
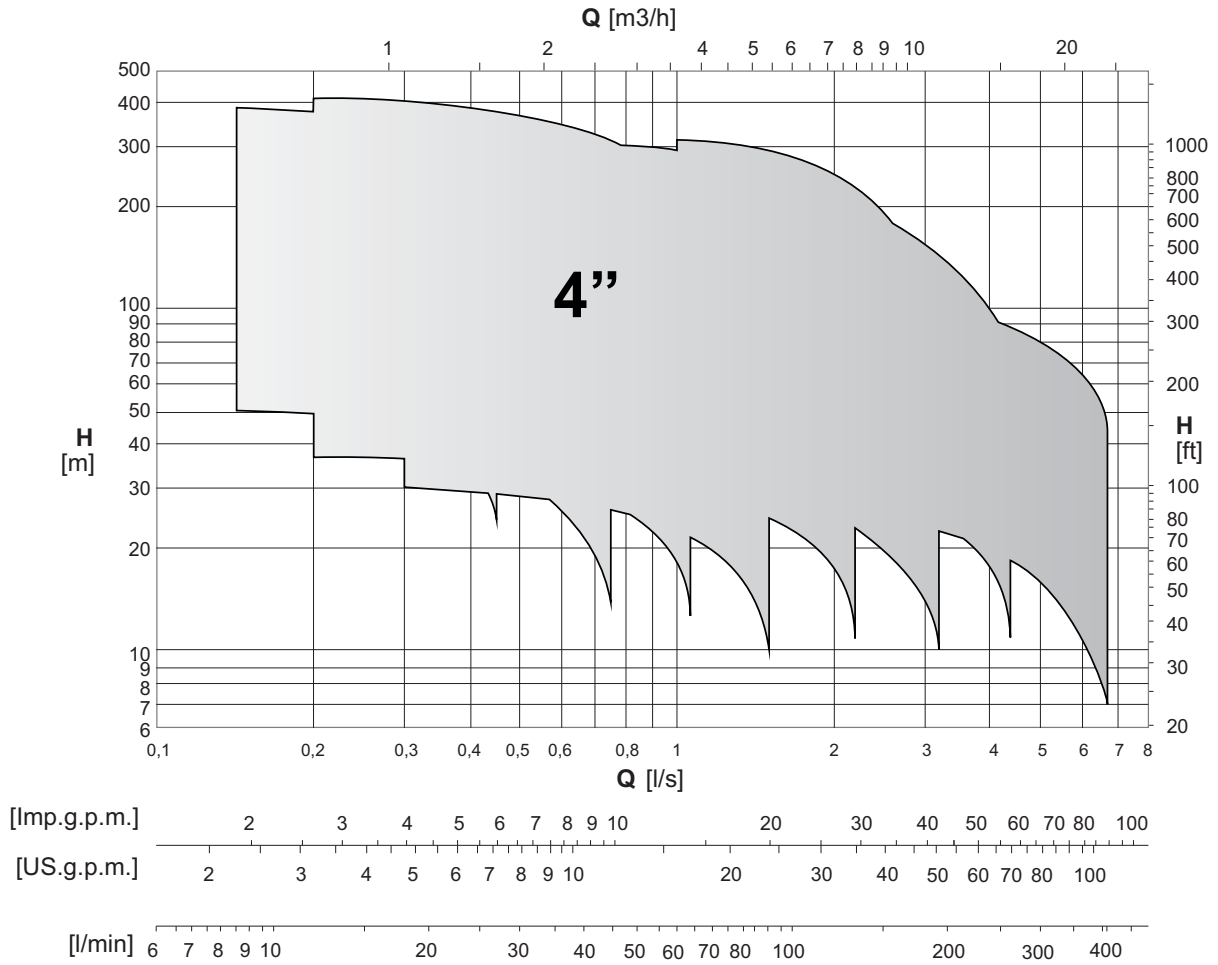

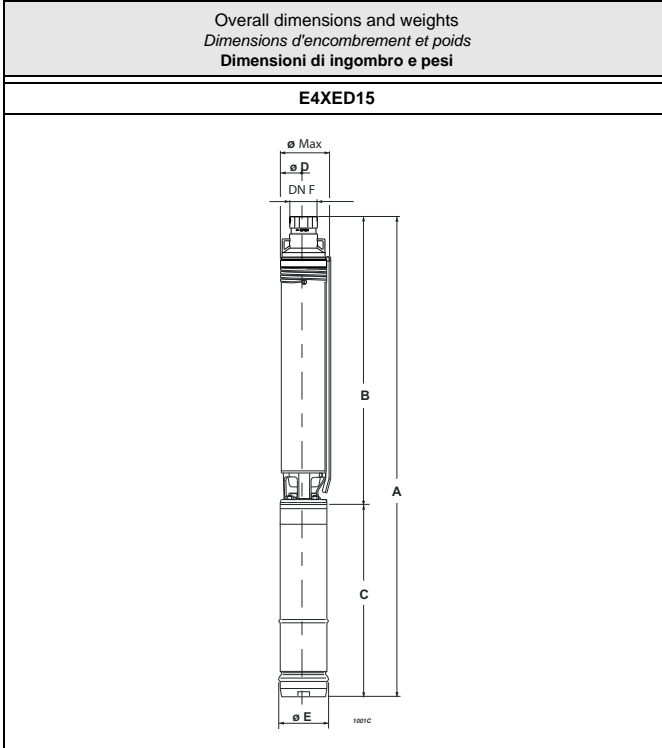

Type Type Tipo	Ø max [mm]	Weight Poids Peso [kg]	A	B	C	D	E	F
			[mm]					
E4XED15/13+MC405	98	10,9	821	476	345	93	96	G1 1/4
E4XED15/19+MC4075	98	12,4	941	596	345	93	96	G1 1/4
E4XED15/26+MC41	98	14,4	1108,5	763,5	345	93	96	G1 1/4
E4XED15/39+MCH415	98	17,7	1393,5	1023,5	370	93	96	G1 1/4
E4XED15/50+MCK42	98	21,1	1629,5	1243,5	386	93	96	G1 1/4

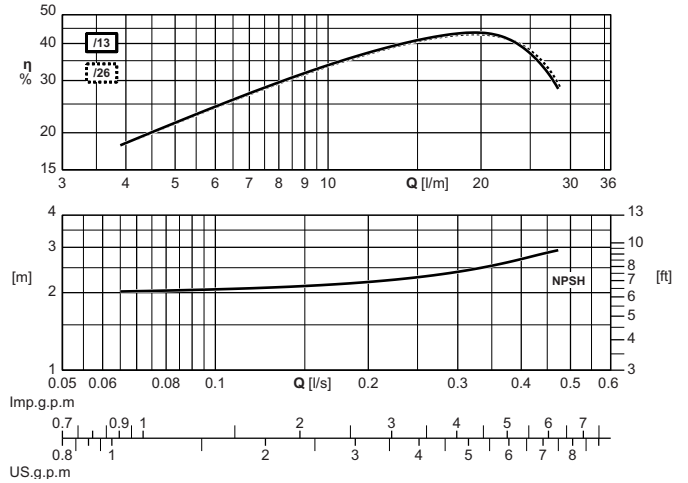
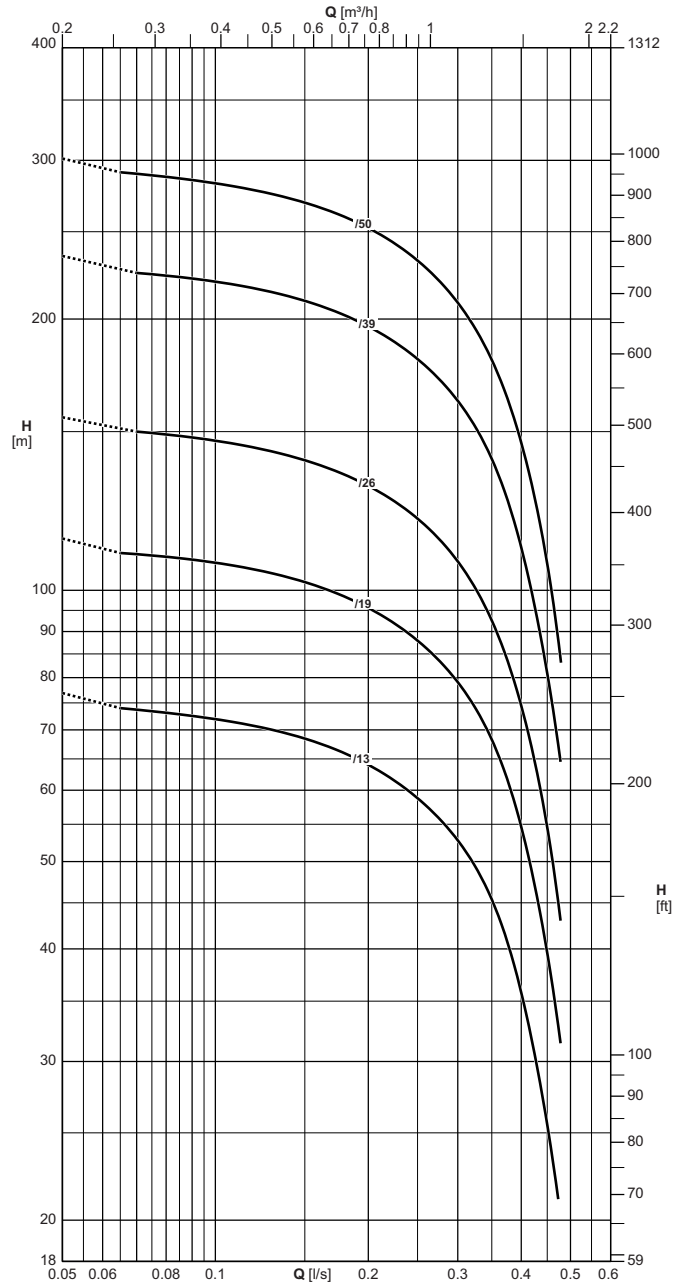

The hydraulic performance characteristics are guaranteed as conforming to standard UNI/ISO 9906 Grade 3B. Available with NPT thread.

Les caractéristiques hydrauliques de fonctionnement sont garanties conformes à la norme UNI/ISO 9906 Niveau 3B. Disponible avec filetage NPT.

Le caratteristiche di funzionamento vengono garantite secondo la norma: UNI/ISO 9906 Grado 3B. Disponibile con filettatura NPT.



Operating data
 Caracteristiques de fonctionnement
 Caratteristiche di funzionamento

Electric pump type Electropompe type Elettropompa tipo	Motor power Puis. moteur Potenza motore		Horizontal installation Installation horizontale Installazione orizzontale	Check valve Ø Clapet de retenue Ø Valvola di ritegno Ø	Capacity Debit Portata					
					[l/s]	0	0,1	0,2	0,3	0,4
	[l/min]	0			6	12	18	24		
	[m³/h]	0			0,4	0,7	1,1	1,4		
[kW]	[HP]	Head Hauteur Prevalenza								
E4XED15/13+MC405	0,37	0,5	m	11/4" Gas	[m]	77	74	68	58	42,5
E4XED15/19+MC4075	0,55	0,8	m	11/4" Gas	[m]	114	110	102	86	63
E4XED15/26+MC41	0,75	1	m	11/4" Gas	[m]	155	150	138	117	85
E4XED15/39+MCH415	1,1	1,5	m	11/4" Gas	[m]	235	225	208	176	129
E4XED15/50+MCK42	1,5	2	m	11/4" Gas	[m]	301	291	269	227	167
NPSH					[m]	-	2	2,1	2,3	2,6
M.E.I. ≥ 0.40										

n Without conical valve

o On request

m Please contact our sales organisation

For motor performances specification see page "motor features"

n Sans soupape du clapet.

o Sur demande

m Contacter notre service commercial.

Pour caractéristiques techniques moteurs voir page "Caractéristiques des moteurs"

n Senza clapet valvola di ritegno

o Su richiesta

m Interpellare la sede o la rete di vendita

Per caratteristiche motori vedere pagina caratteristiche motori

Temperature monitoring device for submersed electric motors 4" ÷ 6": see page "Accessories"

Appareillage de contrôle de la température des moteurs électriques immergés 4" ÷ 6": voir page "Accessories"

Apparecchiatura di controllo temperatura motori elettrici sommersi 4" ÷ 6": vedere pagina accessori

Operating data
Caracteristiques de fonctionnement
Caratteristiche di funzionamento

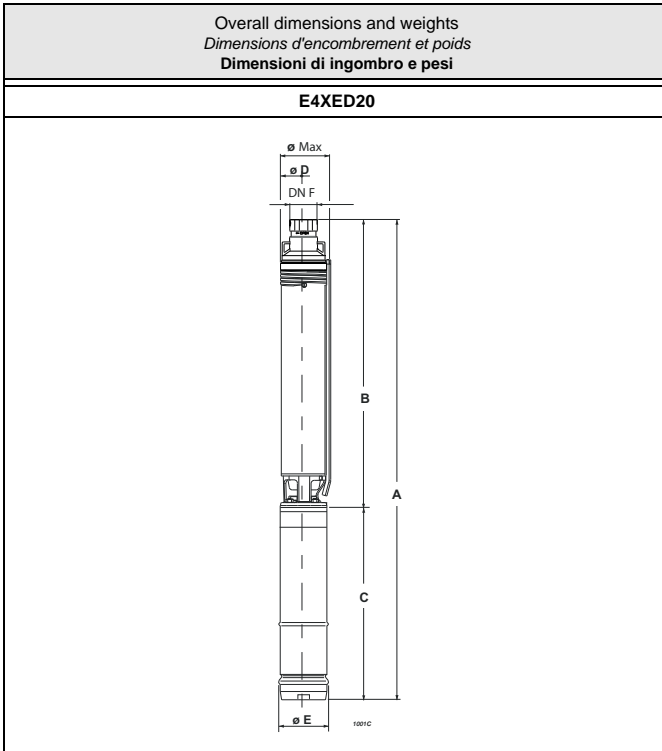

Type Type Tipo	Ø max [mm]	Weight Poids Peso [kg]	A	B	C	D	E	F
			[mm]					
E4XED20/9+MC405	98	10,2	741	396	345	93	96	G1 1/4
E4XED20/14+MC4075	98	11,6	841	496	345	93	96	G1 1/4
E4XED20/19+MC41	98	13,1	941	596	345	93	96	G1 1/4
E4XED20/29+MCH415	98	16,1	1193,5	823,5	370	93	96	G1 1/4
E4XED20/38+MCH42	98	19,2	1389,5	1003,5	386	93	96	G1 1/4
E4XED20/50+MCK43	98	22,9	1693,5	1243,5	450	93	96	G1 1/4
E4XED20/57+MCK43	98	24,4	1853,5	1403,5	450	93	96	G1 1/4
E4XED20/66+MCR44	98	29	2033,5	1583,5	450	93	96	G1 1/4

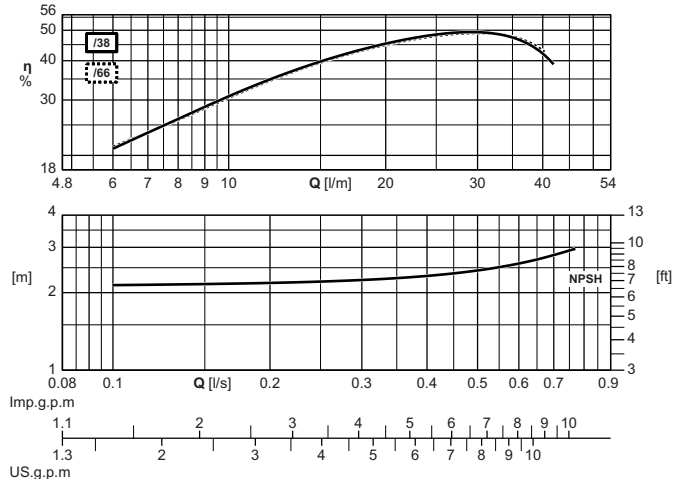
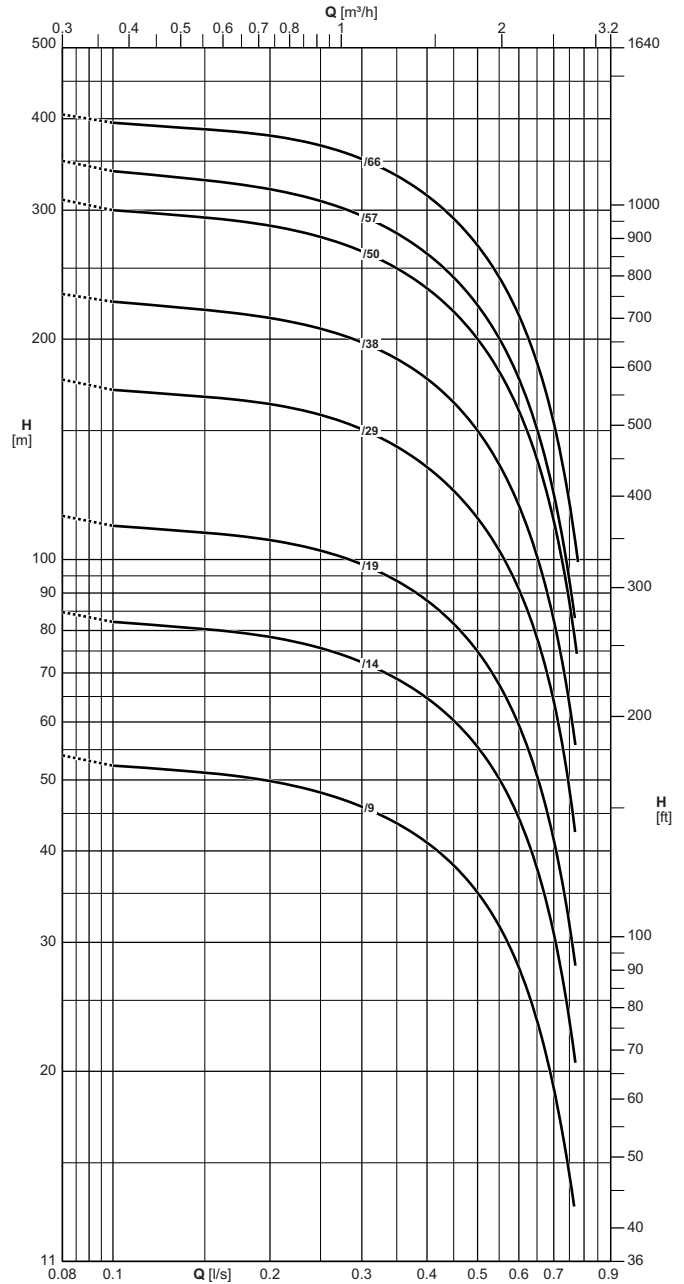

The hydraulic performance characteristics are guaranteed as conforming to standard UNI/ISO 9906 Grade 3B. Available with NPT thread.

Les caractéristiques hydrauliques de fonctionnement sont garanties conformes à la norme UNI/ISO 9906 Niveau 3B. Disponible avec filetage NPT.

Le caratteristiche di funzionamento vengono garantite secondo la norma: UNI/ISO 9906 Grado 3B. Disponibile con filettatura NPT.



Operating data
 Caracteristiques de fonctionnement
 Caratteristiche di funzionamento

Electric pump type Electropompe type Elettropompa tipo	Motor power Puis. moteur Potenza motore		Horizontal installation Installation horizontale Installazione orizzontale	Check valve Ø Clapet de retenue Ø Valvola di ritegno Ø	Capacity Debit Portata							
	[kW]	[HP]			[l/s]	0	0,1	0,2	0,3	0,4	0,5	0,6
					[l/min]	0	6	12	18	24	30	36
					[m³/h]	0	0,4	0,7	1,1	1,4	1,8	2,2
					Head Hauteur Prevalenza							
					[m]	54	52	51	47	42	38	31
E4XED20/9+MC405	0,37	0,5	m	11/4" Gas	[m]	54	52	51	47	42	38	31
E4XED20/14+MC4075	0,55	0,8	m	11/4" Gas	[m]	85	82	79	74	66	60	49
E4XED20/19+MC41	0,75	1	m	11/4" Gas	[m]	115	111	108	101	90	81	66
E4XED20/29+MCH415	1,1	1,5	m	11/4" Gas	[m]	176	170	165	154	137	124	101
E4XED20/38+MCH42	1,5	2	m	11/4" Gas	[m]	230	225	217	202	181	163	132
E4XED20/50+MCK43	2,2	3	m	11/4" Gas	[m]	310	300	290	269	239	216	176
E4XED20/57+MCK43	2,2	3	m	11/4" Gas	[m]	350	339	326	302	268	242	197
E4XED20/66+MCR44	3	4	m	11/4" Gas	[m]	405	395	384	359	334	289	235
NPSH					[m]	-	2,1	2,2	2,2	2,3	2,4	2,5

M.E.I. ≥ 0,40

n Without conical valve

o On request

m Please contact our sales organisation

For motor performances specification see page "motor features"

n Sans soupape du clapet.

o Sur demande

m Contacter notre service commercial.

Pour caractéristiques techniques moteurs voir page "Caractéristiques des moteurs"

n Senza clapet valvola di ritegno

o Su richiesta

m Interpellare la sede o la rete di vendita

Per caratteristiche motori vedere pagina caratteristiche motori

Temperature monitoring device for submersed electric motors 4" ÷ 6": Appareillage de contrôle de la température des moteurs électriques immergés 4" ÷ 6": voir page "Accessories"

Apparecchiatura di controllo temperatura motori elettrici sommersi 4" ÷ 6": vedere pagina accessori

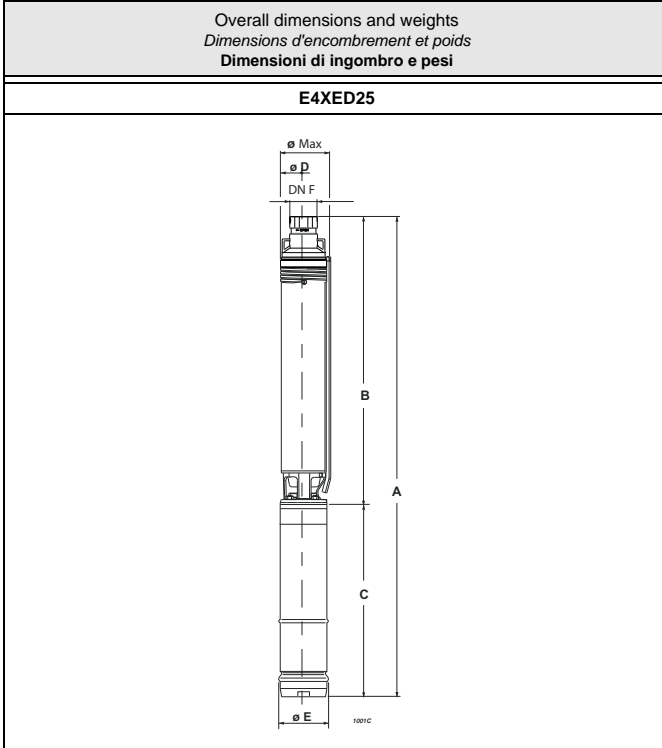

Type Type Tipo	Ø max [mm]	Weight Poids Peso [kg]	A	B	C	D	E	F
			[mm]					
E4XED25/6+MC405	98	10,2	681	336	345	93	96	G1 1/4
E4XED25/9+MC4075	98	10,8	741	396	345	93	96	G1 1/4
E4XED25/12+MC41	98	11,9	801	456	345	93	96	G1 1/4
E4XED25/18+MCH415	98	14	946	576	370	93	96	G1 1/4
E4XED25/25+MCH42	98	16,7	1129,5	743,5	386	93	96	G1 1/4
E4XED25/31+MCK43	98	19,7	1313,5	863,5	450	93	96	G1 1/4
E4XED25/37+MCK43	98	20,4	1433,5	983,5	450	93	96	G1 1/4
E4XED25/43+MCR44	98	24,5	1553,5	1103,5	450	93	96	G1 1/4
E4XED25/50+MCR44	98	25,6	1693,5	1243,5	450	93	96	G1 1/4
E4XED25/57+MCR455	98	27,2	1908,5	1403,5	505	93	96	G1 1/4
E4XED25/66+MCR455	98	28,7	2088,5	1583,5	505	93	96	G1 1/4

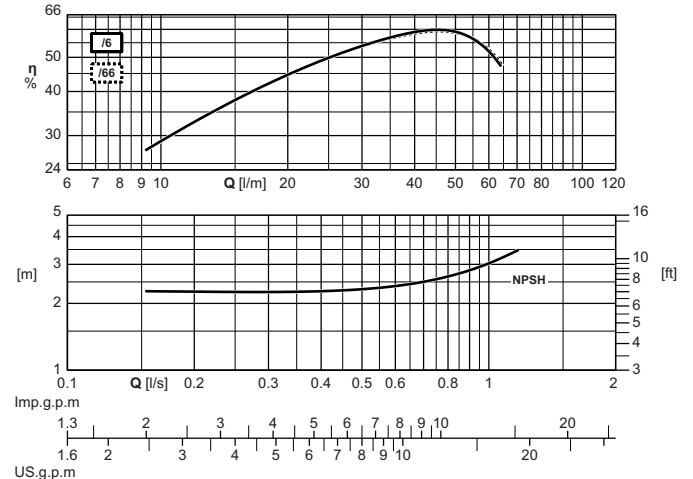
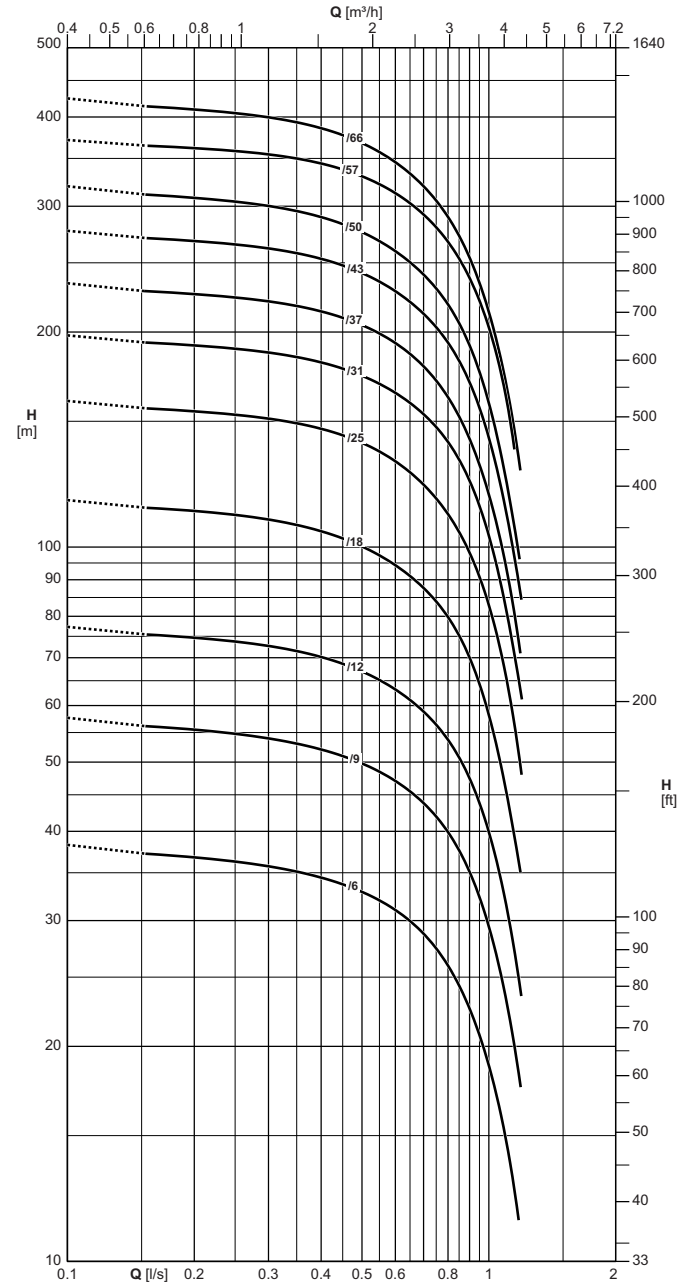

The hydraulic performance characteristics are guaranteed as conforming to standard UNI/ISO 9906 Grade 3B. Available with NPT thread.

Les caractéristiques hydrauliques de fonctionnement sont garanties conformes à la norme UNI/ISO 9906 Niveau 3B. Disponible avec filetage NPT.

Le caratteristiche di funzionamento vengono garantite secondo la norma: UNI/ISO 9906 Grado 3B. Disponibile con filettatura NPT.



Operating data
Caracteristiques de fonctionnement
Caratteristiche di funzionamento

Electric pump type Electropompe type Elettropompa tipo	Motor power Puis. moteur Potenza motore		Horizontal installation Installation horizontale Installazione orizzontale	Check valve Ø Clapet de retenue Ø Valvola di ritegno Ø	Capacity Debit Portata											
	[kW]	[HP]			[l/s]	0	0,2	0,3	0,4	0,5	0,6	0,7	0,8	0,9	1	1,2
					[l/min]	0	12	18	24	30	36	42	48	54	60	72
					[m³/h]	0	0,7	1,1	1,4	1,8	2,2	2,5	2,9	3,2	3,6	4,3
Head Hauteur Prevalenza																
E4XED25/6+MC405	0,37	0,5	m	11/4" Gas	[m]	38,5	37	36	35	33,5	31,5	29	26	24	20,5	11,5
E4XED25/9+MC4075	0,55	0,8	m	11/4" Gas	[m]	58	56	55	53	50	47,5	44	42	37	31	17,5
E4XED25/12+MC41	0,75	1	m	11/4" Gas	[m]	77	75	73	71	67	63	59	56	50	42	23,5
E4XED25/18+MCH415	1,1	1,5	m	11/4" Gas	[m]	116	113	110	106	101	95	88	84	74	62	35
E4XED25/25+MCH42	1,5	2	m	11/4" Gas	[m]	160	156	153	148	141	132	122	116	103	87	48
E4XED25/31+MCK43	2,2	3	m	11/4" Gas	[m]	198	193	189	183	175	165	153	146	129	108	61
E4XED25/37+MCK43	2,2	3	m	11/4" Gas	[m]	234	228	223	216	206	194	179	171	150	126	71
E4XED25/43+MCR44	3	4	m	11/4" Gas	[m]	277	271	264	256	244	229	212	202	178	149	84
E4XED25/50+MCR44	3	4	m	11/4" Gas	[m]	320	311	304	293	279	262	242	218	204	170	96
E4XED25/57+MCR455	4	5,5	m	11/4" Gas	[m]	371	365	358	348	335	318	297	272	242	206	137
E4XED25/66+MCR455	4	5,5	m	11/4" Gas	[m]	425	414	404	390	372	348	320	305	269	226	128
NPSH					[m]	-	2,3	2,3	2,3	2,3	2,4	2,5	2,6	2,7	2,9	3,4
M.E.I. ≥ 0.40																

n Without conical valve

o On request

m Please contact our sales organisation

For motor performances specification see page "motor features"

n Sans soupape du clapet.

o Sur demande

m Contacter notre service commercial.

Pour caractéristiques techniques moteurs voir page "Caractéristiques des moteurs"

n Senza clapet valvola di ritegno

o Su richiesta

m Interpellare la sede o la rete di vendita

Per caratteristiche motori vedere pagina caratteristiche motori

Temperature monitoring device for submersed electric motors 4" ÷ 6": see page "Accessories"

Appareillage de contrôle de la température des moteurs électriques immergés 4" ÷ 6": voir page "Accessories"

Apparecchiatura di controllo temperatura motori elettrici sommersi 4" ÷ 6": vedere pagina accessori

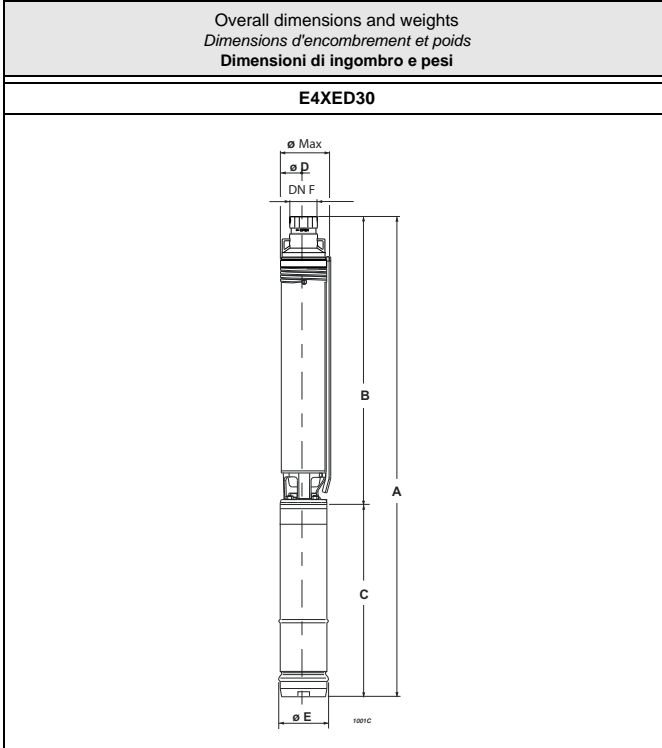

Type Type Tipo	Ø max [mm]	Weight Poids Peso [kg]	A	B	C	D	E	F
			[mm]					
E4XED30/5+MC405	98	9,7	686	341	345	93	96	G1 1/4
E4XED30/8+MC4075	98	10,9	761	416	345	93	96	G1 1/4
E4XED30/11+MC41	98	11,9	836	491	345	93	96	G1 1/4
E4XED30/16+MCH415	98	14	986	616	370	93	96	G1 1/4
E4XED30/21+MCH42	98	16,7	1154,5	768,5	386	93	96	G1 1/4
E4XED30/32+MCK43	98	20,5	1493,5	1043,5	450	93	96	G1 1/4
E4XED30/43+MCR44	98	25,9	1796	1346	450	93	96	G1 1/4
E4XED30/51+MCR455	98	27,6	2051	1546	505	93	96	G1 1/4
E4XED30/57+MCR455	98	28,7	2201	1696	505	93	96	G1 1/4

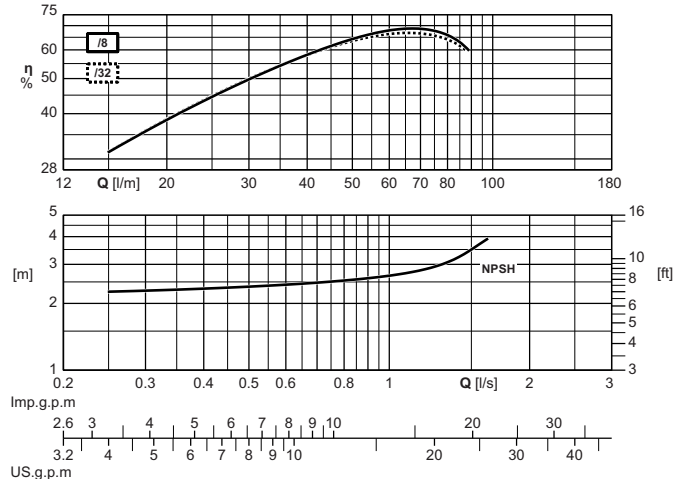
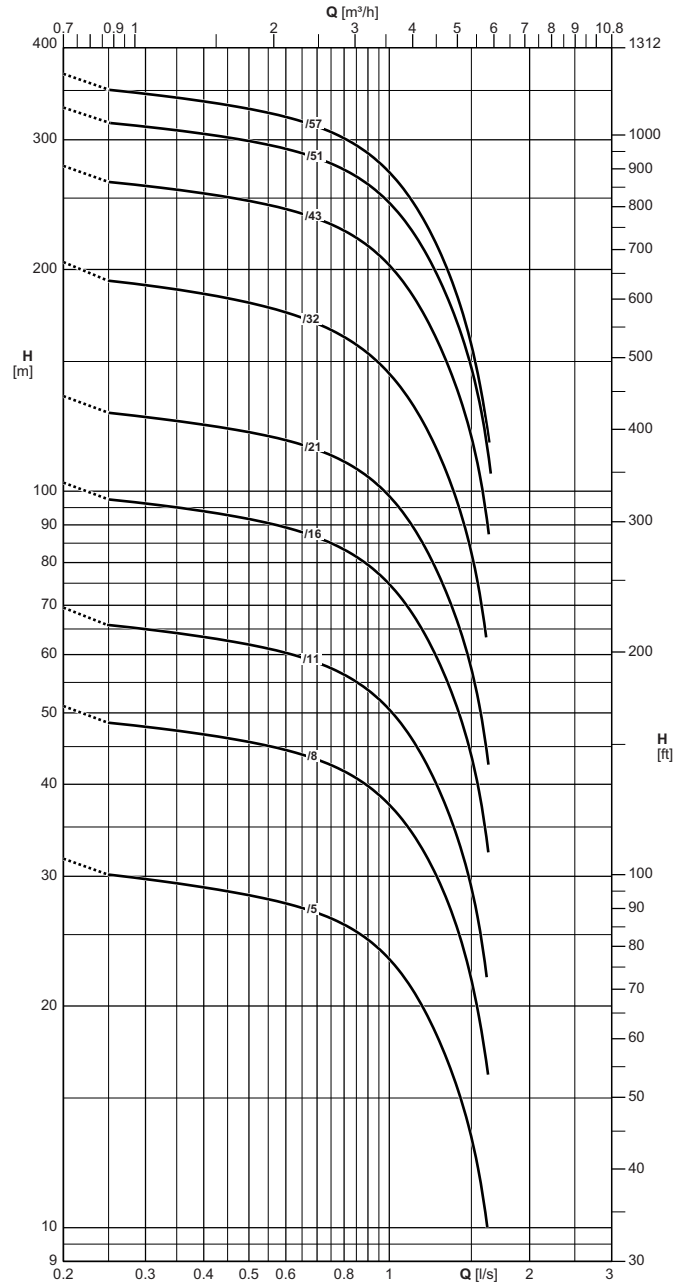

The hydraulic performance characteristics are guaranteed as conforming to standard UNI/ISO 9906 Grade 3B. Available with NPT thread.

Les caractéristiques hydrauliques de fonctionnement sont garanties conformes à la norme UNI/ISO 9906 Niveau 3B. Disponible avec filetage NPT.

Le caratteristiche di funzionamento vengono garantite secondo la norma: UNI/ISO 9906 Grado 3B. Disponibile con filettatura NPT.



Operating data
Caracteristiques de fonctionnement
Caratteristiche di funzionamento

Electric pump type Electropompe type Elettropompa tipo	Motor power Puis. moteur Potenza motore		Horizontal installation Installation horizontale Installazione orizzontale	Check valve Ø Clapet de retenue Ø Valvola di ritegno Ø	Capacity Debit Portata												
	[kW]	[HP]			[l/s]	0	0,3	0,4	0,5	0,6	0,7	0,8	0,9	1	1,2	1,4	1,6
					[l/min]	0	18	24	30	36	42	48	54	60	72	84	96
					[m³/h]	0	1,1	1,4	1,8	2,2	2,5	2,9	3,2	3,6	4,3	5	5,8
		Head Hauteur Prevalenza															
		[m]	31,5	29,5	29	28,5	27,5	27	26,5	24,5	23,5	20	15,5	12			
E4XED30/5+MC405	0,37	0,5	m	11/4" Gas	[m]	31,5	29,5	29	28,5	27,5	27	26,5	24,5	23,5	20	15,5	12
E4XED30/8+MC4075	0,55	0,8	m	11/4" Gas	[m]	51	47,5	47	46	44,5	43,5	42,5	39,5	38	32	25	19,5
E4XED30/11+MC41	0,75	1	m	11/4" Gas	[m]	69	64	63	62	60	59	57	54	52	43,5	34	22
E4XED30/16+MCH415	1,1	1,5	m	11/4" Gas	[m]	103	97	94	92	89	87	85	79	76	64	50	39
E4XED30/21+MCH42	1,5	2	m	11/4" Gas	[m]	134	128	123	121	117	114	111	104	100	84	65	51
E4XED30/32+MCK43	2,2	3	m	11/4" Gas	[m]	205	189	186	182	174	170	165	154	148	124	97	63
E4XED30/43+MCR44	3	4	m	11/4" Gas	[m]	276	263	254	250	240	235	229	214	205	172	134	105
E4XED30/51+MCR455	4	5,5	m	11/4" Gas	[m]	332	316	306	301	290	284	277	259	248	208	178	128
E4XED30/57+MCR455	4	5,5	m	11/4" Gas	[m]	369	351	338	333	321	314	306	286	274	230	179	139
NPSH					[m]	-	2,3	2,3	2,4	2,4	2,5	2,5	2,6	2,6	2,8	3,1	3,7
M.E.I. ≥ 0,40																	

n Without conical valve

o On request

m Please contact our sales organisation

For motor performances specification see page "motor features"

n Sans soupape du clapet.

o Sur demande

m Contacter notre service commercial.

Pour caractéristiques techniques moteurs voir page "Caractéristiques des moteurs"

n Senza clapet valvola di ritegno

o Su richiesta

m Interpellare la sede o la rete di vendita

Per caratteristiche motori vedere pagina caratteristiche motori

Temperature monitoring device for submersed electric motors 4" ÷ 6": see page "Accessories"

Appareillage de contrôle de la température des moteurs électriques immergés 4" ÷ 6": voir page "Accessories"

Apparecchiatura di controllo temperatura motori elettrici sommersi 4" ÷ 6": vedere pagina accessori

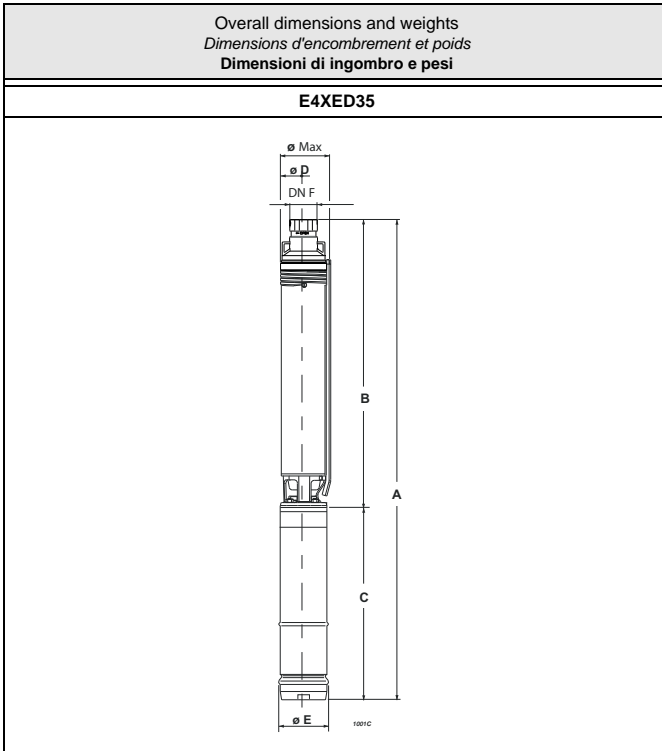

Type Type Tipo	Ø max [mm]	Weight Poids Peso [kg]	A	B	C	D	E	F
			[mm]					
E4XED35/5+MC4075	98	10,8	711	366	345	93	96	G1 1/4
E4XED35/7+MC41	98	12,6	771	426	345	93	96	G1 1/4
E4XED35/10+MCH415	98	13,1	886	516	370	93	96	G1 1/4
E4XED35/14+MCH42	98	15,5	1022	636	386	93	96	G1 1/4
E4XED35/20+MCH43	98	18,8	1293,5	843,5	450	93	96	G1 1/4
E4XED35/27+MCK44	98	23,9	1503,5	1053,5	450	93	96	G1 1/4
E4XED35/36+MCR455	98	25,7	1856	1351	505	93	96	G1 1/4
E4XED35/44+MCR475	98	37	2291	1591	700	93	96	G1 1/4
E4XED35/50+MCR475	98	38,4	2498,5	1798,5	700	93	96	G1 1/4

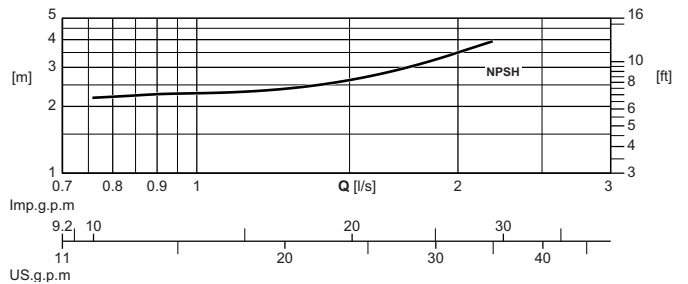
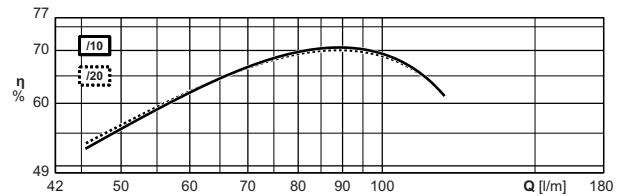
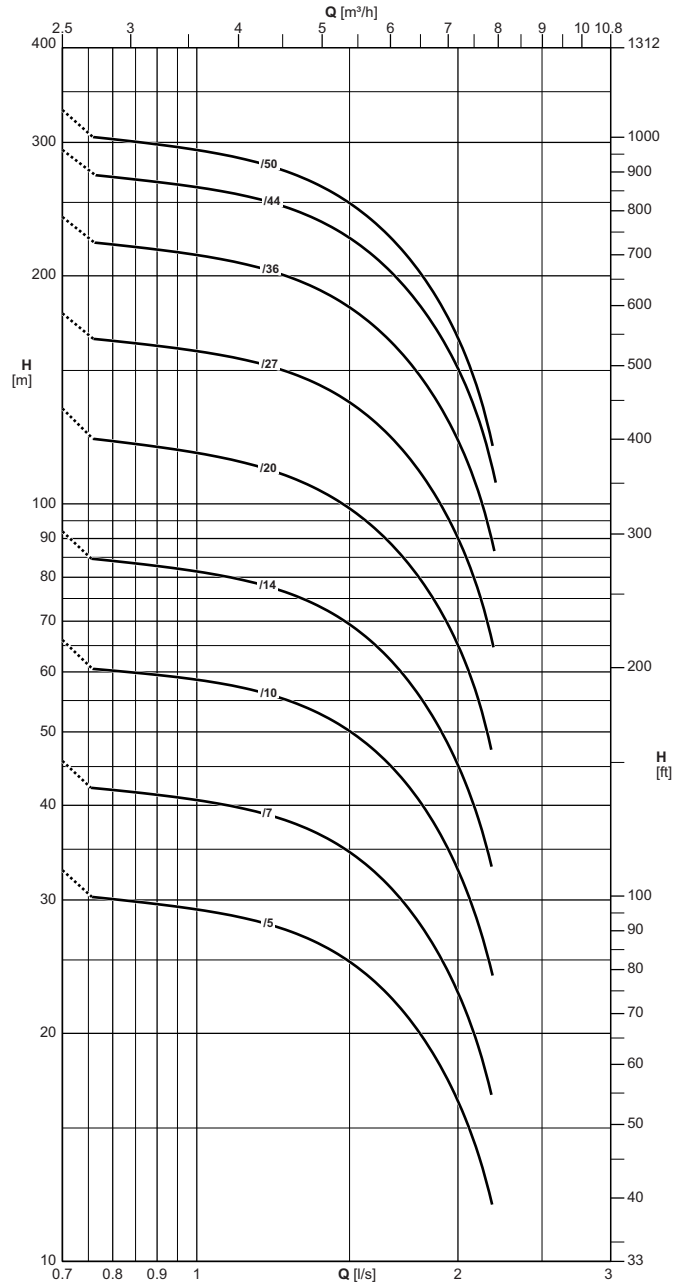

The hydraulic performance characteristics are guaranteed as conforming to standard UNI/ISO 9906 Grade 3B. Available with NPT thread.

Les caractéristiques hydrauliques de fonctionnement sont garanties conformes à la norme UNI/ISO 9906 Niveau 3B. Disponible avec filetage NPT.

Le caratteristiche di funzionamento vengono garantite secondo la norma: UNI/ISO 9906 Grado 3B. Disponibile con filettatura NPT.



Operating data
Caracteristiques de fonctionnement
Caratteristiche di funzionamento

Electric pump type Electropompe type Elettropompa tipo	Motor power Puis. moteur Potenza motore		Horizontal installation Installation horizontale Installazione orizzontale	Check valve Ø Clapet de retenue Ø Valvola di ritegno Ø	Capacity Debit Portata										
					[l/s]	0	0,8	0,9	1	1,2	1,4	1,6	1,8	2	2,2
	[l/min]	0			48	54	60	72	84	96	108	120	132		
	[m³/h]	0			2,9	3,2	3,6	4,3	5	5,8	6,5	7,2	7,9		
[kW]	[HP]	Head Hauteur Prevalenza													
E4XED35/5+MC4075	0,55	0,8	m	11/4" Gas	[m]	33	30,5	29,5	29	28	26,5	23,5	20	17	12
E4XED35/7+MC41	0,75	1	m	11/4" Gas	[m]	46	42	41,5	41	39	37	33	28	24	16,5
E4XED35/10+MCH415	1,1	1,5	m	11/4" Gas	[m]	66	61	59	59	56	53	47,5	40	34,5	24
E4XED35/14+MCH42	1,5	2	m	11/4" Gas	[m]	92	84	83	82	78	74	66	55	47,5	33
E4XED35/20+MCH43	2,2	3	m	11/4" Gas	[m]	133	122	119	117	111	105	94	79	68	47,5
E4XED35/27+MCK44	3	4	m	11/4" Gas	[m]	178	165	161	159	152	144	129	109	93	65
E4XED35/36+MCR455	4	5,5	m	11/4" Gas	[m]	239	221	216	213	203	193	172	145	125	86
E4XED35/44+MCR475	5,5	7,5	m	11/4" Gas	[m]	293	272	265	262	250	237	212	191	154	107
E4XED35/50+MCR475	5,5	7,5	m	11/4" Gas	[m]	331	305	298	294	279	266	237	201	172	119
NPSH					[m]	-	2,2	2,3	2,3	2,4	2,5	2,7	3	3,4	3,9

M.E.I. ≥ 0,40

n Without conical valve

o On request

m Please contact our sales organisation

For motor performances specification see page "motor features"

n Sans soupape du clapet.

o Sur demande

m Contacter notre service commercial.

Pour caractéristiques techniques moteurs voir page "Caractéristiques des moteurs"

n Senza clapet valvola di ritegno

o Su richiesta

m Interpellare la sede o la rete di vendita

Per caratteristiche motori vedere pagina caratteristiche motori

Temperature monitoring device for submersed electric motors 4" ÷ 6": see page "Accessories"

Appareillage de contrôle de la température des moteurs électriques immergés 4" ÷ 6": voir page "Accessories"

Apparecchiatura di controllo temperatura motori elettrici sommersi 4" ÷ 6": vedere pagina accessori

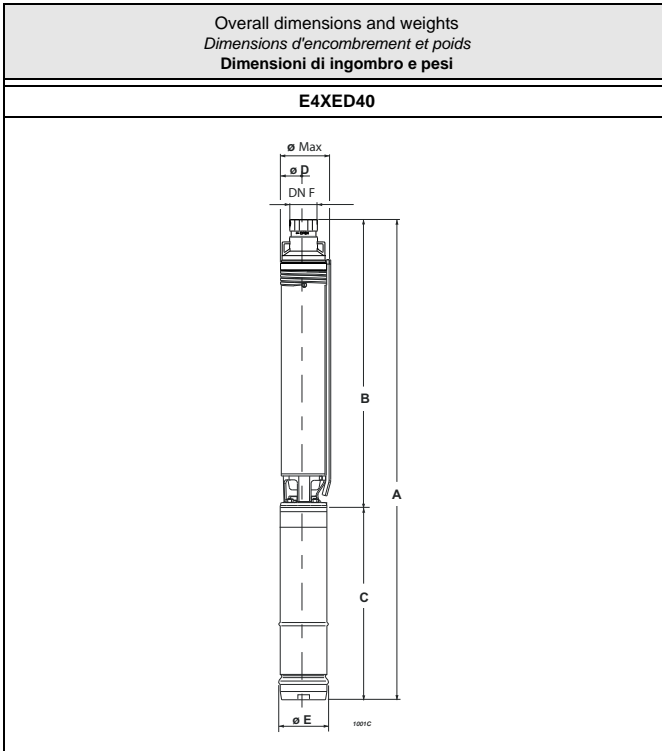

Type Type Tipo	Ø max [mm]	Weight Poids Peso [kg]	A	B	C	D	E	F
			[mm]					
E4XED40/6+MC41	98	11,4	788	443	345	93	96	G2
E4XED40/9+MCH415	98	13,6	925,5	555,5	370	93	96	G2
E4XED40/12+MCH42	98	15,8	1054	668	386	93	96	G2
E4XED40/17+MCH43	98	19	1333	883	450	93	96	G2
E4XED40/23+MCK44	98	23,9	1558	1108	450	93	96	G2
E4XED40/30+MCR455	98	26	1903	1398	505	93	96	G2
E4XED40/36+MCR475	98	37,2	2323	1623	700	93	96	G2
E4XED40/42+MCR475	98	39	2575,5	1875,5	700	93	96	G2
E4XED40/48+MCR410	98	44,8	2900,5	2100,5	800	93	96	G2
E4XED40/56+MCR410	98	47	3200,5	2400,5	800	93	96	G2

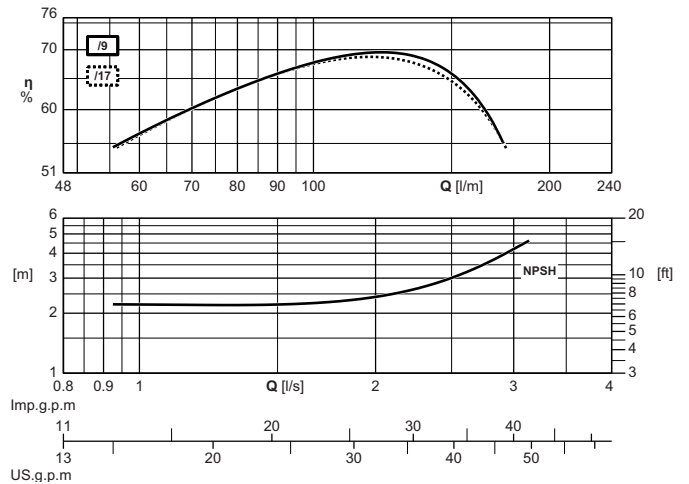
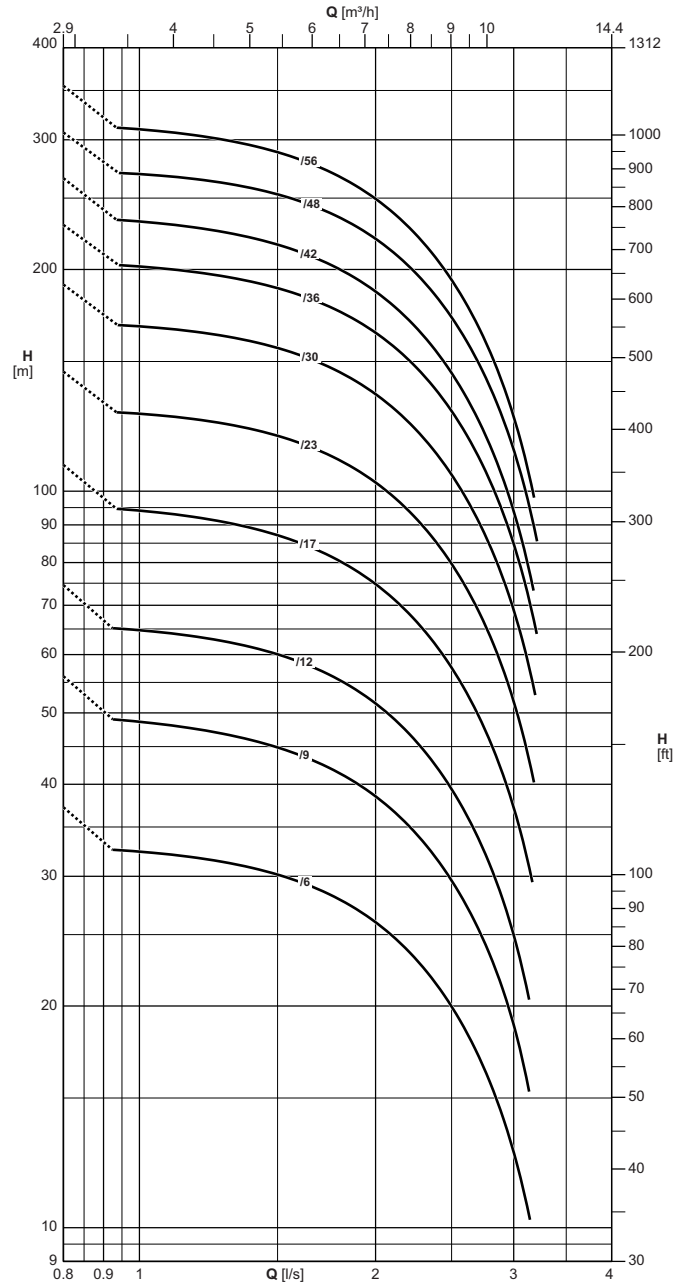

The hydraulic performance characteristics are guaranteed as conforming to standard UNI/ISO 9906 Grade 3B. Available with NPT thread.

Les caractéristiques hydrauliques de fonctionnement sont garanties conformes à la norme UNI/ISO 9906 Niveau 3B. Disponible avec filetage NPT.

Le caratteristiche di funzionamento vengono garantite secondo la norma: UNI/ISO 9906 Grado 3B. Disponibile con filettatura NPT.



Operating data
Caracteristiques de fonctionnement
Caratteristiche di funzionamento

Electric pump type Electropompe type Elettropompa tipo	Motor power Puis. moteur Potenza motore		Horizontal installation Installation horizontale Installazione orizzontale	Check valve Ø Clapet de retenue Ø Valvola di ritegno Ø	Capacity Debit Portata												
					[l/s]	0	1	1,2	1,4	1,6	1,8	2	2,2	2,4	2,6	2,8	3
	[l/min]	0			60	72	84	96	108	120	132	144	156	168	180		
	[m³/h]	0			3,6	4,3	5	5,8	6,5	7,2	7,9	8,6	9,4	10,1	10,8		
[kW]	[HP]	Head Hauteur Prevalenza															
E4XED40/6+MC41	0,75	1	m	2" Gas	[m]	37	32,5	32	31	29,5	28	26	23,5	20,5	19	16	12
E4XED40/9+MCH415	1,1	1,5	m	2" Gas	[m]	56	48,5	47,5	46	43,5	41,5	39	35	31	28,5	23,5	18,5
E4XED40/12+MCH42	1,5	2	m	2" Gas	[m]	74	64	64	61	58	55	52	47	41	38	31,5	24,5
E4XED40/17+MCH43	2,2	3	m	2" Gas	[m]	108	94	92	89	84	81	75	67	61	54	45	37,5
E4XED40/23+MCK44	3	4	m	2" Gas	[m]	145	127	125	121	115	111	103	92	87	75	62	51
E4XED40/30+MCR455	4	5,5	m	2" Gas	[m]	191	167	165	159	153	146	135	121	114	98	81	72
E4XED40/36+MCR475	5,5	7,5	m	2" Gas	[m]	230	202	198	191	185	176	163	151	138	119	104	87
E4XED40/42+MCR475	5,5	7,5	m	2" Gas	[m]	266	232	228	220	209	202	187	168	158	136	112	93
E4XED40/48+MCR410	7,5	10	m	2" Gas	[m]	307	269	265	257	248	237	219	203	185	159	139	117
E4XED40/56+MCR410	7,5	10	m	2" Gas	[m]	355	310	304	294	279	270	249	225	211	182	150	125
NPSH					[m]	-	2,2	2,2	2,2	2,2	2,3	2,4	2,6	2,8	3,1	3,6	4,1

M.E.I. ≥ 0.40

n Without conical valve

o On request

m Please contact our sales organisation

For motor performances specification see page "motor features"

n Sans soupape du clapet.

o Sur demande

m Contacter notre service commercial.

Pour caractéristiques techniques moteurs voir page "Caractéristiques des moteurs"

n Senza clapet valvola di ritegno

o Su richiesta

m Interpellare la sede o la rete di vendita

Per caratteristiche motori vedere pagina caratteristiche motori

Temperature monitoring device for submersed electric motors 4" ÷ 6": see page "Accessories"

Appareillage de contrôle de la température des moteurs électriques immergés 4" ÷ 6": voir page "Accessories"

Apparecchiatura di controllo temperatura motori elettrici sommersi 4" ÷ 6": vedere pagina accessori

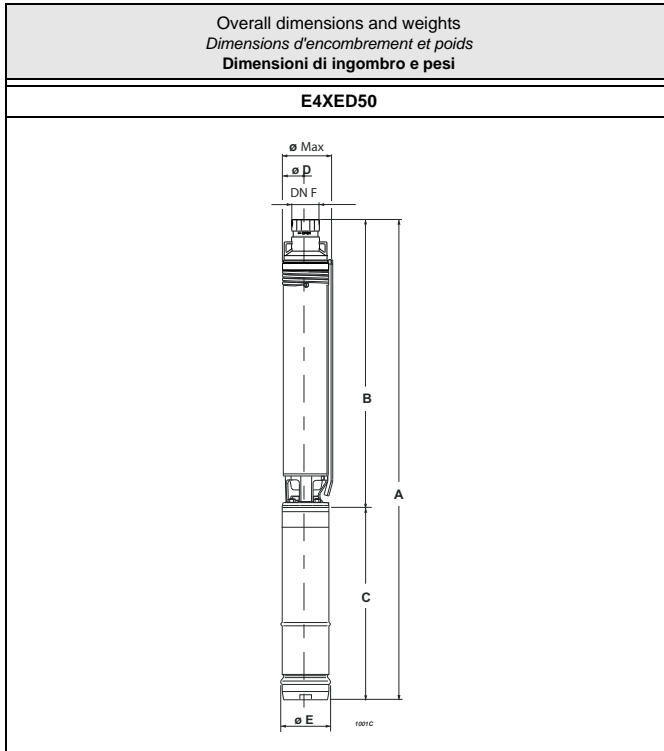

Type Type Tipo	Ø max [mm]	Weight Poids Peso [kg]	A	B	C	D	E	F
			[mm]					
E4XED50/6+MCH415	98	12,7	843	473	370	93	96	G2
E4XED50/8+MCH42	98	15,1	944	558	386	93	96	G2
E4XED50/12+MCH43	98	18,2	1205,5	755,5	450	93	96	G2
E4XED50/16+MCK44	98	22,5	1375,5	925,5	450	93	96	G2
E4XED50/22+MCR455	98	24,4	1685,5	1180,5	505	93	96	G2
E4XED50/30+MCR475	98	36,9	2248	1548	700	93	96	G2
E4XED50/40+MCR410	98	44,3	2800,5	2000,5	800	93	96	G2

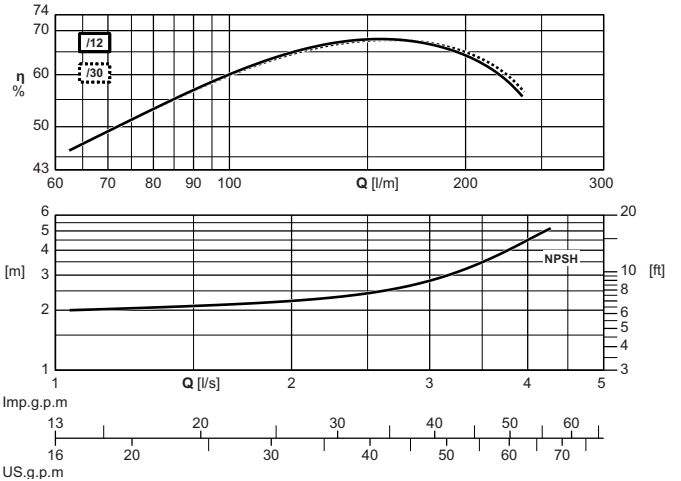
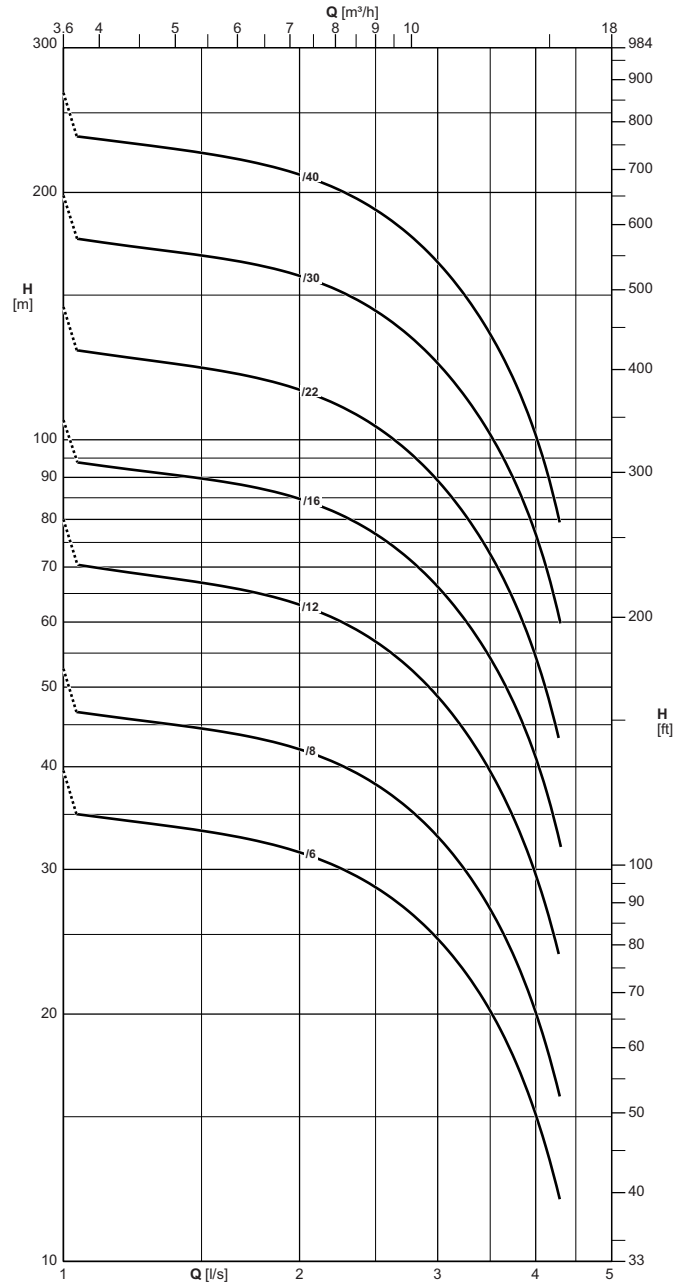

The hydraulic performance characteristics are guaranteed as conforming to standard UNI/ISO 9906 Grade 3B. Available with NPT thread.

Les caractéristiques hydrauliques de fonctionnement sont garanties conformes à la norme UNI/ISO 9906 Niveau 3B. Disponible avec filetage NPT.

Le caratteristiche di funzionamento vengono garantite secondo la norma: UNI/ISO 9906 Grado 3B. Disponibile con filettatura NPT.



Operating data
 Caracteristiques de fonctionnement
 Caratteristiche di funzionamento

Electric pump type Electropompe type Elettropompa tipo	Motor power Puis. moteur Potenza motore		Horizontal installation Installation horizontale Installazione orizzontale	Check valve Ø Clapet de retenue Ø Valvola di ritegno Ø	Capacity Debit Portata														
	[kW]	[HP]			[l/s]	0	1,2	1,4	1,6	1,8	2	2,2	2,4	2,6	2,8	3	3,5	4	
					[l/min]	0	72	84	96	108	120	132	144	156	168	180	210	240	
					[m³/h]	0	4,3	5	5,8	6,5	7,2	7,9	8,6	9,4	10,1	10,8	12,6	14,4	
Head Hauteur Prevalenza																			
E4XED50/6+MCH415	1,1	1,5	m	2" Gas	[m]	39,5	34,5	34	33,5	32,5	31,5	30	29	28	26,5	24,5	20	15,5	
E4XED50/8+MCH42	1,5	2	m	2" Gas	[m]	53	45,5	45	44,5	43	42	40,5	39	37,5	35,5	33	26,5	21	
E4XED50/12+MCH43	2,2	3	m	2" Gas	[m]	80	69	68	66	65	63	60	58	56	52	48,5	39	29	
E4XED50/16+MCK44	3	4	m	2" Gas	[m]	106	92	90	89	87	85	81	78	75	71	66	53	42	
E4XED50/22+MCR455	4	5,5	m	2" Gas	[m]	145	126	124	122	118	115	110	106	102	94	89	72	53	
E4XED50/30+MCR475	5,5	7,5	m	2" Gas	[m]	198	172	169	167	162	158	152	146	140	134	123	100	79	
E4XED50/40+MCR410	7,5	10	m	2" Gas	[m]	264	230	226	222	216	211	202	195	187	178	164	133	99	
NPSH					[m]	-	2	2,1	2,1	2,2	2,2	2,3	2,4	2,5	2,6	2,8	3,5	4,4	
M.E.I. ≥ 0.40																			

n Without conical valve

o On request

m Please contact our sales organisation

For motor performances specification see page "motor features"

Temperature monitoring device for submersed electric motors 4" ÷ 6":
 see page "Accessories"

n Sans soupape du clapet.

o Sur demande

m Contacter notre service commercial.

Pour caractéristiques techniques moteurs voir page "Caractéristiques des moteurs"

Appareillage de contrôle de la température des moteurs électriques immergés 4" ÷ 6": voir page "Accessories"

n Senza clapet valvola di ritegno

o Su richiesta

m Interpellare la sede o la rete di vendita

Per caratteristiche motori vedere pagina caratteristiche motori

Apparecchiatura di controllo temperatura motori elettrici sommersi 4" ÷ 6": vedere pagina accessori

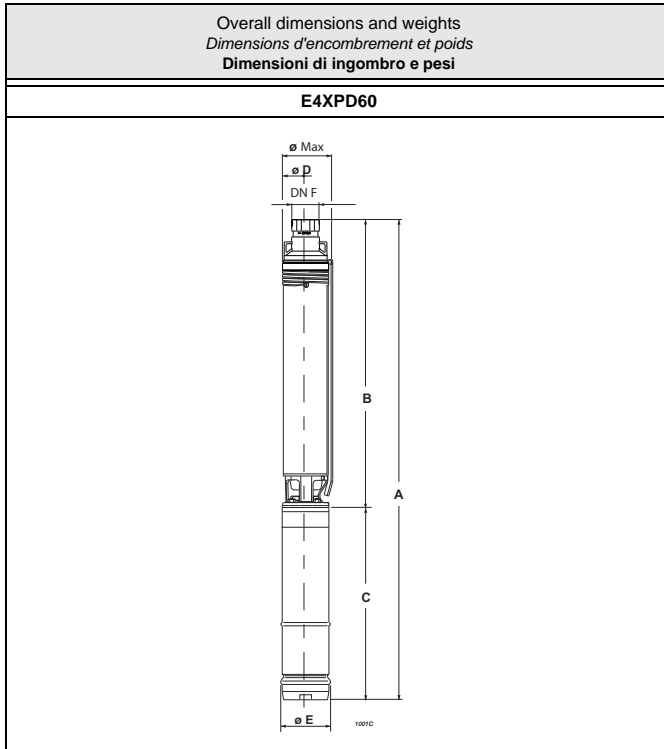

Type Type Tipo	Ø max [mm]	Weight Poids Peso [kg]	A	B	C	D	E	F
			[mm]					
E4XPD60/5+MCH42	100	15	944	558	386	93	96	G2
E4XPD60/7+MCH43	100	17,6	1144	694	450	93	96	G2
E4XPD60/10+MCK44	100	22,3	1375,5	925,5	450	93	96	G2
E4XPD60/13+MCR455	100	23,8	1634,5	1129,5	505	93	96	G2
E4XPD60/18+MCR475	100	35,9	2197	1497	700	93	96	G2
E4XPD60/25+MCR410	100	43,8	2803,5	2003,5	800	93	96	G2

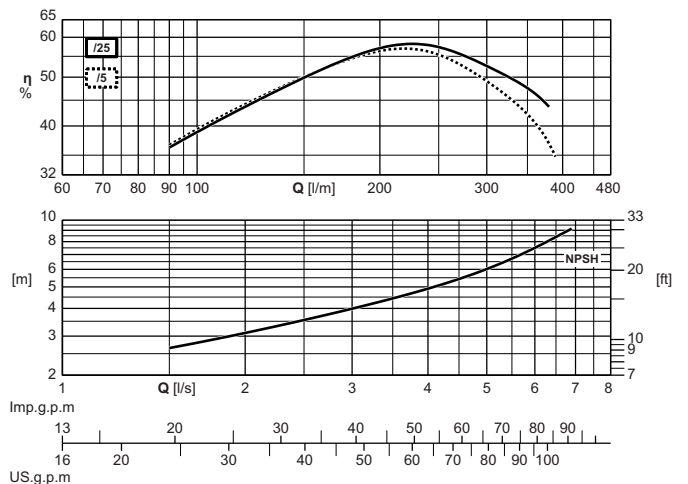
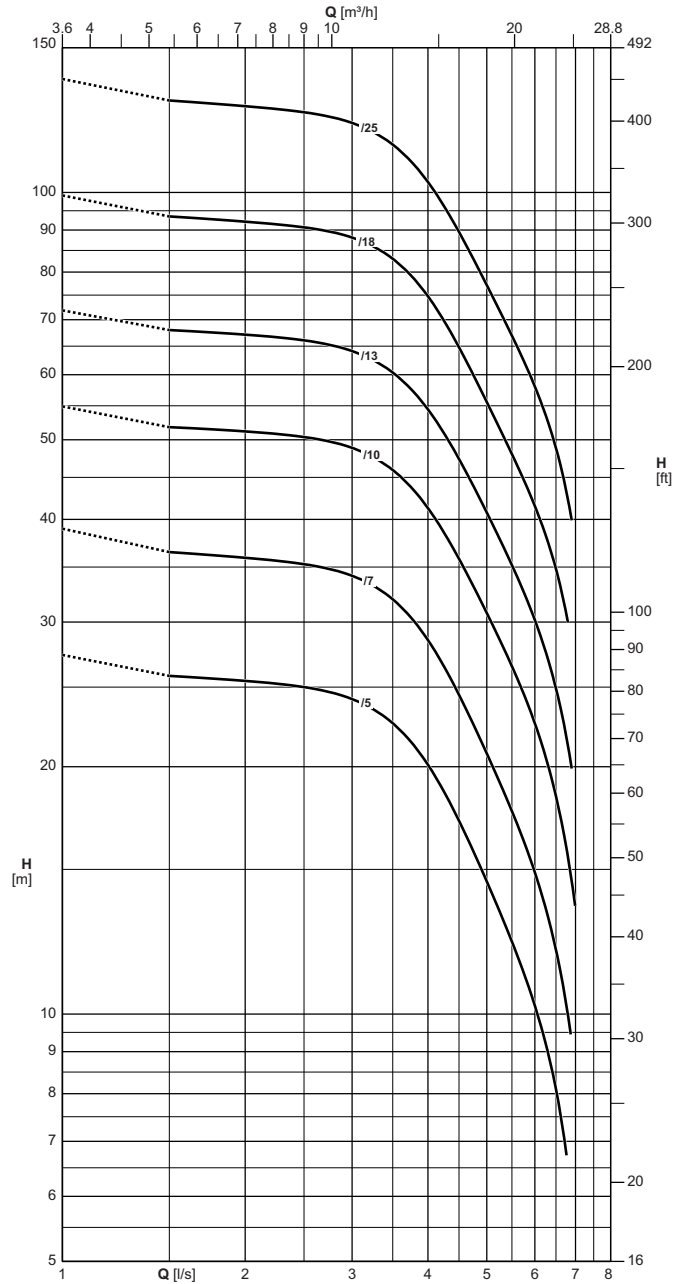

The hydraulic performance characteristics are guaranteed as conforming to standard UNI/ISO 9906 Grade 3B. Available with NPT thread.

Les caractéristiques hydrauliques de fonctionnement sont garanties conformes à la norme UNI/ISO 9906 Niveau 3B. Disponible avec filetage NPT.

Le caratteristiche di funzionamento vengono garantite secondo la norma: UNI/ISO 9906 Grado 3B. Disponibile con filettatura NPT.

Electric pump type Electropompe type Elettropompa tipo	Motor power Puis. moteur Potenza motore		Horizontal installation Installation horizontale Installazione orizzontale	Check valve Ø Clapet de retenue Ø Valvola di ritegno Ø	Capacity Debit Portata																
	[kW]	[HP]			[l/s]	0	1,6	1,8	2	2,2	2,4	2,6	2,8	3	3,5	4	4,5	5	5,5	6	6,5
					[l/min]	0	96	108	120	132	144	156	168	180	210	240	270	300	330	360	390
					[m³/h]	0	5,8	6,5	7,2	7,9	8,6	9,4	10,1	10,8	12,6	14,4	16,2	18	19,8	21,6	23,4
		Head Hauteur Prevalenza																			
		[m]	27,5	25,5	25,5	25,5	25,5	25	25	24,5	24	22,5	20	17	14,5	12,5	10	8,2			
E4XPD60/5+MCH42	1,5	2	m	2" Gas	[m]	27,5	25,5	25,5	25,5	25,5	25	25	24,5	24	22,5	20	17	14,5	12,5	10	8,2
E4XPD60/7+MCH43	2,2	3	m	2" Gas	[m]	39	36,5	36	36	35,5	35,5	35	34,5	34	32	28	24,5	21	18	14,5	12
E4XPD60/10+MCK44	3	4	m	2" Gas	[m]	55	52	51	51	51	51	50	49,5	48,5	46	41	36	31	26	22,5	18,5
E4XPD60/13+MCR455	4	5,5	m	2" Gas	[m]	72	68	67	67	67	66	66	65	64	60	55	47	40,5	35,5	29,5	24,5
E4XPD60/18+MCR475	5,5	7,5	m	2" Gas	[m]	99	93	93	92	91	91	90	89	88	84	74	65	55	48	42	34,5
E4XPD60/25+MCR410	7,5	10	m	2" Gas	[m]	137	129	128	127	127	126	124	123	121	114	104	89	77	67	57	48,5
NPSH					[m]	-	2,7	2,9	3,1	3,3	3,4	3,6	3,8	4	4,4	4,9	5,5	5,9	6,7	7,5	8,4

n Without conical valve

o On request

m Please contact our sales organisation

For motor performances specification see page "motor features"

n Sans soupape du clapet.

o Sur demande

m Contacter notre service commercial.

Pour caractéristiques techniques moteurs voir page "Caractéristiques des moteurs"

n Senza clapet valvola di ritegno

o Su richiesta

m Interpellare la sede o la rete di vendita

Per caratteristiche motori vedere pagina caratteristiche motori

Temperature monitoring device for submersed electric motors 4" ÷ 6": Appareillage de contrôle de la température des moteurs électriques immergés 4" ÷ 6": voir page "Accessories"

Apparecchiatura di controllo temperatura motori elettrici sommersi 4" ÷ 6": vedere pagina accessori

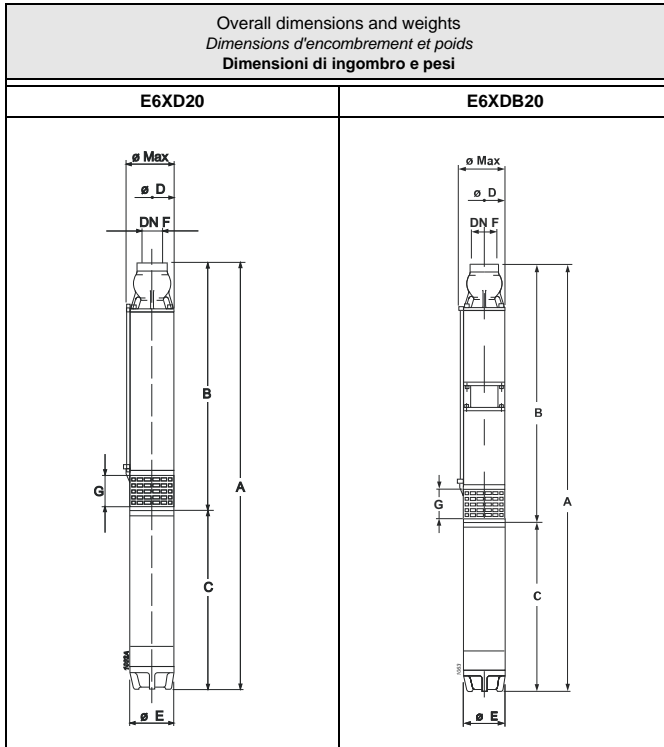

Type Type Tipo	Ø max	Weight Poids Peso	A	B	C	D	E	G	F
	[mm]								
E6XD20/9+MCH415	135	18,7	938	568	370	127	96	-	G2 1/2
E6XD20/12+MCH42	135	22,9	1044	658	386	127	96	-	G2 1/2
E6XD20/18+MCK43	135	28,4	1347	897	450	127	96	-	G2 1/2
E6XD20/24+MCR44	135	33,4	1527	1077	450	127	96	-	G2 1/2
E6XD20/30+MCR455	135	37,7	1762	1257	505	127	96	-	G2 1/2
E6XD20/30+MAC65A	145	58,6	1862	1292	570	141	143	100	G2 1/2
E6XDB20/36+MAC67A	145	72,6	2279	1664	615	141	143	100	G2 1/2
E6XDB20/40+MAC67A	145	74,6	2399	1784	615	141	143	100	G2 1/2
E6XDB20/44+MAC67A	145	69,6	2519	1904	615	141	143	100	G2 1/2
E6XDB20/50+MAC610A	145	83,4	2754	2084	670	141	143	100	G2 1/2
E6XDB20/56+MAC610A	145	80,4	2934	2264	670	141	143	100	G2 1/2
E6XDB20/63+MAC612A	145	88,5	3174	2474	700	141	143	100	G2 1/2
E6XDB20/70+MAC612A	145	92,5	3384	2684	700	141	143	100	G2 1/2
E6XDB20/76+MAC615A	145	104	3579	2864	715	141	143	100	G2 1/2

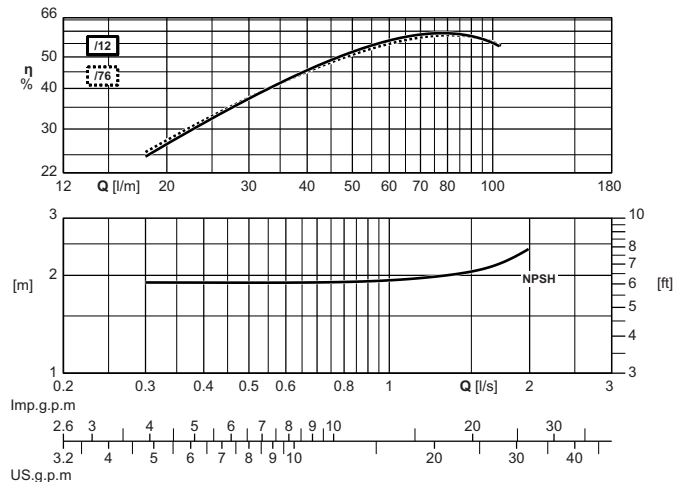
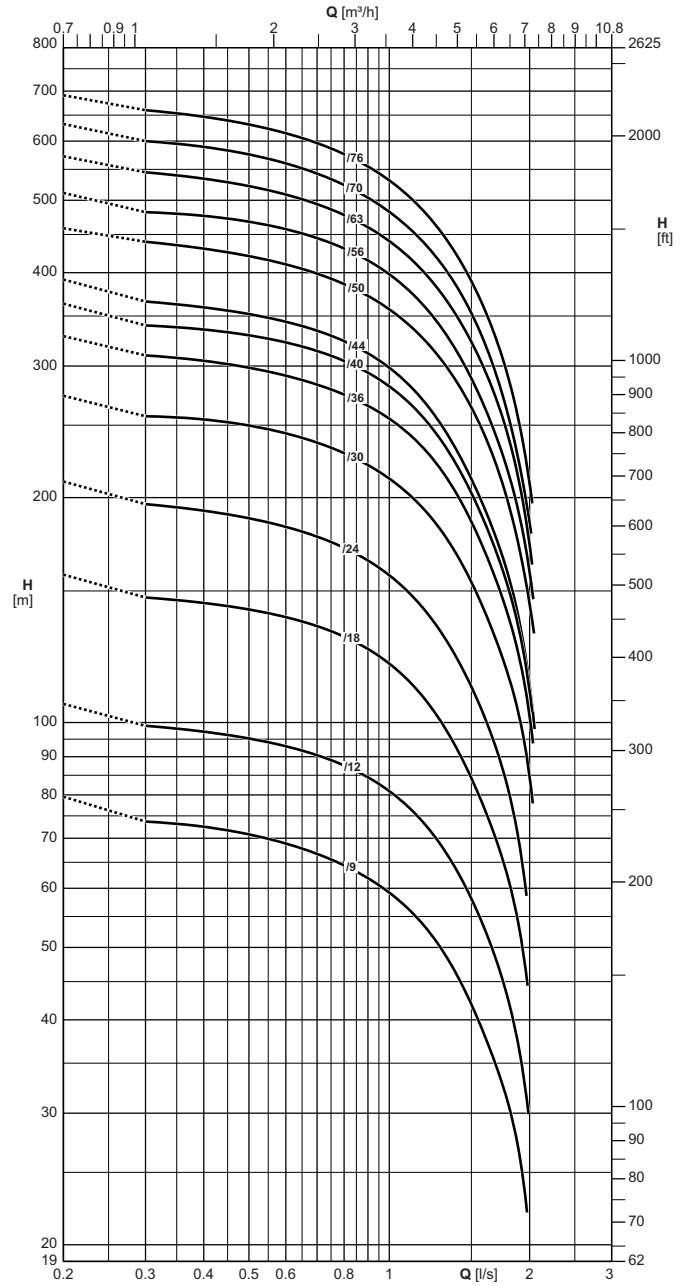

The hydraulic performance characteristics are guaranteed as conforming to standard UNI/ISO 9906 Grade 3B. Available with NPT thread.

Les caractéristiques hydrauliques de fonctionnement sont garanties conformes à la norme UNI/ISO 9906 Niveau 3B. Disponible avec filetage NPT.

Le caratteristiche di funzionamento vengono garantite secondo la norma: UNI/ISO 9906 Grado 3B. Disponibile con filettatura NPT.



Operating data
Caracteristiques de fonctionnement
Caratteristiche di funzionamento

Electric pump type Electropompe type Elettropompa tipo	Motor power Puis. moteur Potenza motore		Horizontal installation Installation horizontale Installazione orizzontale	Check valve Ø Clapet de retenue Ø Valvola di ritegno Ø	Capacity Debit Portata														
	[kW]	[HP]			[l/s]	0	0,3	0,4	0,5	0,6	0,7	0,8	0,9	1	1,2	1,4	1,6	1,8	2
					[l/min]	0	18	24	30	36	42	48	54	60	72	84	96	108	120
					[m³/h]	0	1,1	1,4	1,8	2,2	2,5	2,9	3,2	3,6	4,3	5	5,8	6,5	7,2
Head Hauteur Prevalenza																			
E6XD20/9+MCH415	1,1	1,5	n	2 1/2" Gas	[m]	79	74	73	71	69	68	64	61	59	54	47,5	37,5	31	22
E6XD20/12+MCH42	1,5	2	n	2 1/2" Gas	[m]	106	99	97	96	94	91	86	84	80	73	65	51	42	30
E6XD20/18+MCK43	2,2	3	n	2 1/2" Gas	[m]	158	147	145	142	139	136	129	124	119	108	95	75	61	44,5
E6XD20/24+MCR44	3	4	n	2 1/2" Gas	[m]	210	196	192	189	184	180	169	164	157	142	126	100	82	59
E6XD20/30+MCR455	4	5,5	n	2 1/2" Gas	[m]	274	257	255	251	245	239	233	218	209	190	168	144	121	78
E6XD20/30+MAC65A	4	5,5	n	2 1/2" Gas	[m]	274	257	255	251	245	239	233	218	209	190	168	144	121	78
E6XDB20/36+MAC67A	5,5	7,5	n	2 1/2" Gas	[m]	329	310	305	300	293	286	279	261	252	229	202	173	145	94
E6XDB20/40+MAC67A	5,5	7,5	n	2 1/2" Gas	[m]	364	340	336	331	325	317	309	290	278	252	222	190	159	103
E6XDB20/44+MAC67A	5,5	7,5	n	2 1/2" Gas	[m]	392	366	360	353	346	338	328	318	293	263	229	195	162	123
E6XDB20/50+MAC610A	7,5	10	n	2 1/2" Gas	[m]	459	440	431	423	413	403	391	379	352	320	284	246	204	157
E6XDB20/56+MAC610A	7,5	10	n	2 1/2" Gas	[m]	511	482	477	470	460	449	437	409	392	355	314	270	225	146
E6XDB20/63+MAC612A	9,2	12,5	m	2 1/2" Gas	[m]	572	545	535	525	513	500	485	453	435	396	351	305	255	163
E6XDB20/70+MAC612A	9,2	12,5	m	2 1/2" Gas	[m]	632	600	591	579	565	550	533	497	477	434	387	334	245	179
E6XDB20/76+MAC615A	11	15	m	2 1/2" Gas	[m]	691	660	648	634	619	603	586	547	525	477	424	367	306	196
NPSH					[m]	-	1,9	1,9	1,9	1,9	1,9	1,9	1,9	1,9	2	2	2,1	2,2	2,4

M.E.I. ≥ 0.40

n Without conical valve

o On request

m Please contact our sales organisation

For motor performances specification see page "motor features"

n Sans soupape du clapet.

o Sur demande

m Contacter notre service commercial.

Pour caractéristiques techniques moteurs voir page "Caractéristiques des moteurs"

n Senza clapet valvola di ritegno

o Su richiesta

m Interpellare la sede o la rete di vendita

Per caratteristiche motori vedere pagina caratteristiche motori

Temperature monitoring device for submersed electric motors 4" ÷ 6":
see page "Accessories"

Appareillage de contrôle de la température des moteurs électriques
immergés 4" ÷ 6": voir page "Accessories"

Apparecchiatura di controllo temperatura motori elettrici
sommersi 4" ÷ 6": vedere pagina accessori

Operating data
Caracteristiques de fonctionnement
Caratteristiche di funzionamento

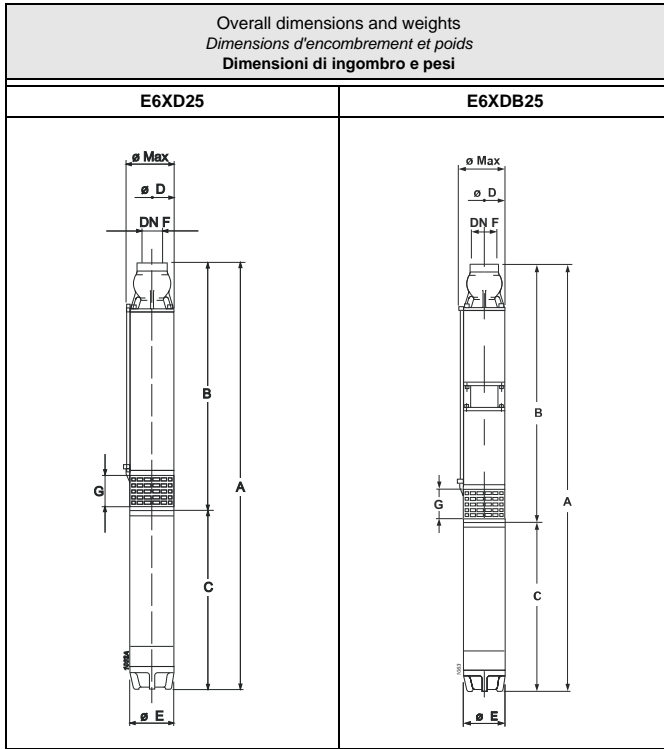

Type Type Tipo	Ø max [mm]	Weight Poids Peso [kg]	A	B	C	D	E	G	F
E6XD25/77+MCH42	135	21,4	894	508	386	127	96	-	G2 1/2
E6XD25/10+MCH43	135	23,9	1048	598	450	127	96	-	G2 1/2
E6XD25/13+MCK44	135	26,6	1138	688	450	127	96	-	G2 1/2
E6XD25/17+MCR455	135	29,6	1372	867	505	127	96	-	G2 1/2
E6XD25/17+MAC65A	145	51,2	1472	902	570	141	143	100	G2 1/2
E6XD25/21+MCR475	135	42,7	1687	987	700	127	96	-	G2 1/2
E6XD25/21+MAC67A	145	58,6	1637	1022	615	141	143	100	G2 1/2
E6XD25/24+MCR475	135	44,2	1777	1077	700	127	96	-	G2 1/2
E6XD25/24+MAC67A	145	62,6	1727	1112	615	141	143	100	G2 1/2
E6XD25/28+MAC610A	145	69,4	1902	1232	670	141	143	100	G2 1/2
E6XD25/32+MAC610A	145	71,4	2022	1352	670	141	143	100	G2 1/2
E6XDB25/36+MAC612A	145	73,5	2364	1664	700	141	143	100	G2 1/2
E6XDB25/40+MAC612A	145	61,7	2484	1784	700	141	143	100	G2 1/2
E6XDB25/44+MAC615A	145	81,3	2619	1904	715	141	143	100	G2 1/2
E6XDB25/50+MAC615A	145	92	2799	2084	715	141	143	100	G2 1/2
E6XDB25/56+MAC617A	145	91,8	3014	2264	750	141	143	100	G2 1/2
E6XDB25/63+MAC620A	145	96,8	3264	2474	790	141	143	100	G2 1/2

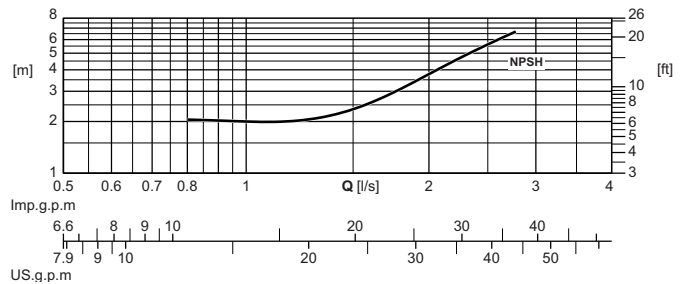
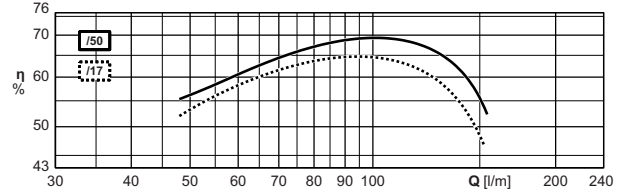
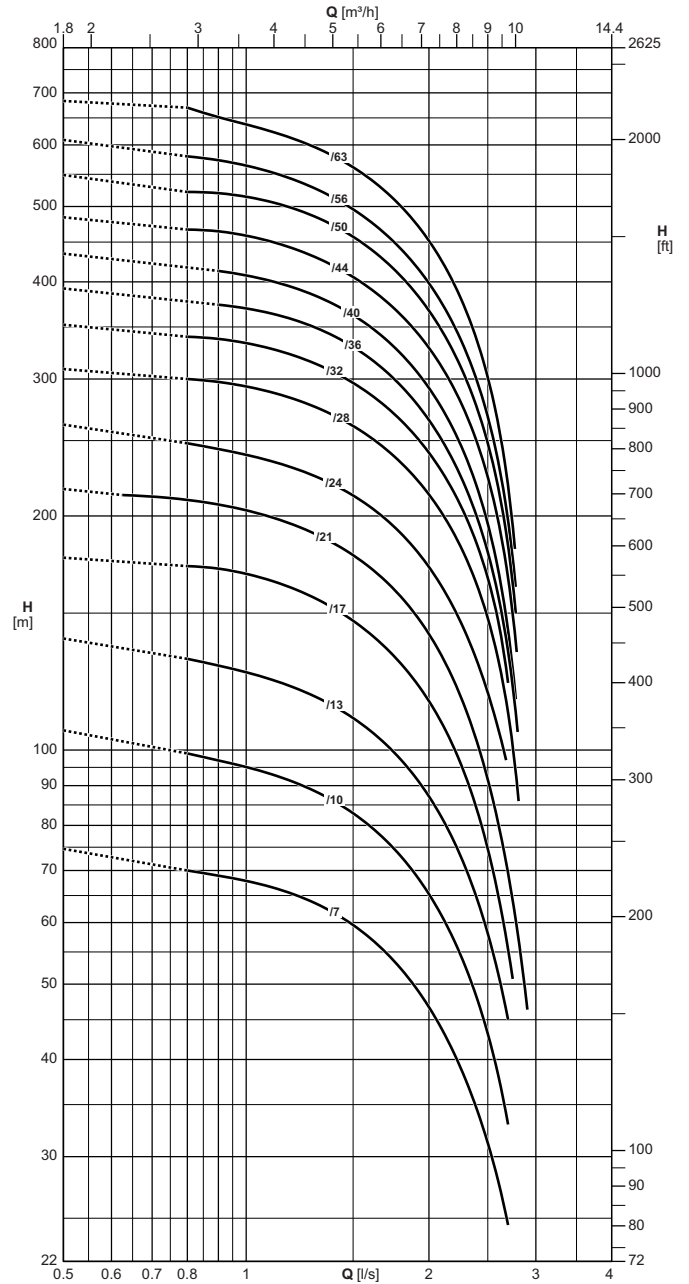

The hydraulic performance characteristics are guaranteed as conforming to standard UNI/ISO 9906 Grade 3B. Available with NPT thread.

Les caractéristiques hydrauliques de fonctionnement sont garanties conformes à la norme UNI/ISO 9906 Niveau 3B. Disponible avec filetage NPT.

Le caratteristiche di funzionamento vengono garantite secondo la norma: UNI/ISO 9906 Grado 3B. Disponibile con filettatura NPT.



Operating data
Caracteristiques de fonctionnement
Caratteristiche di funzionamento

Electric pump type Electropompe type Elettropompa tipo	Motor power Puis. moteur Potenza motore		Horizontal installation Installation horizontale Installazione orizzontale	Check valve Ø Clapet de retenue Ø Valvola di ritegno Ø	Capacity Debit Portata														
	[kW]	[HP]			[l/s]	0	0,7	0,8	0,9	1	1,2	1,4	1,6	1,8	2	2,2	2,4	2,6	2,8
					[l/min]	0	42	48	54	60	72	84	96	108	120	132	144	156	168
					[m³/h]	0	2,5	2,9	3,2	3,6	4,3	5	5,8	6,5	7,2	7,9	8,6	9,4	10,1
Head Hauteur Prevalenza																			
E6XD25/7+MCH42	1,5	2	n	2½" Gas	[m]	74	-	70	69	68	65	62	57	52	46,5	40,5	34,5	28	-
E6XD25/10+MCH43	2,2	3	n	2½" Gas	[m]	106	-	99	97	95	91	86	80	73	65	57	48	38	-
E6XD25/13+MCK44	3	4	m	2½" Gas	[m]	139	-	131	128	126	120	114	106	97	87	76	64	52	-
E6XD25/17+MCR455	4	5,5	n	2½" Gas	[m]	177	-	172	171	168	161	151	140	127	113	98	80	61	-
E6XD25/17+MAC65A	4	5,5	n	2½" Gas	[m]	187	-	178	175	172	165	157	148	136	124	110	94	78	-
E6XD25/21+MCR475	5,5	7,5	n	2½" Gas	[m]	216	211	209	208	204	193	184	172	155	140	124	100	80	60
E6XD25/21+MAC67A	5,5	7,5	n	2½" Gas	[m]	231	-	219	215	212	203	193	182	168	153	136	117	96	-
E6XD25/24+MCR475	5,5	7,5	n	2½" Gas	[m]	262	-	248	244	240	230	219	206	191	173	153	132	109	-
E6XD25/24+MAC67A	5,5	7,5	n	2½" Gas	[m]	262	-	248	244	240	230	219	206	191	173	153	132	109	-
E6XD25/28+MAC610A	7,5	10	n	2½" Gas	[m]	309	-	300	297	293	281	266	248	239	217	193	165	131	86
E6XD25/32+MAC610A	7,5	10	n	2½" Gas	[m]	352	-	340	338	334	321	306	287	265	241	214	184	147	-
E6XDB25/36+MAC612A	9,2	12,5	n	2½" Gas	[m]	392	-	-	374	370	357	340	319	294	266	234	199	158	105
E6XDB25/40+MAC612A	9,2	12,5	n	2½" Gas	[m]	435	-	-	413	408	393	374	351	324	294	260	221	175	116
E6XDB25/44+MAC615A	11	15	n	2½" Gas	[m]	484	-	467	464	458	439	415	387	355	337	299	255	203	134
E6XDB25/50+MAC615A	11	15	n	2½" Gas	[m]	549	-	522	520	514	495	468	436	398	367	334	285	227	150
E6XDB25/56+MAC617A	13	17,5	m	2½" Gas	[m]	609	-	580	573	563	539	508	472	432	387	363	309	245	162
E6XDB25/63+MAC620A	15	20	m	2½" Gas	[m]	683	-	670	651	637	608	575	536	491	440	397	350	277	181
NPSH					[m]	-	2,1	2	2	2	2	2,2	2,5	3	3,6	4,2	4,9	5,8	6,7

M.E.I. ≥ 0.40

n Without conical valve

o On request

m Please contact our sales organisation

For motor performances specification see page "motor features"

n Sans soupape du clapet.

o Sur demande

m Contacter notre service commercial.

Pour caractéristiques techniques moteurs voir page "Caractéristiques des moteurs"

n Senza clapet valvola di ritegno

o Su richiesta

m Interpellare la sede o la rete di vendita

Per caratteristiche motori vedere pagina caratteristiche motori

Temperature monitoring device for submersed electric motors 4" ÷ 6": Appareillage de contrôle de la température des moteurs électriques immergés 4" ÷ 6": voir page "Accessories"

Apparecchiatura di controllo temperatura motori elettrici sommersi 4" ÷ 6": vedere pagina accessori

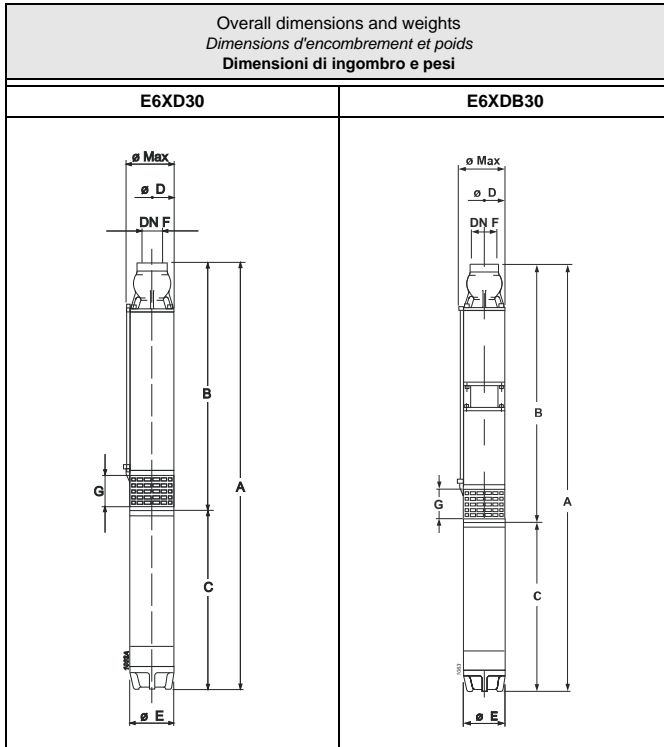

Type Type Tipo	Ø max [mm]	Weight Poids Peso [kg]	A	B	C	D	E	G	F
E6XD30/5+MCH42	135	18,5	859	473	386	127	96	-	G2 1/2
E6XD30/8+MCH43	135	21,9	1028	578	450	127	96	-	G2 1/2
E6XD30/10+MCK44	135	27,9	1098	648	450	127	96	-	G2 1/2
E6XD30/13+MCR455	135	28,4	1317	812	505	127	96	-	G2 1/2
E6XD30/13+MAC65A	145	50	1417	847	570	141	143	100	G2 1/2
E6XD30/16+MCR475	135	72,6	1617	917	700	127	96	-	G2 1/2
E6XD30/16+MAC67A	145	59,6	1567	952	615	141	143	100	G2 1/2
E6XD30/18+MCR475	135	41	1687	987	700	127	96	-	G2 1/2
E6XD30/18+MAC67A	145	58,6	1637	1022	615	141	143	100	G2 1/2
E6XD30/21+MCR410	135	50	1892	1092	800	127	96	-	G2 1/2
E6XD30/21+MAC610A	145	64,2	1797	1127	670	141	143	100	G2 1/2
E6XD30/24+MCR410	135	51	1997	1197	800	127	96	-	G2 1/2
E6XD30/24+MAC610A	145	68,4	1902	1232	670	141	143	100	G2 1/2
E6XD30/28+MAC612A	145	72,3	2072	1372	700	141	143	100	G2 1/2
E6XD30/31+MAC612A	145	76,7	2177	1477	700	141	143	100	G2 1/2
E6XD30/36+MAC615A	145	80	2367	1652	715	141	143	100	G2 1/2
E6XDB30/42+MAC617A	145	92,2	2804	2054	750	141	143	100	G2 1/2
E6XDB30/47+MAC620A	145	100,8	3019	2229	790	141	143	100	G2 1/2
E6XDB30/52+MAC625A	145	107,7	3234	2404	830	141	143	100	G2 1/2
E6XDB30/56+MAC625A	145	109,2	3374	2544	830	141	143	100	G2 1/2
E6XDB30/60+MAC625A	145	113,2	3514	2684	830	141	143	100	G2 1/2
E6XDB30/65+MAC630A	145	127,5	3779	2859	920	141	143	100	G2 1/2

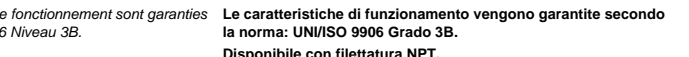
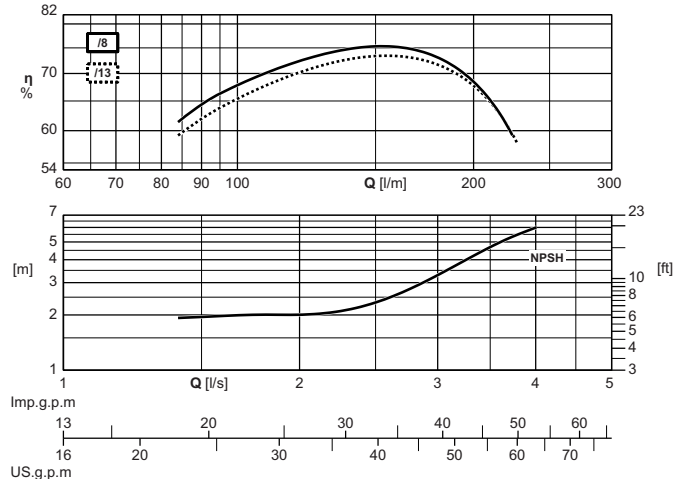
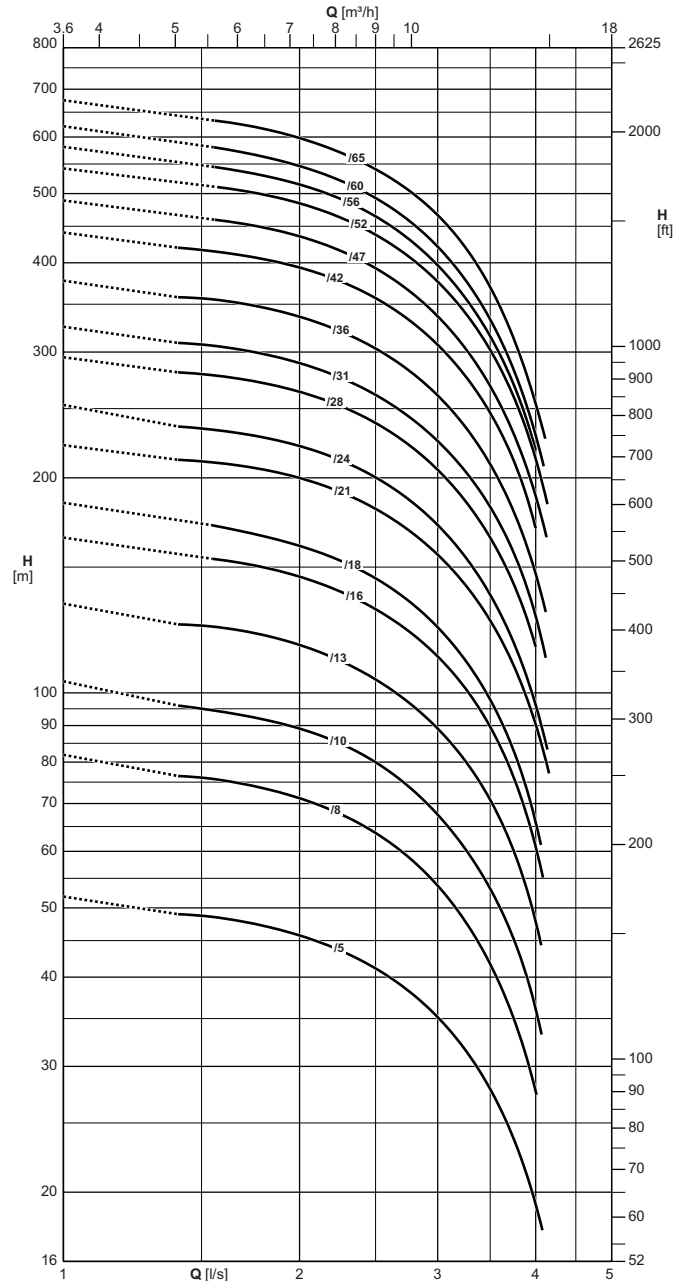

The hydraulic performance characteristics are guaranteed as conforming to standard UNI/ISO 9906 Grade 3B. Available with NPT thread.

Les caractéristiques hydrauliques de fonctionnement sont garanties conformes à la norme UNI/ISO 9906 Niveau 3B. Disponible avec filetage NPT.

Le caratteristiche di funzionamento vengono garantite secondo la norma: UNI/ISO 9906 Grado 3B. Disponibile con filettatura NPT.



Operating data
Caracteristiques de fonctionnement
Caratteristiche di funzionamento

Electric pump type Electropompe type Elettropompa tipo	Motor power Puis. moteur Potenza motore		Horizontal installation Installation horizontale Installazione orizzontale	Check valve Ø Clapet de retenue Ø Valvola di ritegno Ø	Capacity Debit Portata												
	[kW]	[HP]			[l/s]	0	1,4	1,6	1,8	2	2,2	2,4	2,6	2,8	3	3,5	4
					[l/min]	0	84	96	108	120	132	144	156	168	180	210	240
					[m³/h]	0	5	5,8	6,5	7,2	7,9	8,6	9,4	10,1	10,8	12,6	14,4
		Head Hauteur Prevalenza															
		[m]	52	49	48,5	47	46	43,5	42,5	40	37,5	36	27,5	19			
E6XD30/5+MCH42	1,5	2	n	2 1/2" Gas	[m]	52	49	48,5	47	46	43,5	42,5	40	37,5	36	27,5	19
E6XD30/8+MCH43	2,2	3	n	2 1/2" Gas	[m]	82	76	75	73	71	68	66	61	58	53	42,5	27,5
E6XD30/10+MCK44	3	4	m	2 1/2" Gas	[m]	104	96	94	91	90	85	82	78	73	67	53	36
E6XD30/13+MCR455	4	5,5	n	2 1/2" Gas	[m]	133	125	123	120	117	111	107	102	95	88	71	48
E6XD30/13+MAC65A	4	5,5	n	2 1/2" Gas	[m]	137	131	129	126	123	119	113	109	101	96	77	55
E6XD30/16+MCR475	5,5	7,5	n	2 1/2" Gas	[m]	165	-	154	149	146	140	136	127	122	112	90	64
E6XD30/16+MAC67A	5,5	7,5	n	2 1/2" Gas	[m]	168	160	157	154	151	145	139	134	123	117	94	67
E6XD30/18+MCR475	5,5	7,5	n	2 1/2" Gas	[m]	184	-	170	165	160	155	148	141	132	123	96	66
E6XD30/18+MAC67A	5,5	7,5	n	2 1/2" Gas	[m]	189	179	176	172	169	163	156	147	138	132	102	75
E6XD30/21+MCR410	7,5	10	n	2 1/2" Gas	[m]	222	212	209	204	200	193	184	178	167	156	126	89
E6XD30/21+MAC610A	7,5	10	n	2 1/2" Gas	[m]	222	212	209	204	200	193	184	178	167	156	126	89
E6XD30/24+MCR410	7,5	10	n	2 1/2" Gas	[m]	253	236	232	227	222	214	205	197	181	172	138	96
E6XD30/24+MAC610A	7,5	10	n	2 1/2" Gas	[m]	253	236	232	227	222	214	205	197	181	172	138	96
E6XD30/28+MAC612A	9,2	12,5	n	2 1/2" Gas	[m]	295	281	277	271	263	254	247	230	221	202	169	116
E6XD30/31+MAC612A	9,2	12,5	n	2 1/2" Gas	[m]	325	309	304	297	291	280	267	253	238	227	177	131
E6XD30/36+MAC615A	11	15	n	2 1/2" Gas	[m]	378	358	353	345	338	325	311	294	276	263	203	150
E6XDB30/42+MAC617A	13	17,5	n	2 1/2" Gas	[m]	441	420	413	404	393	379	369	345	332	302	253	170
E6XDB30/47+MAC620A	15	20	n	2 1/2" Gas	[m]	489	-	460	446	438	417	405	378	363	331	276	189
E6XDB30/52+MAC625A	18,5	25	n	2 1/2" Gas	[m]	542	-	511	496	486	464	450	428	404	378	308	212
E6XDB30/56+MAC625A	18,5	25	m	2 1/2" Gas	[m]	581	-	545	529	514	497	477	454	420	401	318	219
E6XDB30/60+MAC625A	18,5	25	m	2 1/2" Gas	[m]	621	-	581	561	550	525	510	477	458	417	334	238
E6XDB30/65+MAC630A	22	30	m	2 1/2" Gas	[m]	675	-	633	614	602	573	558	523	503	460	368	259
NPSH					[m]	-	1,8	2	2	2	2,2	2,2	2,4	2,7	3,1	4,5	5,9

M.E.I. ≥ 0.40

n Without conical valve

o On request

m Please contact our sales organisation

For motor performances specification see page "motor features"

Temperature monitoring device for submersed electric motors 4" ÷ 6": see page "Accessories"

n Sans soupape du clapet.

o Sur demande

m Contacter notre service commercial.

Pour caractéristiques techniques moteurs voir page "Caractéristiques des moteurs"

Appareillage de contrôle de la température des moteurs électriques immergés 4" ÷ 6": voir page "Accessories"

n Senza clapet valvola di ritegno

o Su richiesta

m Interpellare la sede o la rete di vendita

Per caratteristiche motori vedere pagina caratteristiche motori

Apparecchiatura di controllo temperatura motori elettrici sommersi 4" ÷ 6": vedere pagina accessori

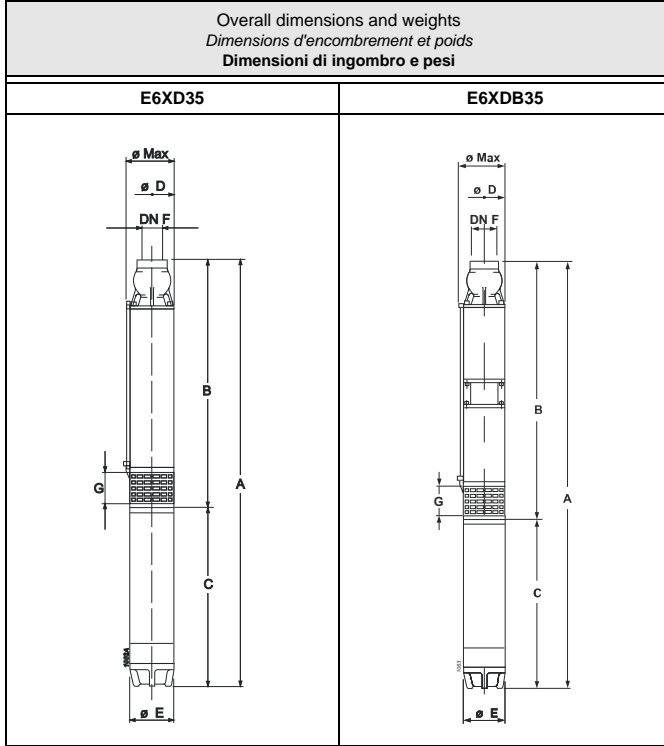

Type Type Tipo	Ø max [mm]	Weight Poids Peso [kg]	A	B	C	D	E	G	F
E6XD35/3+MCH415	135	16,2	773	403	370	127	96	-	G2 1/2
E6XD35/4+MCH42	135	18,2	824	438	386	127	96	-	G2 1/2
E6XD35/6+MCH43	135	20,7	958	508	450	127	96	-	G2 1/2
E6XD35/7+MCK44	135	25,4	993	543	450	127	96	-	G2 1/2
E6XD35/9+MCR455	135	26,1	1118	613	505	127	96	-	G2 1/2
E6XD35/9+MAC65A	145	46,9	1218	648	570	141	143	100	G2 1/2
E6XD35/11+MCR475	135	37,7	1383	683	700	127	96	-	G2 1/2
E6XD35/11+MAC67A	145	54,6	1333	718	615	141	143	100	G2 1/2
E6XD35/13+MCR475	135	37,7	1512	812	700	127	96	-	G2 1/2
E6XD35/13+MAC67A	145	54,6	1462	847	615	141	143	100	G2 1/2
E6XD35/15+MCR410	135	45,6	1682	882	800	127	96	-	G2 1/2
E6XD35/15+MAC610A	145	61	1587	917	670	141	143	100	G2 1/2
E6XD35/18+MCR410	135	46,5	1787	987	800	127	96	-	G2 1/2
E6XD35/18+MAC610A	145	62	1692	1022	670	141	143	100	G2 1/2
E6XD35/22+MAC612A	145	70,7	1862	1162	700	141	143	100	G2 1/2
E6XD35/26+MAC615A	145	77	2017	1302	715	141	143	100	G2 1/2
E6XD35/31+MAC617A	145	85	2227	1477	750	141	143	100	G2 1/2
E6XD35/35+MAC620A	145	87,8	2407	1617	790	141	143	100	G2 1/2
E6XDB35/40+MAC625A	145	100,2	2814	1984	830	141	143	100	G2 1/2
E6XDB35/44+MAC625A	145	102,2	2954	2124	830	141	143	100	G2 1/2
E6XDB35/48+MAC630A	145	116,5	3184	2264	920	141	143	100	G2 1/2
E6XDB35/52+MAC630A	145	117,3	3324	2404	920	141	143	100	G2 1/2
E6XDB35/56+MAC630A	145	119,7	3464	2544	920	141	143	100	G2 1/2
E6XDB35/60+MAC635A	145	136,8	3739	2684	1055	141	143	100	G2 1/2
E6XDB35/65+MAC635A	145	137,3	3914	2859	1055	141	143	100	G2 1/2

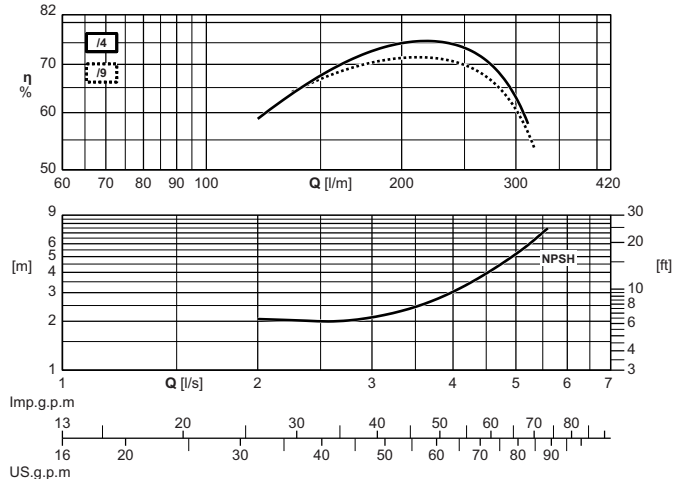
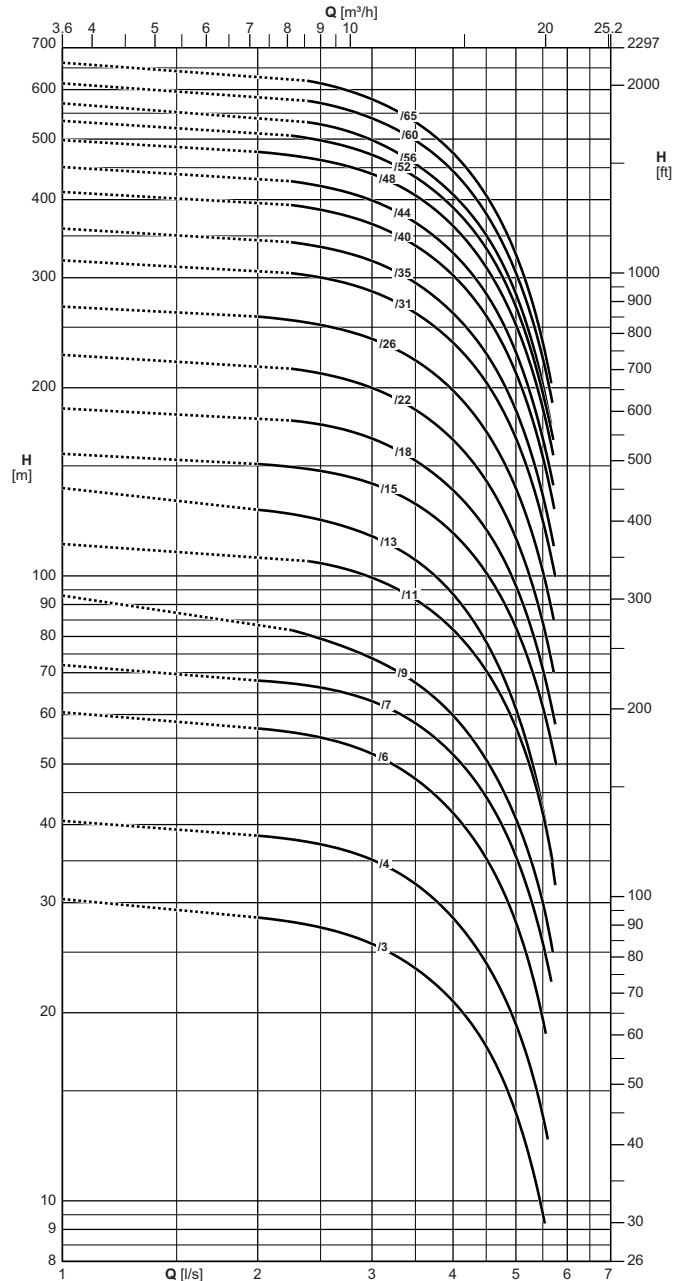

The hydraulic performance characteristics are guaranteed as conforming to standard UNI/ISO 9906 Grade 3B. Available with NPT thread.

Les caractéristiques hydrauliques de fonctionnement sont garanties conformes à la norme UNI/ISO 9906 Niveau 3B. Disponible avec filetage NPT.

Le caratteristiche di funzionamento vengono garantite secondo la norma: UNI/ISO 9906 Grado 3B. Disponibile con filettatura NPT.



Operating data
Caracteristiques de fonctionnement
Caratteristiche di funzionamento

Electric pump type Electropompe type Elettropompa tipo	Motor power Puis. moteur Potenza motore		Horizontal installation Installation horizontale Installazione orizzontale	Check valve Ø Clapet de retenue Ø Valvola di ritegno Ø	Capacity Debit Portata												
	[kW]	[HP]			[l/s]	0	2	2,2	2,4	2,6	2,8	3	3,5	4	4,5	5	5,5
					[l/min]	0	120	132	144	156	168	180	210	240	270	300	330
					[m³/h]	0	7,2	7,9	8,6	9,4	10,1	10,8	12,6	14,4	16,2	18	19,8
		Head Hauteur Prevalenza															
E6XD35/3+MCH415	1,1	1,5	n	2 1/2" Gas	[m]	30,5	28,5	28	27,5	27	26,5	25,5	23,5	20,5	17,5	14	9,2
E6XD35/4+MCH42	1,5	2	n	2 1/2" Gas	[m]	40,5	38,5	38	37,5	37	36,5	35	32	28,5	24,5	19	13,5
E6XD35/6+MCH43	2,2	3	n	2 1/2" Gas	[m]	60	57	56	56	55	53	52	47,5	42	35	28	20
E6XD35/7+MCK44	3	4	m	2 1/2" Gas	[m]	72	68	67	67	66	65	63	58	51	44	35,5	26,5
E6XD35/9+MCR455	4	5,5	n	2 1/2" Gas	[m]	93	-	-	80	78	76	74	67	60	50	41,5	29,5
E6XD35/9+MAC65A	4	5,5	n	2 1/2" Gas	[m]	94	90	89	88	87	86	84	78	70	61	50	37,5
E6XD35/11+MCR475	5,5	7,5	n	2 1/2" Gas	[m]	112	-	-	105	104	101	99	91	83	71	57	41
E6XD35/11+MAC67A	5,5	7,5	n	2 1/2" Gas	[m]	115	110	109	108	107	104	102	95	84	74	61	49
E6XD35/13+MCR475	5,5	7,5	n	2 1/2" Gas	[m]	138	127	126	124	122	119	116	106	94	79	63	44
E6XD35/13+MAC67A	5,5	7,5	n	2 1/2" Gas	[m]	135	128	127	126	124	122	119	111	100	83	67	49,5
E6XD35/15+MCR410	7,5	10	n	2 1/2" Gas	[m]	157	151	150	148	146	144	141	130	117	102	83	63
E6XD35/15+MAC610A	7,5	10	n	2 1/2" Gas	[m]	157	151	150	148	146	144	141	130	117	102	83	63
E6XD35/18+MCR410	7,5	10	n	2 1/2" Gas	[m]	185	-	-	175	173	170	166	152	137	120	96	72
E6XD35/18+MAC610A	7,5	10	n	2 1/2" Gas	[m]	185	-	-	175	173	170	166	152	137	120	96	72
E6XD35/22+MAC612A	9,2	12,5	n	2 1/2" Gas	[m]	226	-	-	212	209	205	200	183	166	140	115	82
E6XD35/26+MAC615A	11	15	n	2 1/2" Gas	[m]	270	260	257	254	250	245	240	222	200	167	135	100
E6XD35/31+MAC617A	13	17,5	n	2 1/2" Gas	[m]	320	-	-	302	297	292	286	261	236	207	165	125
E6XD35/35+MAC620A	15	20	n	2 1/2" Gas	[m]	359	-	-	338	333	327	320	293	264	224	185	131
E6XDB35/40+MAC625A	18,5	25	n	2 1/2" Gas	[m]	411	-	-	387	381	375	366	336	303	257	211	149
E6XDB35/44+MAC625A	18,5	25	n	2 1/2" Gas	[m]	451	-	-	423	416	409	400	366	330	280	230	162
E6XDB35/48+MAC630A	22	30	n	2 1/2" Gas	[m]	498	477	472	467	460	451	441	409	368	307	249	183
E6XDB35/52+MAC630A	22	30	n	2 1/2" Gas	[m]	535	-	-	500	493	484	473	432	390	331	272	192
E6XDB35/56+MAC630A	22	30	m	2 1/2" Gas	[m]	570	-	-	532	525	511	499	456	405	357	287	204
E6XDB35/60+MAC635A	26	35	m	2 1/2" Gas	[m]	614	-	-	576	568	552	540	495	450	383	306	220
E6XDB35/65+MAC635A	26	35	m	2 1/2" Gas	[m]	662	-	-	620	611	593	580	532	471	412	331	237
NPSH					[m]	-	1,8	2,2	2,1	2	2	2,2	2,2	2,9	3,8	5	6,9

M.E.I. ≥ 0.40

n Without conical valve

o On request

m Please contact our sales organisation

For motor performances specification see page "motor features"

n Sans soupape du clapet.

o Sur demande

m Contacter notre service commercial.

Pour caractéristiques techniques moteurs voir page "Caractéristiques des moteurs"

n Senza clapet valvola di ritegno

o Su richiesta

m Interpellare la sede o la rete di vendita

Per caratteristiche motori vedere pagina caratteristiche motori

Temperature monitoring device for submersed electric motors 4" ÷ 6": see page "Accessories"

Appareillage de contrôle de la température des moteurs électriques immergés 4" ÷ 6": voir page "Accessories"

Apparecchiatura di controllo temperatura motori elettrici sommersi 4" ÷ 6": vedere pagina accessori

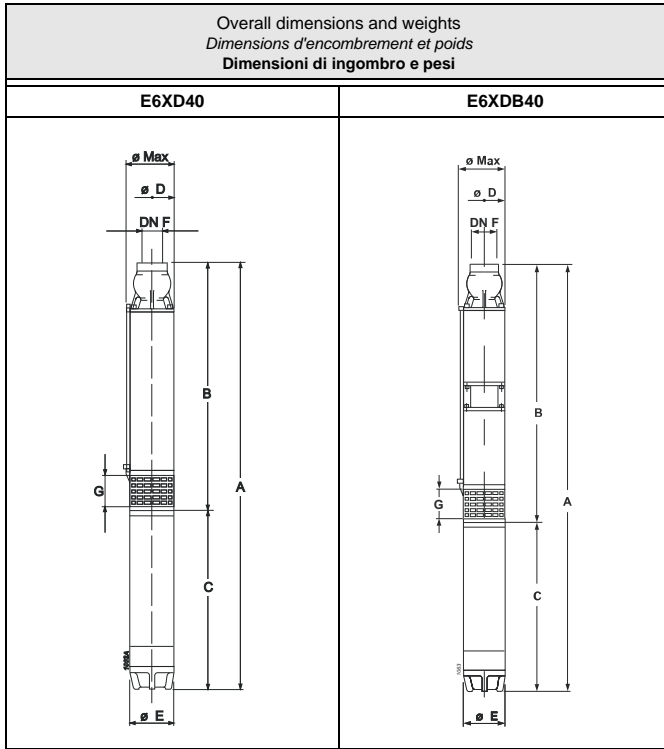

Type Type Tipo	Ø max [mm]	Weight Poids Peso [kg]	A	B	C	D	E	G	F
			[mm]						
E6XD40/3+MCH42	135	17,6	804	418	386	127	96	-	G2 1/2
E6XD40/4+MCH43	135	19,9	908	458	450	127	96	-	G2 1/2
E6XD40/6+MCK44	135	23,9	988	538	450	127	96	-	G2 1/2
E6XD40/8+MCR455	135	27,1	1123	618	505	127	96	-	G2 1/2
E6XD40/8+MAC65A	145	46,7	1223	653	570	141	143	100	G2 1/2
E6XD40/10+MCR475	135	36	1398	698	700	127	96	-	G2 1/2
E6XD40/10+MAC67A	145	54,6	1348	733	615	141	143	100	G2 1/2
E6XD40/13+MCR410	135	42,9	1677	877	800	127	96	-	G2 1/2
E6XD40/13+MAC610A	145	60,4	1582	912	670	141	143	100	G2 1/2
E6XD40/16+MAC612A	145	65,5	1732	1032	700	141	143	100	G2 1/2
E6XD40/20+MAC615A	145	73	1907	1192	715	141	143	100	G2 1/2
E6XD40/23+MAC617A	145	78,5	2062	1312	750	141	143	100	G2 1/2
E6XD40/26+MAC620A	145	82,8	2222	1432	790	141	143	100	G2 1/2
E6XD40/30+MAC625A	145	90,2	2422	1592	830	141	143	100	G2 1/2
E6XD40/33+MAC625A	145	92,5	2542	1712	830	141	143	100	G2 1/2
E6XDB40/38+MAC630A	145	112,5	3024	2104	920	141	143	100	G2 1/2
E6XDB40/42+MAC630A	145	114,5	3184	2264	920	141	143	100	G2 1/2
E6XDB40/44+MAC635A	145	127,3	3399	2344	1055	141	143	100	G2 1/2
E6XDB40/48+MAC635A	145	133,1	3559	2504	1055	141	143	100	G2 1/2
E6XDB40/51+MAC640A	145	141,9	3789	2624	1165	141	143	100	G2 1/2
E6XDB40/55+MAC640A	145	147,9	3949	2784	1165	141	143	100	G2 1/2
E6XDB40/60+MAC650B	145	168	4266	2984	1282	141	143	100	G2 1/2

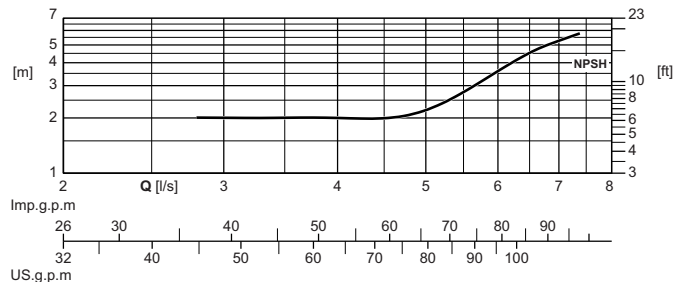
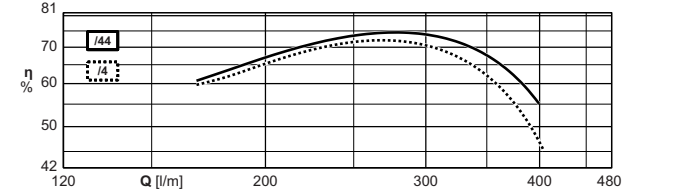
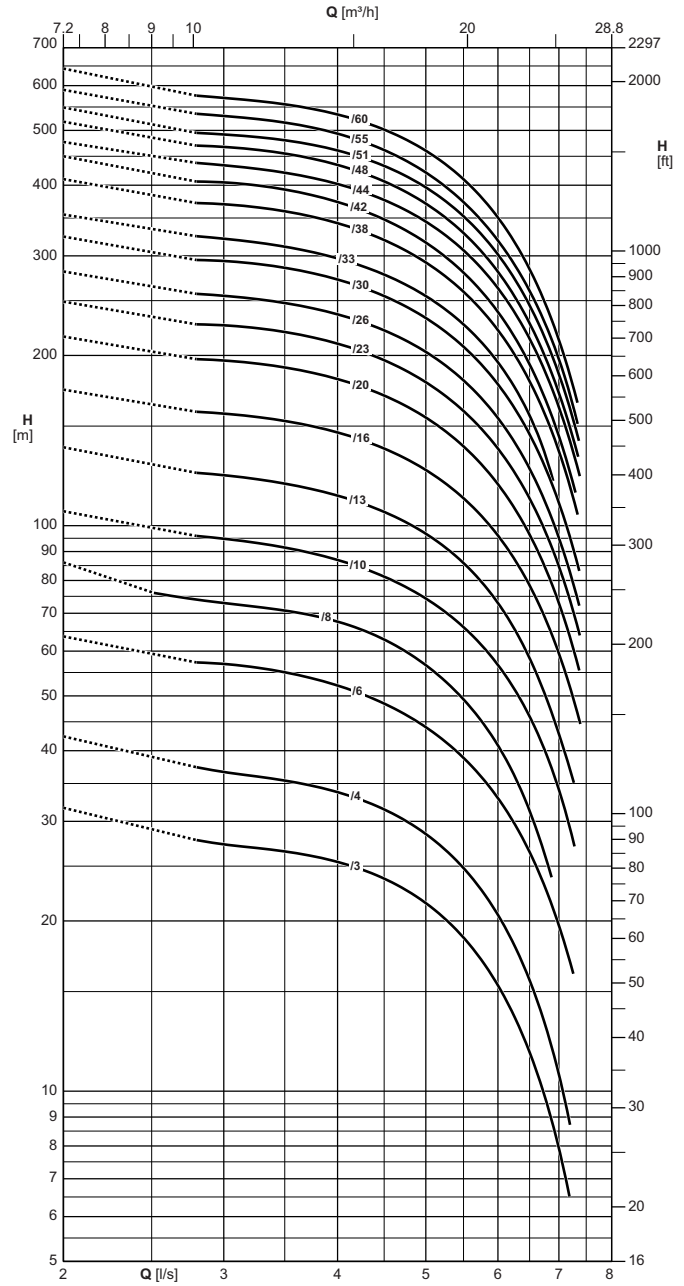

The hydraulic performance characteristics are guaranteed as conforming to standard UNI/ISO 9906 Grade 3B. Available with NPT thread.

Les caractéristiques hydrauliques de fonctionnement sont garanties conformes à la norme UNI/ISO 9906 Niveau 3B. Disponible avec filetage NPT.

Le caratteristiche di funzionamento vengono garantite secondo la norma: UNI/ISO 9906 Grado 3B. Disponibile con filettatura NPT.



Operating data
Caracteristiques de fonctionnement
Caratteristiche di funzionamento

Electric pump type Electropompe type Elettropompa tipo	Motor power Puis. moteur Potenza motore		Horizontal installation Installation horizontale Installazione orizzontale	Check valve Ø Clapet de retenue Ø Valvola di ritegno Ø	Capacity Debit Portata												
	[kW]	[HP]			[l/s]	0	2,6	2,8	3	3,5	4	4,5	5	5,5	6	6,5	7
					[l/min]	0	156	168	180	210	240	270	300	330	360	390	420
					[m³/h]	0	9,4	10,1	10,8	12,6	14,4	16,2	18	19,8	21,6	23,4	25,2
		Head Hauteur Prevalenza															
E6XD40/3+MCH42	1,5	2	n	2 1/2" Gas	[m]	31,5	-	28	27,5	26,5	25,5	23,5	21,5	18,5	15	11,5	8,2
E6XD40/4+MCH43	2,2	3	n	2 1/2" Gas	[m]	42,5	-	37,5	36,5	35,5	34	31,5	28,5	25	20	15,5	11
E6XD40/6+MCK44	3	4	m	2 1/2" Gas	[m]	64	-	57	57	55	52	48,5	43,5	39	33,5	27	19,5
E6XD40/8+MCR455	4	5,5	n	2 1/2" Gas	[m]	86	75	74	73	71	67	63	56	49,5	41,5	31	-
E6XD40/8+MAC65A	4	5,5	n	2 1/2" Gas	[m]	87	-	78	78	76	71	66	60	52	45	37	28,5
E6XD40/10+MCR475	5,5	7,5	n	2 1/2" Gas	[m]	106	-	96	94	91	87	82	74	66	57	46	33
E6XD40/10+MAC67A	5,5	7,5	n	2 1/2" Gas	[m]	108	-	98	97	95	90	85	78	68	59	47,5	36,5
E6XD40/13+MCR410	7,5	10	n	2 1/2" Gas	[m]	137	-	124	122	118	113	105	97	86	73	59	42
E6XD40/13+MAC610A	7,5	10	n	2 1/2" Gas	[m]	141	-	130	128	124	119	111	102	92	80	64	49
E6XD40/16+MAC612A	9,2	12,5	n	2 1/2" Gas	[m]	174	-	159	157	153	146	137	126	113	95	78	58
E6XD40/20+MAC615A	11	15	n	2 1/2" Gas	[m]	216	-	197	195	190	181	170	156	137	118	95	72
E6XD40/23+MAC617A	13	17,5	n	2 1/2" Gas	[m]	249	-	227	226	219	210	196	180	161	136	112	84
E6XD40/26+MAC620A	15	20	n	2 1/2" Gas	[m]	281	-	257	254	247	236	222	204	179	154	124	94
E6XD40/30+MAC625A	18,5	25	n	2 1/2" Gas	[m]	324	-	295	293	285	272	255	234	206	177	143	109
E6XD40/33+MAC625A	18,5	25	n	2 1/2" Gas	[m]	355	-	325	321	311	297	277	257	227	192	159	-
E6XDB40/38+MAC630A	22	30	n	2 1/2" Gas	[m]	410	-	372	370	359	343	321	295	258	219	180	137
E6XDB40/42+MAC630A	22	30	n	2 1/2" Gas	[m]	450	-	406	404	393	374	350	316	278	239	195	145
E6XDB40/44+MAC635A	26	35	m	2 1/2" Gas	[m]	477	-	438	433	420	402	377	347	311	261	214	160
E6XDB40/48+MAC635A	26	35	m	2 1/2" Gas	[m]	518	-	470	467	454	435	408	374	328	282	226	173
E6XDB40/51+MAC640A	30	40	m	2 1/2" Gas	[m]	549	-	495	491	480	461	434	399	350	301	242	185
E6XDB40/55+MAC640A	30	40	m	2 1/2" Gas	[m]	590	-	535	529	515	494	464	426	372	316	260	199
E6XDB40/60+MAC650B	37	50	m	2 1/2" Gas	[m]	643	-	576	570	555	534	504	457	409	347	284	216
NPSH					[m]	-	2,1	2	2	2	2	2,1	2,4	2,7	3,5	4,5	5,2

M.E.I. ≥ 0.40

n Without conical valve

o On request

m Please contact our sales organisation

For motor performances specification see page "motor features"

Temperature monitoring device for submersed electric motors 4" ÷ 6": see page "Accessories"

n Sans soupape du clapet.

o Sur demande

m Contacter notre service commercial.

Pour caractéristiques techniques moteurs voir page "Caractéristiques des moteurs"

Appareillage de contrôle de la température des moteurs électriques immergés 4" ÷ 6": voir page "Accessories"

n Senza clapet valvola di ritegno

o Su richiesta

m Interpellare la sede o la rete di vendita

Per caratteristiche motori vedere pagina caratteristiche motori

Apparecchiatura di controllo temperatura motori elettrici sommersi 4" ÷ 6": vedere pagina accessori

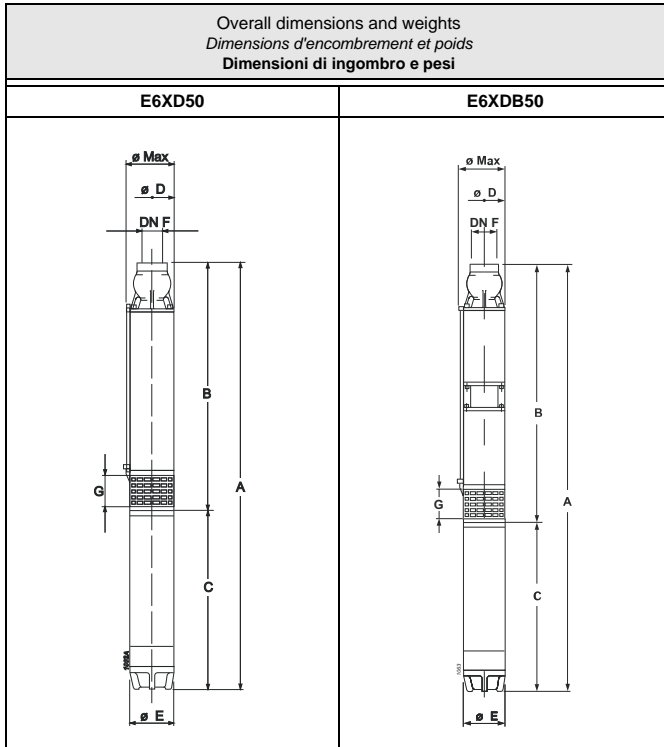

Type Type Tipo	\varnothing max	Weight Poids Peso	A	B	C	D	E	G	F
	[mm]								
E6XD50/3+MCH43	135	19,7	898	448	450	127	96	-	G2 1/2
E6XD50/4+MCK44	135	23,4	948	498	450	127	96	-	G2 1/2
E6XD50/5+MCR455	135	25,1	1053	548	505	127	96	-	G2 1/2
E6XD50/5+MAC65A	145	46,6	1153	583	570	141	143	100	G2 1/2
E6XD50/7+MCR475	135	35,4	1348	648	700	127	96	-	G2 1/2
E6XD50/7+MAC67A	145	54,6	1298	683	615	141	143	100	G2 1/2
E6XD50/10+MCR410	135	43	1657	857	800	127	96	-	G2 1/2
E6XD50/10+MAC610A	145	60	1562	892	670	141	143	100	G2 1/2
E6XD50/12+MAC612A	145	64,7	1692	992	700	141	143	100	G2 1/2
E6XD50/15+MAC615A	145	72	1857	1142	715	141	143	100	G2 1/2
E6XD50/17+MAC617A	145	76,7	1992	1242	750	141	143	100	G2 1/2
E6XD50/20+MAC620A	145	84,8	2182	1392	790	141	143	100	G2 1/2
E6XD50/25+MAC625A	145	92,2	2472	1642	830	141	143	100	G2 1/2
E6XDB50/30+MAC630A	145	111,5	3004	2084	920	141	143	100	G2 1/2
E6XDB50/35+MAC635A	145	129,3	3389	2334	1055	141	143	100	G2 1/2
E6XDB50/40+MAC640A	145	146,4	3749	2584	1165	141	143	100	G2 1/2
E6XDB50/45+MAC650B	145	166,9	4116	2834	1282	141	143	100	G2 1/2
E6XDB50/48+MAC650B	145	169,5	4266	2984	1282	141	143	100	G2 1/2

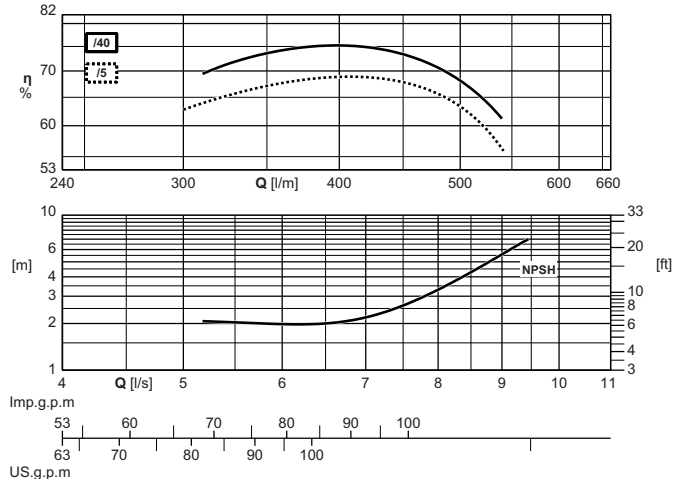
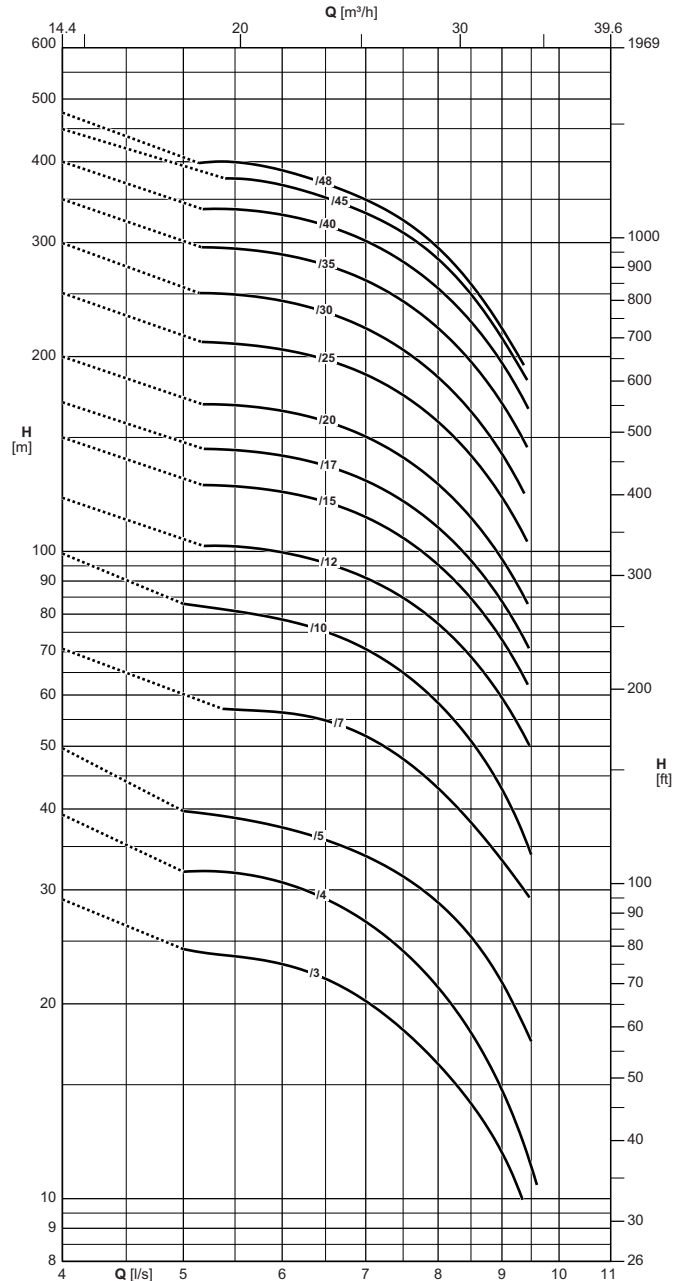

The hydraulic performance characteristics are guaranteed as conforming to standard UNI/ISO 9906 Grade 3B. Available with NPT thread.

Les caractéristiques hydrauliques de fonctionnement sont garanties conformes à la norme UNI/ISO 9906 Niveau 3B. Disponible avec filetage NPT.

Le caratteristiche di funzionamento vengono garantite secondo la norma: UNI/ISO 9906 Grado 3B. Disponibile con filettatura NPT.



Operating data
Caracteristiques de fonctionnement
Caratteristiche di funzionamento

Electric pump type Electropompe type Elettropompa tipo	Motor power Puis. moteur Potenza motore		Horizontal installation Installation horizontale Installazione orizzontale	Check valve Ø Clapet de retenue Ø Valvola di ritegno Ø	Capacity Debit Portata											
	[kW]	[HP]			[l/s]	0	5	5,5	6	6,5	7	7,5	8	8,5	9	9,5
					[l/min]	0	300	330	360	390	420	450	480	510	540	570
					[m³/h]	0	18	19,8	21,6	23,4	25,2	27	28,8	30,6	32,4	34,2
Head Hauteur Prevalenza																
E6XD50/3+MCH43	2,2	3	n	2½" Gas	[m]	29	24,5	23,5	23	22	20,5	18	16	14	11,5	-
E6XD50/4+MCK44	3	4	m	2½" Gas	[m]	39	32	32	31	29	26,5	24	21	18	15	11,5
E6XD50/5+MCR455	4	5,5	n	2½" Gas	[m]	49,5	39,5	39	37,5	36	34	31,5	28,5	25,5	21,5	17,5
E6XD50/5+MAC65A	4	5,5	n	2½" Gas	[m]	51	43,5	42	40,5	38,5	36,5	34	30,5	27	23,5	20
E6XD50/7+MCR475	5,5	7,5	n	2½" Gas	[m]	71	-	57	56	55	52	47,5	43,5	38	33	29
E6XD50/7+MAC67A	5,5	7,5	n	2½" Gas	[m]	70	-	59	58	56	53	49,5	45	40	34,5	29
E6XD50/10+MCR410	7,5	10	n	2½" Gas	[m]	99	83	81	78	75	70	65	58	51	42,5	34
E6XD50/10+MAC610A	7,5	10	n	2½" Gas	[m]	101	-	84	83	80	76	72	64	58	49	42
E6XD50/12+MAC612A	9,2	12,5	n	2½" Gas	[m]	121	-	102	100	95	91	84	77	69	59	50
E6XD50/15+MAC615A	11	15	n	2½" Gas	[m]	150	-	126	124	119	113	104	96	84	73	-
E6XD50/17+MAC617A	13	17,5	n	2½" Gas	[m]	170	-	143	141	135	129	119	109	97	83	71
E6XD50/20+MAC620A	15	20	n	2½" Gas	[m]	200	-	168	165	158	151	139	127	111	97	-
E6XD50/25+MAC625A	18,5	25	n	2½" Gas	[m]	251	-	209	205	197	188	173	159	139	122	-
E6XDB50/30+MAC630A	22	30	n	2½" Gas	[m]	299	-	249	243	235	221	205	184	165	141	-
E6XDB50/35+MAC635A	26	35	m	2½" Gas	[m]	350	-	293	288	277	263	242	222	195	170	-
E6XDB50/40+MAC640A	30	40	m	2½" Gas	[m]	400	-	337	332	318	303	280	255	228	195	166
E6XDB50/45+MAC650B	37	50	m	2½" Gas	[m]	449	-	376	367	353	333	310	282	251	213	-
E6XDB50/48+MAC650B	37	50	m	2½" Gas	[m]	476	-	399	387	371	348	326	292	260	221	-
NPSH					[m]	-	2	2	2	2,1	2,2	2,6	3,2	4,1	5,5	7

M.E.I. ≥ 0,40

n Without conical valve

o On request

m Please contact our sales organisation

For motor performances specification see page "motor features"

n Sans soupape du clapet.

o Sur demande

m Contacter notre service commercial.

Pour caractéristiques techniques moteurs voir page "Caractéristiques des moteurs"

n Senza clapet valvola di ritegno

o Su richiesta

m Interpellare la sede o la rete di vendita

Per caratteristiche motori vedere pagina caratteristiche motori

Temperature monitoring device for submersed electric motors 4" - 6": Appareillage de contrôle de la température des moteurs électriques immergés 4" - 6": voir page "Accessories"

Apparecchiatura di controllo temperatura motori elettrici sommersi 4" - 6": vedere pagina accessori

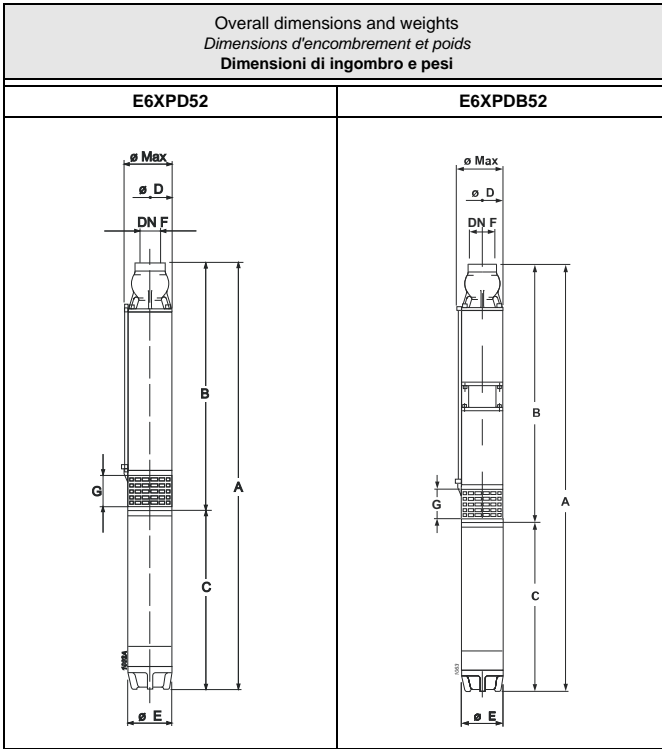

Type Type Tipo	Ø max [mm]	Weight Poids Peso [kg]	A	B	C	D	E	G	F
E6XPD52/2AB+MCH43	135	20,2	934	484	450	127	96	-	G3
E6XPD52/3B+MCK44	135	26,9	994	544	450	127	96	-	G3
E6XPD52/3A+MCR455	135	27	1049	544	505	127	96	-	G3
E6XPD52/3A+MAC65A	145	45,6	1114	544	570	141	143	100	G3
E6XPD52/4A+MCR475	135	35,7	1304	604	700	127	96	-	G3
E6XPD52/4A+MAC67A	145	51,6	1219	604	615	141	143	100	G3
E6XPD52/6K+MCR410	135	47	1524	724	800	127	96	-	G3
E6XPD52/6K+MAC610A	145	59,4	1394	724	670	141	143	100	G3
E6XPD52/7A+MAC612A	145	62,3	1484	784	700	141	143	100	G3
E6XPD52/9K+MAC615A	145	68,6	1678	963	715	141	143	100	G3
E6XPD52/10I+MAC617A	145	74,2	1773	1023	750	141	143	100	G3
E6XPD52/12K+MAC620A	145	80,7	1933	1143	790	141	143	100	G3
E6XPD52/14A+MAC625A	145	89,2	2093	1263	830	141	143	100	G3
E6XPDB52/17A+MAC630A	145	106,5	2570	1650	920	141	143	100	G3
E6XPDB52/19A+MAC635A	145	122,4	2825	1770	1055	141	143	100	G3
E6XPDB52/22A+MAC640A	145	159,2	3115	1950	1165	141	143	100	G3
E6XPDB52/25A+MAC650B	145	179	3412	2130	1282	141	143	100	G3
E6XPDB52/28A+MAC650B	145	161	3592	2310	1282	141	143	100	G3

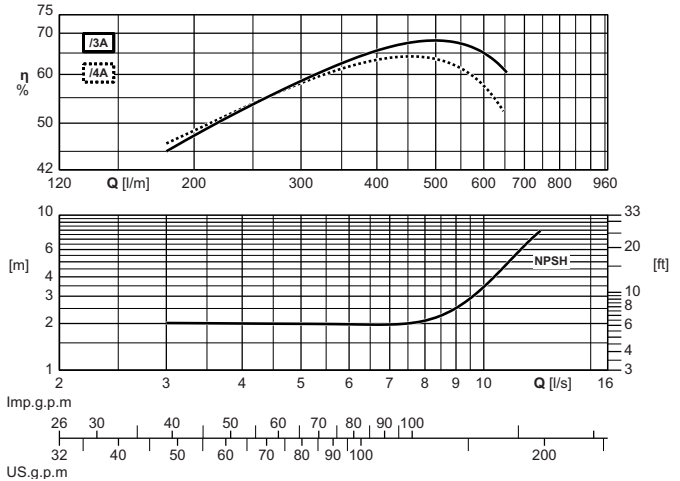
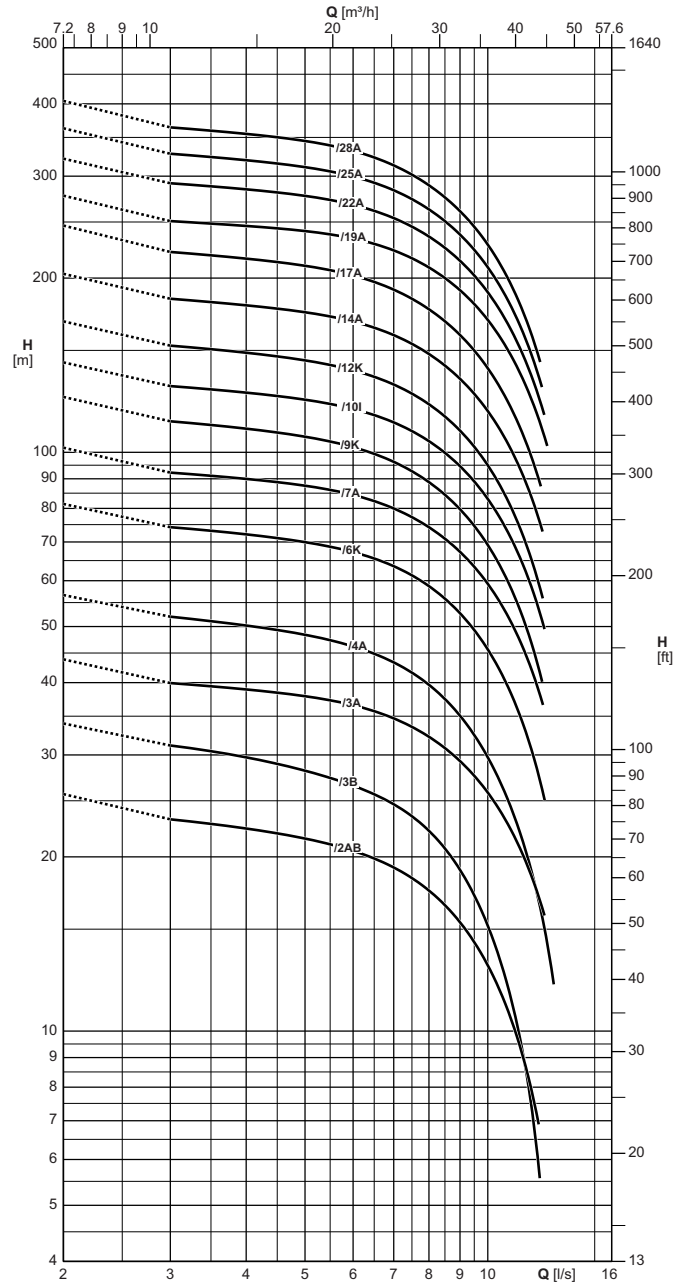

The hydraulic performance characteristics are guaranteed as conforming to standard UNI/ISO 9906 Grade 3B. Available with NPT thread.

Les caractéristiques hydrauliques de fonctionnement sont garanties conformes à la norme UNI/ISO 9906 Niveau 3B. Disponible avec filetage NPT.

Le caratteristiche di funzionamento vengono garantite secondo la norma: UNI/ISO 9906 Grado 3B. Disponibile con filettatura NPT.

Electric pump type Electropompe type Elettropompa tipo	Motor power Puis. moteur Potenza motore		Horizontal installation Installation horizontale Installazione orizzontale	Check valve Ø Clapet de retenue Ø Valvola di ritegno Ø	Capacity Debit Portata																		
	[kW]	[HP]			[l/s]	0	3	3,5	4	4,5	5	5,5	6	6,5	7	7,5	8	8,5	9	9,5	10	11	12
					[l/min]	0	180	210	240	270	300	330	360	390	420	450	480	510	540	570	600	660	720
					[m³/h]	0	10,8	12,6	14,4	16,2	18	19,8	21,6	23,4	25,2	27	28,8	30,6	32,4	34,2	36	39,6	43,2
Head Hauteur Prevalenza																							
E6XPD52/2AB+MCH43	2,2	3	n	3" Gas	[m]	25,5	23	23	22,5	22	21,5	21	20,5	20	19	18,5	17,5	16,5	15,5	14	13	10,5	7,2
E6XPD52/3B+MCK44	3	4	m	3" Gas	[m]	34	31	30,5	30	29	28	27,5	26,5	25,5	24,5	23,5	22	20,5	19	17	15	11	6,5
E6XPD52/3A+MCR455	4	5,5	n	3" Gas	[m]	44	40	39,5	39	38,5	38	37,5	36,5	36	35	33,5	32	30,5	29	27,5	25,5	22	17,5
E6XPD52/3A+MAC65A	4	5,5	n	3" Gas	[m]	44	40	39,5	39	38,5	38	37,5	36,5	35,5	35	33,5	32	30,5	29	27,5	25,5	22	17,5
E6XPD52/4A+MCR475	5,5	7,5	n	3" Gas	[m]	57	52	51	50	49,5	48,5	47,5	46	45	43	41,5	39,5	37,5	35	32,5	29,5	24	17,5
E6XPD52/4A+MAC67A	5,5	7,5	n	3" Gas	[m]	58	53	52	51	51	50	49,5	48	47	45,5	44	42,5	40,5	38,5	36,5	34	29	22,5
E6XPD52/6K+MCR410	7,5	10	n	3" Gas	[m]	81	74	73	72	71	70	69	67	66	64	61	59	56	52	49	45,5	37,5	28,5
E6XPD52/6K+MAC610A	7,5	10	n	3" Gas	[m]	81	74	73	72	71	70	69	67	66	64	61	59	56	52	49	45,5	37,5	28,5
E6XPD52/7A+MAC612A	9,2	12,5	n	3" Gas	[m]	102	92	91	90	89	87	86	84	82	80	77	74	71	67	63	59	50	39,5
E6XPD52/9K+MAC615A	11	15	n	3" Gas	[m]	124	113	111	110	108	106	104	102	99	96	93	89	84	80	75	69	57	44
E6XPD52/10I+MAC617A	13	17,5	n	3" Gas	[m]	143	130	128	127	125	123	121	119	116	113	109	104	99	94	89	83	70	55
E6XPD52/12K+MAC620A	15	20	n	3" Gas	[m]	168	153	151	149	146	144	142	138	135	131	126	121	115	109	102	95	78	61
E6XPD52/14A+MAC625A	18,5	25	n	3" Gas	[m]	203	184	182	179	177	175	172	168	164	159	154	148	141	134	126	118	99	79
E6XPDB52/17A+MAC630A	22	30	n	3" Gas	[m]	246	222	219	216	213	210	206	202	197	191	184	177	168	159	150	140	118	92
E6XPDB52/19A+MAC635A	26	35	m	3" Gas	[m]	278	251	248	246	244	241	238	234	229	223	216	208	200	190	180	169	144	117
E6XPDB52/22A+MAC640A	30	40	m	3" Gas	[m]	322	292	288	285	281	278	273	268	262	254	244	235	225	213	201	188	160	129
E6XPDB52/25A+MAC650B	37	50	m	3" Gas	[m]	363	328	324	320	316	311	305	299	292	283	274	263	251	238	222	208	175	140
E6XPDB52/28A+MAC650B	37	50	m	3" Gas	[m]	405	364	360	355	351	345	339	332	323	314	302	288	275	261	245	229	190	151
NPSH					[m]	-	2	2	2	2	2	2	2	2	2	2,1	2,3	2,5	2,9	3,5	5,1	7,2	

n Without conical valve

o On request

m Please contact our sales organisation

For motor performances specification see page "motor features"

n Sans soupape du clapet.

o Sur demande

m Contacter notre service commercial.

Pour caractéristiques techniques moteurs voir page "Caractéristiques des moteurs"

n Senza clapet valvola di ritegno

o Su richiesta

m Interpellare la sede o la rete di vendita

Per caratteristiche motori vedere pagina caratteristiche motori

Temperature monitoring device for submersed electric motors 4" ÷ 6": see page "Accessories"

Appareillage de contrôle de la température des moteurs électriques immergés 4" ÷ 6": voir page "Accessories"

Apparecchiatura di controllo temperatura motori elettrici sommersi 4" ÷ 6": vedere pagina accessori

Friction losses
Pertes de charge
Perdite di carico

In feet every 100 feet of straight pipeline
En mètres pour 100 mètres de tuyauterie droite
In metri ogni 100 metri di tubazione diritta

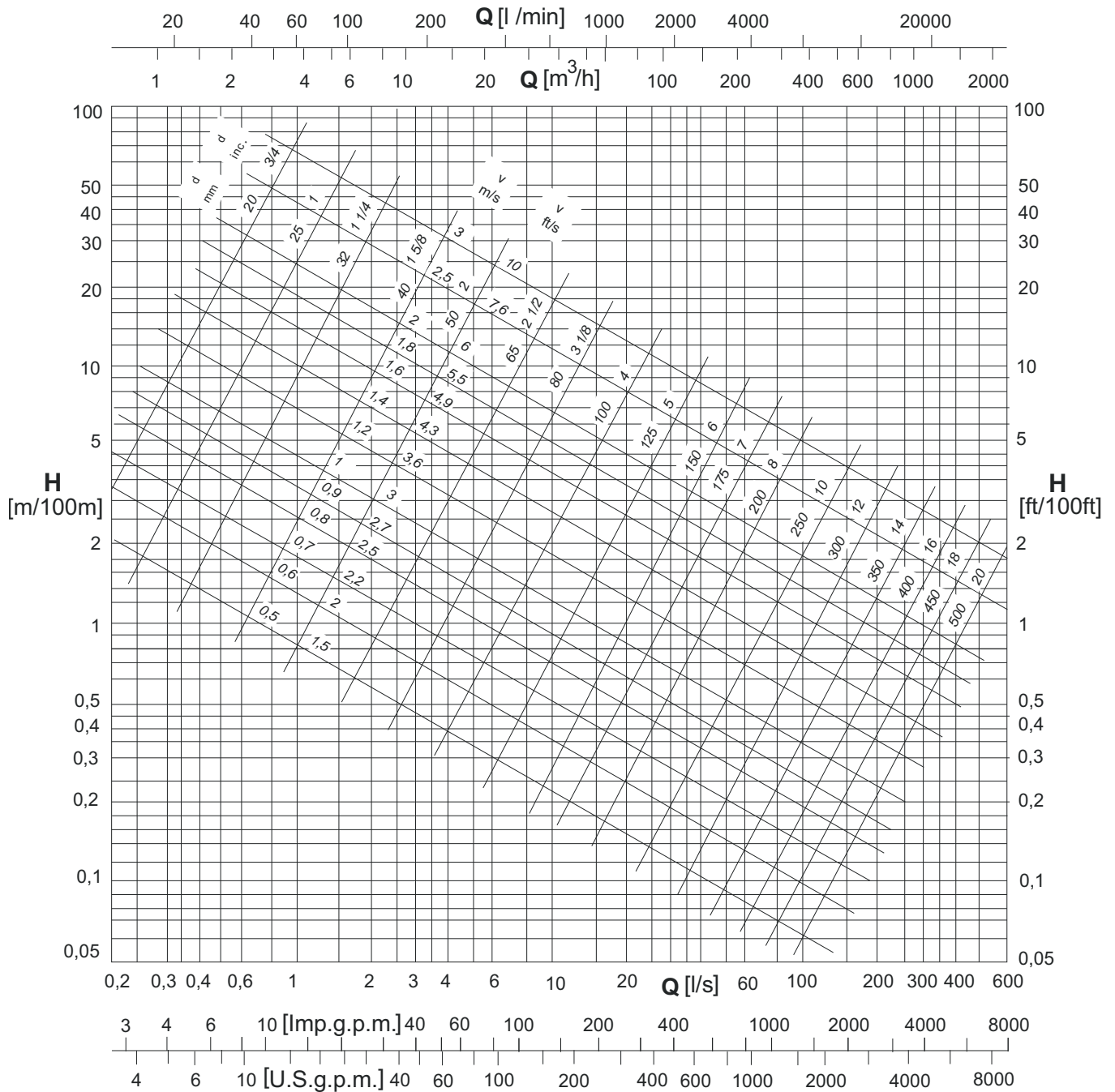

Notes: Above mentioned values are to be intended for internally smooth cast iron pipes. For an estimated evaluation, friction losses must be multiplied for:

- 0,8 for new rolled steel pipes
- 1,25 for slightly rusted steel pipes
- 0,7 for aluminium pipes
- 0,65 for PVC pipes
- 1,25 for asbestos cement pipes

Q = Capacity
v = Velocity of water
d = Diameter of pipe
h = Friction loss

Notes: Les valeurs doivent s'entendre pour tuyaux en fonte, lisses à l'intérieur. Pour une évaluation approximative, les pertes de charge doivent être multipliées par:

- 0,8 pour tuyaux laminés nouveaux en acier
- 1,25 pour tuyaux légèrement rouillés en acier
- 0,7 pour tuyaux en aluminium
- 0,65 pour tuyaux en PVC
- 1,25 pour tuyaux en fibro-ciment

Q = Débit
v = Vitesse de l'eau
d = Diamètre du tuyau
h = Perte de charge

Note: I valori sopra indicati s'intendono per tubi lisci in ghisa. Per una valutazione di massima, le perdite di carico devono essere moltiplicate per:

- 0,8 per tubi di acciaio laminati nuovi
- 1,25 per tubi di acciaio leggermente arrugginiti
- 0,7 per tubi di alluminio
- 0,65 per tubi in PVC
- 1,25 per tubi in fibro-cemento

Q = portata
v = velocità dell'acqua
d = diametro del tubo
h = perdita di carico

Single-phase motors 4" 2 Poles / 50 Hz Moteurs monophasés 4" à 2 Pôles / 50 Hz Motori monofase 4" a 2 Poli / 50 Hz																
Motor type Moteur type Motore tipo	Motor power Puiss. moteur Potenza motore		Max water temperature Temperature max eau Temperatura max acqua	Min. cooling speed Min. vitesse de refroidissement Min. velocità di raffreddamento	Starts / hour max Max démarrages / heure Max avviamenti/ora	Run capacitor (*) Capacité de marche (*) Capacità di marcia (*)	Capacity of starter (**) Capacité de démarrage (**) Capacità di avviamento (**)	Revolutions per minute Tours minute Giri al minuto	Efficiency Rendement Rendimento		Power factor Facteur de puissance Fattore di potenza		Nominal current Intensité nominale Corrente nominale		Starting Démarrage Avviamento	
	[kW]	[HP]	[°C]	[m/s]	[No.]	[µF]	[µF]	[n ⁻¹]	3/4	4/4	3/4	4/4	Fully loaded A pleine charge A pieno carico	Not loaded A vide A vuoto	Ma ----- Mn	la ----- In
						(1)		220 230 240	220 230 240	220 230 240	220 230 240	220 230 240	220 230 240	220 230 240	220 230 240	220 230 240
MC405M	0,37	0,5	30	0,08	20	20	30	2830 2840 2840	47,0 44,5 42,0	51,5 49,8 47,7	0,990 0,970 0,930	0,990 0,980 0,980	3,3 2,2 3,3	1,9 2,2 2,6	1	3,2
MC4075M	0,55	0,75	30	0,08	20	25	30	2815 2820 2820	53,5 51,0 48,5	58,7 56,8 54,4	0,985 0,955 0,920	0,990 0,980 0,980	4,3 4,3 4,3	2,3 2,8 3,5	0,87	3,28
MC41M	0,75	1	30	0,08	20	35	40	2820 2830 2830	57,0 54,5 51,0	62,1 60,0 57,5	0,975 0,940 0,895	0,980 0,970 0,970	5,6 5,6 5,6	3,1 3,9 4,8	1	3,36
MCH415M	1,1	1,5	30	0,08	20	40	40	2845 2855 2855	59,0 58,5 53,5	62,9 60,9 58,3	0,960 0,945 0,910	0,970 0,970 0,970	8,2 8,1 8,1	4,3 4,5 5,4	0,8	3,3
MCH43M	2,2	3	30	0,08	15	80	60	2815 2830 2840	63,0 61,0 60,0	68,5 68,0 66,5	0,980 0,970 0,960	0,990 0,980 0,970	14,7 14,5 14,1	6,7 8,8 9,0	0,75	3,24
MCK42M	1,5	2	30	0,08	20	60	60	2850 2860 2870	56,5 57,0 55,0	65,0 64,0 61,5	0,980 0,930 0,900	0,990 0,950 0,940	10,6 10,8 10,8	6,8 8,6 8,8	0,85	3,24
MCK43M	2,2	3	30	0,08	15	80	60	2815 2830 2840	63,0 61,0 60,0	68,5 68,0 66,5	0,980 0,970 0,960	0,990 0,980 0,970	14,7 14,5 14,1	6,7 8,8 9,0	0,75	3,24

Ma = Starting torque

Mn = Nominal couple

la = Starting current

In = Nominal current

Direction of rotation = Left (anti-clockwise) viewed from shaft projection side

(1) = Equally distributed

To supply voltages and admitted variations see the chapter: Motor general notes

(*) Run capacitor

(**) Capacity of starter capacitor with circuit breaker

Ma = Couple au démarrage

Mn = Couple nominale

la = Intensité au démarrage

In = Intensité nominale

Sens de rotation = Gauche (antihoraire) vu du côté bout d'arbre

(1) = Uniformement repartis

Pour les tensions d'alimentation et les variations admises voir le chapitre: Remarques générales moteur

(*) Capacité du condensateur de marche

(**) Capacité du condensateur de démarrage avec disjoncteur

Ma = Coppia di avviamento

Mn = Coppia nominale

la = Corrente di avviamento

In = Corrente nominale

Senso di rotazione = Sinistro (antiorario) visto lato sporgenza albero

(1) = Equamente ripartiti

Per le tensioni di alimentazione e le variazioni ammesse vedere il capitolo: Note generali motore

(*) Capacità condensatore di marcia

(**) Capacità condensatore di avviamento con disgiuntore

Three-phase motors 4" 2 Poles / 50 Hz Moteurs triphasés 4" à 2 Pôles / 50 Hz Motori trifase 4" a 2 Poli / 50 Hz														
Motor type Moteur type Motore tipo	Motor power Puiss. moteur Potenza motore		Max water temperature Température max eau Temperatura max acqua	Min. cooling speed Min. vitesse de refroidissement Min. velocità di raffreddamento	Starts / hour max Max démarrages / heure Max avviamenti/ora	Revolutions per minute Tours minute Giri al minuto	Efficiency Rendement Rendimento		Power factor Facteur de puissance Fattore di potenza		Nominal current Intensité nominale Corrente nominale		Starting Démarrage Avviamento	
							η [%]		$\cos \phi$		I_N [A]		$\frac{Ma}{Mn}$	$\frac{Ia}{In}$
	[kW]	[HP]	[°C]	[m/s]	[No.]	[n ⁻¹]	3/4	4/4	3/4	4/4	Fully loaded A pleine charge A pieno carico	Not loaded A vide A vuoto	Direct Direct Diretto	
					(1)	400	400	400	400	400	400	400	400	400
MC405	0,37	0,5	30	0,08	20	2820	53,0	58,0	0,690	0,760	1,2	0,9	2,8	4,1
MC4075	0,55	0,75	30	0,08	20	2815	61,0	64,0	0,645	0,740	1,7	1,4	3,1	4,1
MC41	0,75	1	30	0,08	20	2815	61,5	62,7	0,625	0,720	2,4	1,9	3,3	4,35
MCH415	1,1	1,5	30	0,08	20	2820	68,0	68,9	0,660	0,720	3,2	2,0	3,2	4,5
MCH42	1,5	2	30	0,08	20	2780	64,5	68,0	0,665	0,750	4,3	3,3	3	4,2
MCH43	2,2	3	30	0,08	20	2780	66,5	69,0	0,625	0,730	6,3	5,2	3	5,5
MCK42	1,5	2	30	0,08	20	2780	64,5	68,0	0,665	0,750	4,3	3,3	3	4,2
MCK43	2,2	3	30	0,08	20	2780	66,5	69,0	0,625	0,730	6,3	5,2	3	5,5
MCK44	3	4	30	0,08	20	2815	75,0	75,0	0,780	0,850	6,8	4,0	3	5,8
MCR44	3	4	30	0,08	20	2815	75,0	75,0	0,780	0,850	6,8	4,0	3	5,8
MCR455	4	5,5	30	0,08	15	2840	76,5	77,0	0,755	0,820	9,2	4,9	3,4	5,4
MCR475	5,5	7,5	30	0,08	15	2805	76,5	76,5	0,775	0,830	12,5	6,8	3	5,1
MCR410	7,5	10	30	0,08	15	2795	76,5	76,5	0,785	0,840	16,8	8,6	3,2	5,3

Ma = Starting torque

Mn = Nominal couple

Ia = Starting current

In = Nominal current

Direction of rotation = Left (anti-clockwise) viewed from shaft projection side

(1) = Equally distributed

To supply voltages and admitted variations see the chapter: Motor general notes

Ma = Couple au démarrage

Mn = Couple nominale

Ia = Intensité au démarrage

In = Intensité nominale

Sens de rotation = Gauche (antioraire) vu du côté bout d'arbre

(1) = Uniformement repartis

Pour les tensions d'alimentation et les variations admises voir le chapitre: Remarques générales moteur

Ma = Coppia di avviamento

Mn = Coppia nominale

Ia = Corrente di avviamento

In = Corrente nominale

Senso di rotazione = Sinistro (antiorario) visto lato sporgenza albero

(1) = Equamente ripartiti

Per le tensioni di alimentazione e le variazioni ammesse vedere il capitolo: Note generali motore

Three-phase motors 6" 2 Poles / 50 Hz Moteurs triphasés 6" à 2 Pôles / 50 Hz Motori trifase 6" a 2 Poli / 50 Hz																
Motor type Moteur type Motore tipo	Motor power Puiss. moteur Potenza motore		Max water temperature Température max eau Temperatura max acqua	Min. cooling speed Min. vitesse de refroidissement Min. velocità di raffreddamento	Starts / hour max Max démarrages / heure Max avviamenti/ora	Revolutions per minute Tours minute Giri al minuto	Efficiency Rendement Rendimento		Power factor Facteur de puissance Fattore di potenza		Nominal current Intensité nominale Corrente nominale		Starting Démarrage Avviamento			
	[kW]	[HP]	[°C]	[m/s]	[No.]	[n ⁻¹]	3/4	4/4	3/4	4/4	3/4	4/4	Ma	Ia		
					(1)	400	400	400	400	400	400	400	400	400	400	400

EASYWELL

MPC65/2A	4	5	30	0,2	20	2895	75,9	74,8	0,66	0,75	10,3	7,3	1,4	3,5	1,15	2,45
MPC67/2A	5,5	7	30	0,2	20	2890	78,2	77,2	0,665	0,75	13,7	9,1	2,1	4	1,35	2,8
MPC610/2A	7,5	10	30	0,2	20	2890	80,8	78,4	0,70	0,77	17,9	10,7	1,6	5,1	1,7	3,6
MPC612/2A	9,2	12	30	0,2	20	2890	80,9	80,2	0,70	0,77	21,5	12,1	1,6	4,9	1,65	3,45
MPC615/2A	11	15	30	0,2	20	2890	82	80,7	0,71	0,77	25,6	14,3	1,8	5,4	1,8	3,8
MPC617/2A	13	17	30	0,2	20	2885	79,9	79,3	0,69	0,765	30,9	19,1	1,4	4,6	1,55	3,25
MPC620/2A	15	20	30	0,2	20	2890	81	80,1	0,70	0,775	34,9	20,8	1,7	5	1,65	3,5
MPC625/2A	18,5	25	30	0,2	20	2885	83,5	81,9	0,67	0,75	43,5	27,8	1,6	4,7	1,55	3,3
MPC630/2A	22	30	30	0,2	20	2880	82,5	81,9	0,695	0,77	50,3	30,4	2	5	1,65	3,5
MPC635/2A	26	35	30	0,2	20	2880	84,6	83,4	0,685	0,76	59,2	35,9	1,7	4,8	1,6	3,35
MPC640/2A	30	40	30	0,2	20	2885	85,2	83,3	0,655	0,745	69,7	44,9	2,2	5,7	1,9	4
MPC650/2A	37	50	30	0,2	20	2875	83,4	82,4	0,675	0,76	85,2	53,7	2,7	6	2	4,2

MAC65/3A	4	5,5	40	0,5	20	2910	77,5	78,5	0,706	0,77	9,5	5,4	1	4,35	1,45	3,05
MAC67/3A	5,5	7,5	40	0,5	20	2890	79,6	79	0,772	0,815	12,3	5,9	0,9	4	1,35	2,80
MAC610/3A	7,5	10	40	0,5	20	2905	79,2	80,5	0,768	0,81	16,6	7,7	1	4,45	1,50	3,10
MAC612/3A	9,2	12,5	40	0,5	20	2900	78,3	81	0,724	0,79	20,7	10,4	0,9	4,2	1,40	2,95
MAC615/3A	11	15	40	0,5	20	2890	80,7	81,5	0,691	0,77	25,3	14,2	1,4	4,75	1,60	3,30
MAC617/3A	13	17,5	40	0,5	20	2890	81,6	82	0,701	0,78	29,3	15,5	1,3	4,75	1,60	3,30
MAC620/3A	15	20	40	0,5	20	2890	83,3	82,5	0,738	0,8	32,6	15,8	1	4,2	1,40	2,95
MAC625/3A	18,5	25	35	0,5	20	2875	83,7	83	0,746	0,8	40,2	21,1	1,5	4,8	1,60	3,35
MAC630/3A	22	30	35	0,5	20	2870	84,2	83	0,751	0,82	46,6	23,2	1,5	4,9	1,65	3,45
MAC635/3A	26	35	35	0,5	20	2880	85,4	84	0,725	0,8	55,8	29,9	1,7	5,25	1,75	3,65
MAC640/3A	30	40	35	0,5	20	2870	85,4	83,5	0,77	0,83	62,5	28,7	1,3	4,6	1,55	3,20
MAC650/3A	37	50	30	0,5	20	2860	85,2	83,5	0,776	0,835	76,6	34,9	1,3	4,55	1,50	3,20

MAC65/3B	4	5,5	45	0,5	20	2910	79,7	80	0,701	0,78	9,2	5	1	4,4	1,45	3,10
MAC67/3B	5,5	7,5	45	0,5	20	2910	80,9	81	0,756	0,815	12	5,6	0,9	4,15	1,40	2,90
MAC610/3B	7,5	10	45	0,5	20	2905	82,6	81,5	0,772	0,82	16,2	6,7	1	3,4	1,15	2,40
MAC612/3B	9,2	12,5	45	0,5	20	2900	83,9	82,5	0,787	0,83	19,4	7,4	1	3,4	1,15	2,40
MAC615/3B	11	15	45	0,5	20	2900	84,4	83	0,76	0,82	23,3	9,9	1,4	3,8	1,25	2,65
MAC617/3B	13	17,5	45	0,5	20	2900	84,2	84	0,735	0,805	27,7	13,7	1,3	4,75	1,60	3,30
MAC620/3B	15	20	45	0,5	20	2900	84,8	84	0,761	0,82	31,4	14,4	1,5	4,4	1,45	3,10
MAC625/3B	18,5	25	40	0,5	20	2880	84,4	84	0,743	0,8	39,8	19,5	1,5	4,2	1,40	2,95
MAC630/3B	22	30	40	0,5	20	2895	84,9	84,5	0,703	0,78	48	27	1,7	5,5	1,85	3,85
MAC635/3B	26	35	40	0,5	20	2880	85,7	85	0,759	0,815	54,2	25,1	1,7	4,4	1,45	3,10
MAC640/3B	30	40	40	0,5	20	2885	85,7	85	0,745	0,81	63	30,8	1,3	4,75	1,60	3,30
MAC650/3B	37	50	35	0,5	20	2875	85,5	84,5	0,734	0,805	78,5	40,7	1,6	5,1	1,70	3,55
MAC660/3B	45	60	35	0,5	15	2855	84,3	82,5	0,749	0,815	96,3	48,8	1,5	4,65	1,55	3,25

Ma = Starting torque
Mn = Nominal couple
Ia = Starting current
In = Nominal current

Direction of rotation = Left (anti-clockwise) viewed from shaft projection side

(1) = Equally distributed

To supply voltages and admitted variations see the chapter: Motor general notes

Ma = Couple au démarrage

Mn = Couple nominale

Ia = Intensité au démarrage

In = Intensité nominale

Sens de rotation = Gauche (antihoraire) vu du côté bout d'arbre

(1) = Uniformement repartis

Pour les tensions d'alimentation et les variations admises voir le chapitre: Remarques générales moteur

Ma = Coppia di avviamento

Mn = Coppia nominale

Ia = Corrente di avviamento

In = Corrente nominale

Senso di rotazione = Sinistro (antiorario) visto lato sporgenza albero

(1) = Equamente ripartiti

Per le tensioni di alimentazione e le variazioni ammesse vedere il capitolo: Note generali motore

Single-phase and three-phase motors 2 Pole / 50 Hz - Overall dimensions and weights
 Moteurs monophasés et triphasés 2 Pôles / 50 Hz - Dimensions d'encombrement et poids
 Motori monofase e trifase a 2 Poli / 50 Hz - Dimensioni di ingombro e pesi

	Motor type Moteur type Motore tipo	Coupling flange Bride d'accouplement Flangia accoppiamento	Motor weight Poids moteur Peso motore	L	Ø E	S	Axial load Charge axiale Carico assiale	Length A Longueur A Lunghezza A	Cables outlet Sortie des câbles Uscita cavi	
									Cross section [mm ²] Section en [mm ²] Sezione in [mm ²]	
									Starting Démarrage Avviamento	
									Direct Direct Diretto	
			[kg]	[mm]			[N]	[m]	220 - 230	230 - 240
	MC405M	NEMA 4"	7	345	96	38	1500	1,5	1 x (4x1,5) (C.C.:1)	1 x (4x1,5) (C.C.:2)
	MC4075M	NEMA 4"	7,6	345	96	38	1500	1,5	1 x (4x1,5) (C.C.:1)	1 x (4x1,5) (C.C.:2)
	MC41M	NEMA 4"	8,7	370	96	38	1500	1,5	1 x (4x1,5) (C.C.:1)	1 x (4x1,5) (C.C.:2)
	MCH415M	NEMA 4"	10,3	405	96	38	2500	1,5	1 x (4x1,5) (C.C.:1)	1 x (4x1,5) (C.C.:2)
	MCH43M	NEMA 4"	15,1	505	96	38	2500	1,5	1 x (4x1,5) (C.C.:1)	1 x (4x1,5) (C.C.:2)
	MCK42M	NEMA 4"	11,7	436	96	38	4000	1,5	1 x (4x1,5) (C.C.:1)	1 x (4x1,5) (C.C.:2)
	MCK43M	NEMA 4"	15,1	505	96	38	4000	1,5	1 x (4x1,5) (C.C.:1)	1 x (4x1,5) (C.C.:2)
Section Section Sezione		F								
[mm ²]		[mm]								
		4 x 1,5			5,6					
		4 x 2			6					

C.C = Motor manufacturing code

C.C = Code construction moteur

C.C = Codice costruttivo motore

Single-phase and three-phase motors 2 Pole / 50 Hz - Overall dimensions and weights
 Moteurs monophasés et triphasés 2 Pôles / 50 Hz - Dimensions d'encombrement et poids
 Motori monofase e trifase a 2 Poli / 50 Hz - Dimensioni di ingombro e pesi

	Motor type <i>Moteur type</i> Motore tipo	Coupling flange <i>Bride d'accouplement</i> Flangia accoppiamento	Motor weight <i>Poids moteur</i> Peso motore	L	Ø E	S	Axial load <i>Charge axiale</i> Carico assiale	Cables outlet <i>Sortie des câbles</i> Uscita cavi		
								Length A <i>Longueur A</i> Lunghezza A	Cross section [mm ²] <i>Section en [mm²]</i> Sezione in [mm²]	
									Starting <i>Démarrage</i> Avviamento	
									Direct <i>Direct</i> Diretto	
[kg]	[mm]	[N]	[m]	230	400					
MC405	NEMA 4"	6,5	345	96	38	1500	1,5	1 x (4x1,5) (C.C.:6)	1 x (4x1,5) (C.C.:8)	
MC4075	NEMA 4"	7	345	96	38	1500	1,5	1 x (4x1,5) (C.C.:6)	1 x (4x1,5) (C.C.:8)	
MC41	NEMA 4"	7,6	345	96	38	1500	1,5	1 x (4x1,5) (C.C.:6)	1 x (4x1,5) (C.C.:8)	
MCH415	NEMA 4"	8,7	370	96	38	2500	1,5	1 x (4x1,5) (C.C.:6)	1 x (4x1,5) (C.C.:8)	
MCH42	NEMA 4"	10,2	386	96	38	2500	1,5	1 x (4x1,5) (C.C.:6)	1 x (4x1,5) (C.C.:8)	
MCH43	NEMA 4"	11,9	450	96	38	2500	1,5	1 x (4x1,5) (C.C.:6)	1 x (4x1,5) (C.C.:8)	
MCK42	NEMA 4"	10,2	386	96	38	4000	1,5	1 x (4x1,5) (C.C.:6)	1 x (4x1,5) (C.C.:8)	
MCK43	NEMA 4"	11,9	450	96	38	4000	1,5	1 x (4x1,5) (C.C.:6)	1 x (4x1,5) (C.C.:8)	
MCK44	NEMA 4"	14,9	450	96	38	4000	1,5	1 x (4x1,5) (C.C.:6)	1 x (4x1,5) (C.C.:8)	
**MCR44	NEMA 4"	14,9	450	96	38	5000	1,5	1 x (4x1,5) (C.C.:6)	1 x (4x1,5) (C.C.:8)	
**MCR455	NEMA 4"	15,1	505	96	38	5000	2,5	1 x (4x2) (C.C.:6)	1 x (4x2) (C.C.:8)	
**MCR475	NEMA 4"	24,7	700	96	38	5000	2,5	1 x (4x2) (C.C.:6)	1 x (4x2) (C.C.:8)	
**MCR410	NEMA 4"	29	800	96	38	5000	2,5	1 x (4x2) (C.C.:6)	1 x (4x2) (C.C.:8)	

Section <i>Section</i> Sezione	F	
[mm ²]	[mm]	
4 x 1,5	5,6	
4 x 2	6	

C.C = Motor manufacturing code
 ** With plugging cable

C.C = Code construction moteur
 ** Avec cable à connecteur extractible

C.C = Codice costruttivo motore
 ** Con cavo a connettore estraibile

Single-phase and three-phase motors 2 Pole / 50 Hz - Overall dimensions and weights
 Moteurs monophasés et triphasés 2 Pôles / 50 Hz - Dimensions d'encombrement et poids
 Motori monofase e trifase a 2 Poli / 50 Hz - Dimensioni di ingombro e pesi

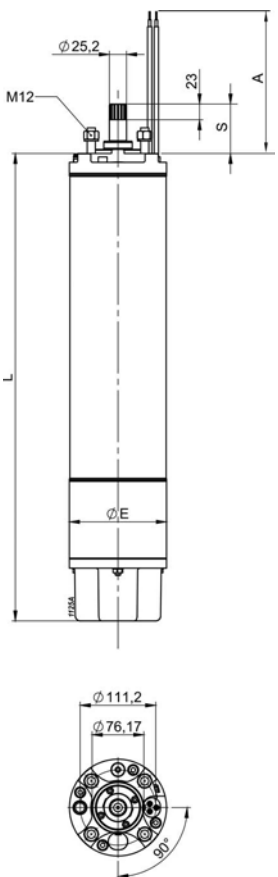
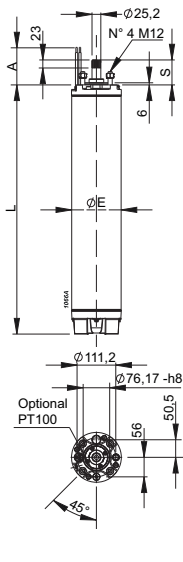
	Motor type Moteur type Motore tipo	Coupling flange Bride d'accouplement Flangia accoppiamento	Motor weight Poids moteur Peso motore	L	Ø E	S	Axial load Charge axiale Carico assiale	Cables outlet Sortie des câbles Uscita cavi																	
								Length A Longueur A Lunghezza A	Cross section [mm ²] Section en [mm ²] Sezione in [mm ²]						Starting Démarrage Avviamento										
									Direct Directo				Star-delta Etoile-triangle Stella-triangolo												
									230	230 - 400	400	400 - 700	230 / 400	400 / 700											
													EASYWELL												
MPC65/2A	NEMA 6"	42	690	143	73	28000	3,5	-	-	3x(1x2,5) (C.C.:8)	6x(1x2,5) (C.C.:9)	-	6x(1x2,5) (C.C.:9)												
MPC67/2A	NEMA 6"	46,2	735	143	73	28000	3,5	-	-	3x(1x2,5) (C.C.:8)	6x(1x2,5) (C.C.:9)	-	6x(1x2,5) (C.C.:9)												
MPC610/2A	NEMA 6"	51,2	780	143	73	28000	3,5	-	-	3x(1x2,5) (C.C.:8)	6x(1x2,5) (C.C.:9)	-	6x(1x2,5) (C.C.:9)												
MPC612/2A	NEMA 6"	54,6	810	143	73	28000	3,5	-	-	3x(1x2,5) (C.C.:8)	6x(1x2,5) (C.C.:9)	-	6x(1x2,5) (C.C.:9)												
MPC615/2A	NEMA 6"	56,8	840	143	73	28000	3,5	-	-	3x(1x2,5) (C.C.:8)	6x(1x2,5) (C.C.:9)	-	6x(1x2,5) (C.C.:9)												
MPC617/2A	NEMA 6"	63	890	143	73	28000	3,5	-	-	3x(1x2,5) (C.C.:8)	6x(1x2,5) (C.C.:9)	-	6x(1x2,5) (C.C.:9)												
MPC620/2A	NEMA 6"	67,2	930	143	73	28000	3,5	-	-	3x(1x2,5) (C.C.:8)	6x(1x2,5) (C.C.:9)	-	6x(1x2,5) (C.C.:9)												
MPC625/2A	NEMA 6"	76	1015	143	73	28000	3,5	-	-	3x(1x4) (C.C.:8)	6x(1x2,5) (C.C.:9)	-	6x(1x2,5) (C.C.:9)												
MPC630/2A	NEMA 6"	80,9	1060	143	73	28000	3,5	-	-	3x(1x6) (C.C.:8)	6x(1x2,5) (C.C.:9)	-	6x(1x2,5) (C.C.:9)												
MPC635/2A	NEMA 6"	91,6	1165	143	73	28000	3,5	-	-	3x(1x6) (C.C.:8)	6x(1x4) (C.C.:9)	-	6x(1x4) (C.C.:9)												
MPC640/2A	NEMA 6"	103	1275	143	73	28000	4,5	-	-	3x(1x10) (C.C.:8)	6x(1x4) (C.C.:9)	-	6x(1x4) (C.C.:9)												
MPC650/2A	NEMA 6"	113	1365	143	73	28000	4,5	-	-	3x(1x10) (C.C.:8)	6x(1x6) (C.C.:9)	-	6x(1x6) (C.C.:9)												
													HT HI - TECH												
MAC65/3A	NEMA 6"	34,6	570	143	73	30000	3,5	3x(1x4) (C.C.:6)	6x(1x2,5) (C.C.:7)	3x(1x2,5) (C.C.:8)	6x(1x2,5) (C.C.:9)	6x(1x2,5) (C.C.:7)	6x(1x2,5) (C.C.:9)												
MAC67/3A	NEMA 6"	39,6	615	143	73	30000	3,5	3x(1x4) (C.C.:6)	6x(1x2,5) (C.C.:7)	3x(1x2,5) (C.C.:8)	6x(1x2,5) (C.C.:9)	6x(1x2,5) (C.C.:7)	6x(1x2,5) (C.C.:9)												
MAC610/3A	NEMA 6"	44,4	670	143	73	30000	3,5	3x(1x4) (C.C.:6)	6x(1x2,5) (C.C.:7)	3x(1x2,5) (C.C.:8)	6x(1x2,5) (C.C.:9)	6x(1x2,5) (C.C.:7)	6x(1x2,5) (C.C.:9)												
MAC612/3A	NEMA 6"	47,7	700	143	73	30000	3,5	3x(1x4) (C.C.:6)	6x(1x2,5) (C.C.:7)	3x(1x2,5) (C.C.:8)	6x(1x2,5) (C.C.:9)	6x(1x2,5) (C.C.:7)	6x(1x2,5) (C.C.:9)												
MAC615/3A	NEMA 6"	52	715	143	73	30000	3,5	3x(1x4) (C.C.:6)	6x(1x2,5) (C.C.:7)	3x(1x2,5) (C.C.:8)	6x(1x2,5) (C.C.:9)	6x(1x2,5) (C.C.:7)	6x(1x2,5) (C.C.:9)												
MAC617/3A	NEMA 6"	56	750	143	73	30000	3,5	3x(1x6) (C.C.:6)	6x(1x4) (C.C.:7)	3x(1x4) (C.C.:8)	6x(1x4) (C.C.:9)	6x(1x4) (C.C.:7)	6x(1x4) (C.C.:9)												
MAC620/3A	NEMA 6"	59,8	790	143	73	30000	3,5	3x(1x6) (C.C.:6)	6x(1x4) (C.C.:7)	3x(1x4) (C.C.:8)	6x(1x4) (C.C.:9)	6x(1x4) (C.C.:7)	6x(1x4) (C.C.:9)												
MAC625/3A	NEMA 6"	64,2	830	143	73	30000	3,5	3x(1x6) (C.C.:6)	6x(1x4) (C.C.:7)	3x(1x4) (C.C.:8)	6x(1x4) (C.C.:9)	6x(1x4) (C.C.:7)	6x(1x4) (C.C.:9)												
MAC630/3A	NEMA 6"	74,5	920	143	73	30000	3,5	3x(1x10) (C.C.:6)	6x(1x4) (C.C.:7)	3x(1x4) (C.C.:8)	6x(1x4) (C.C.:9)	6x(1x4) (C.C.:7)	6x(1x4) (C.C.:9)												
MAC635/3A	NEMA 6"	89,3	1055	143	73	30000	3,5	3x(1x10) (C.C.:6)	6x(1x6) (C.C.:7)	3x(1x6) (C.C.:8)	6x(1x4) (C.C.:9)	6x(1x6) (C.C.:7)	6x(1x4) (C.C.:9)												
MAC640/3A	NEMA 6"	101,9	1165	143	73	30000	3,5	3x(1x10) (C.C.:6)	6x(1x6) (C.C.:7)	3x(1x6) (C.C.:8)	6x(1x4) (C.C.:9)	6x(1x6) (C.C.:7)	6x(1x4) (C.C.:9)												
MAC650/3A	NEMA 6"	111	1245	143	73	30000	4,5	-	6x(1x6) (C.C.:7)	3x(1x10) (C.C.:8)	6x(1x6) (C.C.:9)	6x(1x6) (C.C.:7)	6x(1x6) (C.C.:9)												

Overall dimensions and weights
Dimensions d'encombement et poids
Dimensioni di ingombro e pesi

Motor type Moteur type Motore tipo	Coupling flange Bride d'accouplement Flangia accoppiamento	Motor weight Poids moteur Peso motore	L	Ø E	S	Axial load Charge axiale Carico assiale	Length A Longueur A Lunghezza A	Cables outlet Sortie des câbles Uscita cavi					
								Cross section [mm ²] Section en [mm ²] Sezione in [mm ²]					
								Starting Démarrage Avviamento					
								Direct Direct Diretto			Star-delta Etoile-triangle Stella-triangolo		
[kg]	[mm]	[N]	[m]	230	230 - 400	400	400 - 700	230 / 400	400 / 700				
MAC65/3B	NEMA 6"	45,6	597	143	73	45000	3,5	3x(1x4) (C.C.:6)	6x(1x2,5) (C.C.:7)	3x(1x2,5) (C.C.:8)	6x(1x2,5) (C.C.:9)	6x(1x2,5) (C.C.:7)	6x(1x2,5) (C.C.:9)
MAC67/3B	NEMA 6"	51	642	143	73	45000	3,5	3x(1x4) (C.C.:6)	6x(1x2,5) (C.C.:7)	3x(1x2,5) (C.C.:8)	6x(1x2,5) (C.C.:9)	6x(1x2,5) (C.C.:7)	6x(1x2,5) (C.C.:9)
MAC610/3B	NEMA 6"	56,8	702	143	73	45000	3,5	3x(1x4) (C.C.:6)	6x(1x2,5) (C.C.:7)	3x(1x2,5) (C.C.:8)	6x(1x2,5) (C.C.:9)	6x(1x2,5) (C.C.:7)	6x(1x2,5) (C.C.:9)
MAC612/3B	NEMA 6"	61	752	143	73	45000	3,5	3x(1x4) (C.C.:6)	6x(1x2,5) (C.C.:7)	3x(1x2,5) (C.C.:8)	6x(1x2,5) (C.C.:9)	6x(1x2,5) (C.C.:7)	6x(1x2,5) (C.C.:9)
MAC615/3B	NEMA 6"	66	792	143	73	45000	3,5	3x(1x4) (C.C.:6)	6x(1x2,5) (C.C.:7)	3x(1x2,5) (C.C.:8)	6x(1x2,5) (C.C.:9)	6x(1x2,5) (C.C.:7)	6x(1x2,5) (C.C.:9)
MAC617/3B	NEMA 6"	70,7	832	143	73	45000	3,5	3x(1x6) (C.C.:6)	6x(1x4) (C.C.:7)	3x(1x4) (C.C.:8)	6x(1x4) (C.C.:9)	6x(1x4) (C.C.:7)	6x(1x4) (C.C.:9)
MAC620/3B	NEMA 6"	75,4	877	143	73	45000	3,5	3x(1x6) (C.C.:6)	6x(1x4) (C.C.:7)	3x(1x4) (C.C.:8)	6x(1x4) (C.C.:9)	6x(1x4) (C.C.:7)	6x(1x4) (C.C.:9)
MAC625/3B	NEMA 6"	80,4	922	143	73	45000	3,5	3x(1x6) (C.C.:6)	6x(1x4) (C.C.:7)	3x(1x4) (C.C.:8)	6x(1x4) (C.C.:9)	6x(1x4) (C.C.:7)	6x(1x4) (C.C.:9)
MAC630/3B	NEMA 6"	92,5	1022	143	73	45000	3,5	3x(1x10) (C.C.:6)	6x(1x4) (C.C.:7)	3x(1x4) (C.C.:8)	6x(1x4) (C.C.:9)	6x(1x4) (C.C.:7)	6x(1x4) (C.C.:9)
MAC635/3B	NEMA 6"	104	1132	143	73	45000	3,5	3x(1x10) (C.C.:6)	6x(1x6) (C.C.:7)	3x(1x6) (C.C.:8)	6x(1x4) (C.C.:9)	6x(1x6) (C.C.:7)	6x(1x4) (C.C.:9)
MAC640/3B	NEMA 6"	111	1222	143	73	45000	3,5	3x(1x10) (C.C.:6)	6x(1x6) (C.C.:7)	3x(1x6) (C.C.:8)	6x(1x4) (C.C.:9)	6x(1x6) (C.C.:7)	6x(1x4) (C.C.:9)
MAC650/3B	NEMA 6"	119	1282	143	73	45000	4,5	-	6x(1x6) (C.C.:7)	3x(1x10) (C.C.:8)	6x(1x6) (C.C.:9)	6x(1x6) (C.C.:7)	6x(1x6) (C.C.:9)
MAC660/3B	NEMA 6"	123,3	1322	143	73	45000	4,5	-	6x(1x10) (C.C.:7)	3x(1x10) (C.C.:8)	6x(1x6) (C.C.:9)	6x(1x10) (C.C.:7)	6x(1x6) (C.C.:9)

Section Section Sezione	F
[mm ²]	[mm]
1 x 2,5	6,2
1 x 2,5	6,4
1 x 4	7,0
1 x 4	7,1
1 x 6	7,7
1 x 6	7,9
1 x 10	9,1
1 x 10	9,2
1 x 16	10,25
1 x 16	10,6
1 x 25	11,6
1 x 25	12,5
1 x 35	12,5
1 x 35	13,7
1 x 50	14,45
1 x 50	16,4
1 x 70	16,35
1 x 70	18,6
1 x 95	21,7

C.C = Motor manufacturing code

C.C = Code construction moteur

C.C = Codice costruttivo motore

Dynamic momentum of the wet end
Moment dynamique partie hydraulique
Momento dinamico parte idraulica

Standard construction <i>Exécution standard</i> Esecuzione standard		
Electric pump type <i>Electropompe type</i> Elettropompa tipo	J Wet <i>J Mouillé</i> J Bagnato	
	Single stage <i>Mono étage</i> Monostadio	For each additional stage <i>Pour chaque étage en plus</i> Per ogni stadio in più
	J=1/4 PD ²	
	[kgm²]	
E6XD20 (x 4")	0,000143	0,000026
E6XD20 (x 6")	0,000190	0,000026
E6XD25 (x 4")	0,000156	0,000026
E6XD25 (x 6")	0,000206	0,000026
E6XD30 (x 4")	0,000182	0,000052
E6XD30 (x 6")	0,000247	0,000052
E6XD35 (x 4")	0,000195	0,000065
E6XD35 (x 6")	0,000260	0,000065
E6XD40 (x 4")	0,000195	0,000065
E6XD40 (x 6")	0,000260	0,000065
E6XD50 (x 4")	0,000208	0,000078
E6XD50 (x 6")	0,000273	0,000078
E6XPD52 (x 4")	0,000208	0,000078
E6XPD52 (x 6")	0,000273	0,000078

Dynamic momentum of the motor
Moment dynamique moteur
Momento dinamico motore

Dynamic momentum of the motor Moment dynamique moteur Momento dinamico motore	
Motor type Moteur type Motore tipo	$J=1/4 PD^2$ [kgm ²]
EASYWELL	
MPC65/2A	0,0029
MPC67/2A	0,0043
MPC610/2A	0,0052
MPC612/2A	0,0057
MPC615/2A	0,0063
MPC617/2A	0,0072
MPC620/2A	0,0079
MPC625/2A	0,0093
MPC630/2A	0,0101
MPC635/2A	0,0120
MPC640/2A	0,0139
MPC650/2A	0,0155
HT HI - TECH	
MAC65/3A	0,0029
MAC67/3A	0,0040
MAC610/3A	0,0054
MAC612/3A	0,0065
MAC615/3A	0,0068
MAC617/3A	0,0077
MAC620/3A	0,0086
MAC625/3A	0,0096
MAC630/3A	0,0120
MAC635/3A	0,0150
MAC640/3A	0,0180
MAC650/3A	0,0200

Dynamic momentum of the motor Moment dynamique moteur Momento dinamico motore	
Motor type Moteur type Motore tipo	$J=1/4 PD^2$ [kgm ²]
HT desert HI - TECH	
MAC65/3B	0,0042
MAC67/3B	0,0053
MAC610/3B	0,0065
MAC612/3B	0,0077
MAC615/3B	0,0086
MAC617/3B	0,0096
MAC620/3B	0,0110
MAC625/3B	0,0120
MAC630/3B	0,0141
MAC635/3B	0,0163
MAC640/3B	0,0183
MAC650/3B	0,0195
MAC660/3B	0,0202

The choice of the feeding cable is made considering:

1. acceptable voltage drop
2. power loss in the cable
3. maximum current admitted by the cable.

Le choix du câble d'alimentation s'effectue sur la base:

1. de la chute de tension admissible
2. de la perte de puissance dans la longueur considérée
3. de l'intensité maximale admissible dans le câble.

La scelta del cavo di alimentazione si effettua sulla base:

1. della caduta di tensione ammissibile
2. della potenza dissipata lungo il cavo
3. della corrente massima ammissibile nel cavo.

1.1. Voltage drop ΔU [%] in three-wire cables (resistance only)
Chute de tension ΔU [%] pour câbles tripolaires (résistance seulement)
Caduta di tensione ΔU [%] per cavi tripolari (sola resistenza)

1.1.1. 3-phase motor with - *Moteur triphasé avec* - **Motore trifase con** :
Starting: direct, by statoric impedences, by autotransformer
Démarrage: direct, à impédances statoriques, avec auto-trasformateur
Avviamento: diretto, a impedenze statoriche, con autotrasformatore

1 three-wire cable 3 x s
1 câble trois fils 3 x s
1 cavo tripolare 3 x s

$$\Delta U = \frac{I \cdot L \cdot \cos \varphi}{s \cdot 32,3} \times \frac{100}{U} : s = \frac{I \cdot L \cdot \cos \varphi}{\Delta U \cdot 32,3} \times \frac{100}{U}$$

1.1.2. 3-phase motor with - *Moteur triphasé avec* - **Motore trifase con**:
Starting: star-delta
Démarrage: étoile-triangle
Avviamento: stella-triangolo

2 three-wire cable 3 x s
2 câbles trois fils 3 x s
2 cavi tripolari 3 x s

$$\Delta U = \frac{I \cdot L \cdot \cos \varphi}{s \cdot 48,5} \times \frac{100}{U} : s = \frac{I \cdot L \cdot \cos \varphi}{\Delta U \cdot 48,5} \times \frac{100}{U}$$

1.1.3. Single-phase motor
Moteur monophasé
Motore monofase

1 three-wire cable 3 x s
1 câble trois fils 3 x s
1 cavo tripolare 3 x s

$$\Delta U = \frac{I \cdot L \cdot \cos \varphi}{s \cdot 28} \times \frac{100}{U} : s = \frac{I \cdot L \cdot \cos \varphi}{\Delta U \cdot 28} \times \frac{100}{U}$$

1.2. Voltage drop ΔU [%] in single-wire cables (resistance and reactance)
Chute de tension ΔU [%] pour câbles unipolaires (résistance et réactance)
Caduta di tensione ΔU [%] per cavi unipolari (resistenza e reattanza)

$$\Delta U = 1,73 \cdot I \cdot L \cdot (R \cdot \cos \varphi + X \cdot \sin \varphi) \cdot \frac{100}{U}$$

1.2.1. The voltage drop changes according to the resistance and the reactance induced by single-wires each other according to:
- the cables cross section
- their respective position (single, paired, side by side)
- their angular position (at 120° at 180°)

La chute de tension varie en fonction de la résistance et de la réactance d'induction causée par les conducteurs entre eux et en fonction de:

- la section des câbles
- la position entre eux (single, jumelés côte à côte)
- leur position angulaire (à 120° à 180°)

La caduta di tensione varia in funzione della resistenza e della reattanza induttiva esercitata reciprocamente dai singoli conduttori in funzione:

- della dimensione dei cavi
- della loro posizione reciproca (singoli, abbinati, affiancati)
- della loro disposizione angolare (a 120° a 180°)

1.3. For different supply voltages:
Pour tensions d'alimentation différentes: $L_N = L \cdot \frac{U_N}{230} : L_N = L \cdot \frac{U_N}{400}$
Per tensioni di alimentazione diverse:

1.4. For different power factors: $L_N = L \cdot \frac{0,8}{\cos \varphi}$
Pour $\cos \varphi$ différents:
Per $\cos \varphi$ diversi:

2.1. Power loss P_v along the feeding cables
Perte de puissance P_v le long des câbles d'alimentation
Perdita di potenza P_v lungo i cavi di alimentazione

$$P_v = I^2 \cdot \frac{L}{s \cdot 18,7} [W]$$

I = Motor nominal current [A]
= *Intensité nominale du moteur [A]*
= **Assorbimento nominale del motore [A]**

R = Cable resistance [Ω/m]
= *Résistance et du câble [Ω/m]*
= **Resistenza del cavo [Ω/m]**

U_N = New voltage [V]
= *Nouvelle tension [V]*
= **Nuova tensione [V]**

L = Cable length [m]
= *Longueur du câble [m]*
= **Lunghezza del cavo [m]**

X = Inductive reactance [Ω/m]
= *Réactance d'induction [Ω/m]*
= **Reattanza induttiva [Ω/m]**

ΔU = Voltage drop [%]
= *Chute de tension [%]*
= **Caduta di tensione [%]**

L_N = New cable length [m]
= *Nouvelle longueur du câble [m]*
= **Nuova lunghezza cavo [m]**

U = Nominal voltage [V]
= *Tension nominale [V]*
= **Tensione nominale [V]**

s = Copper wire cross-section [mm²]
= *Section du conducteur en cuivre [mm²]*
= **Sezione del conduttore in rame [mm²]**

Cos φ = Full-load power factor (see table motors operating data)
= *Facteur de puissance à pleine charge (voir tableau caractéristiques moteurs)*
= **Fattore di potenza a pieno carico (vedi tabella caratteristiche motori)**

Maximum permitted current
 Courant maximum admissible
 Corrente massima ammissibile

Tree-wire cables EPR/PVC* 4" insulated Câbles tripolaires isolés en EPR/PVC* 4" Cavi tripolari isolati in EPR/PVC* 4"							
Cable cross-section 3 x s Section du câble 3 x s Sezione del cavo 3 x s	[mm ²]	1,5	2,5	4	6	10	16
Imax allowable I _{max} admissible I _{max} ammissibile	[A]	15	21	28	36	50	67
Max. operating temperature Température maximum de service Temperatura max di esercizio	[°C]	60	60	60	60	60	60

For different environmental temperatures apply the multiplication coefficient K:
 Pour des températures ambiantes différentes appliquer le coefficient multiplicatif K:
 Per temperature diverse applicare il coefficiente moltiplicativo K:

Ambient temperature Température ambiante Temperatura ambiente	[°C]	10	15	20	25	30	35	40	45	50
In the open air A l'air libre In aria libera	K	1,21	1,16	1,1	1,05	1	0,94	0,88	0,83	0,77

The maximum allowable current values refer to cables installed in free air at 30°C ambient temperature. If the installation conditions are different, multiply the allowable maximum current value in the table by coefficient:

0,83 (EPR) - 0,78 (PVC) if the cables are ducted in air;
 0,7 (EPR) - 0,76 (PVC) if the cables are buried in the ground (soil temperature 20°C)

* Cables in EPR are certified for contact with drinking water in accordance with the following regulations: WRAS (Water Regulations Advisory Scheme) according to BS 6920; ACS (Attestation de Conformité Sanitaire) according to DGS/VS4 99/217 and DGS/VS4 2000/232; Ministerial Decree D.M. 174/04.

Les caractéristiques de l'intensité maximale admissible se réfèrent à des câbles posés à l'air libre à une température ambiante de 30°C. En cas de conditions de pose différentes, multiplier l'intensité maximale admissible du tableau par le coefficient:

0,83 (EPR) - 0,78 (PVC) en cas de pose sous tube à l'air libre;
 0,7 (EPR) - 0,76 (PVC) en cas de pose enterrée (température du sol 20°C)

* Les câbles en EPR sont certifiés au contact direct avec l'eau potable, conformément aux normes : WRAS (Water Regulations Advisory Scheme) suivant la BS 6920; ACS (Attestation de Conformité Sanitaire) suivant les circulaires DGS/VS4 99/217 et DGS/VS4 2000/232; D.M. 174/04.

I dati di corrente massima ammissibile sono riferiti ad una posa dei cavi in aria libera a temperatura ambiente di 30°C. Per condizioni di posa differenti, moltiplicare la corrente massima ammissibile di tabella per il coefficiente:

0,83 (EPR) - 0,78 (PVC) in caso di posa in tubo in aria;
 0,7 (EPR) - 0,76 (PVC) in caso di posa interrata (temperatura terreno 20°C)

* I cavi in EPR sono certificati al contatto con l'acqua potabile, ai sensi delle normative: WRAS (Water Regulations Advisory Scheme) secondo la BS 6920; ACS (Attestation de Conformité Sanitaire) secondo le DGS/VS4 99/217 e DGS/VS4 2000/232; D.M. 174/04.

Maximum permitted current
 Courant maximum admissible
 Corrente massima ammissibile

Tree-wire cables EPDM/EPR* 6" insulated Câbles tripolaires isolés en EPDM/EPR* 6" Cavi tripolari isolati in EPDM/EPR* 6"															
Cable cross-section 3 x s Section du câble 3 x s Sezione del cavo 3 x s	[mm ²]	1,5	2,5	4	6	10	16	25	35	50	70	95	120	150	185
I _{max} allowable I _{max} admissible I _{max} ammissibile	[A]	23	32	42	54	75	100	127	158	192	246	298	346	399	456
Max. operating temperature Température maximum de service Temperatura max di esercizio	[°C]	90	90	90	90	90	90	90	90	90	90	90	90	90	90

For different environmental temperatures apply the multiplication coefficient K:
 Pour des températures ambiantes différentes appliquer le coefficient multiplicatif K:
 Per temperature diverse applicare il coefficiente moltiplicativo K:

Ambient temperature Température ambiante Temperatura ambiente	[°C]	10	15	20	25	30	35	40	45	50
In the open air A l'air libre In aria libera	K	1,15	1,12	1,08	1,04	1	0,96	0,91	0,87	0,82

If two 3-core cables, multiply the max. permitted current detailed in the chart by the coefficient:
 2 with direct or stator starting (cables in parallel)
 1,73 with star-delta starting
 * Cables in EPDM/EPR are certified for contact with drinking water in accordance with the following regulations: WRAS (Water Regulations Advisory Scheme) according to BS 6920; ACS (Attestation de Conformité Sanitaire) according to DGS/VS4 99/217 and DGS/VS4 2000/232; Ministerial Decree D.M. 174/04.

En utilisant deux câbles tripolaires, multiplier le courant maximum admissible du tableau par le coefficient:
 2 pour démarrage direct ou par stator (câbles en parallèle)
 1,73 pour démarrage étoile-triangle
 * Les câbles en EPDM/EPR sont certifiés au contact direct avec l'eau potable, conformément aux normes: WRAS (Water Regulations Advisory Scheme) suivant la BS 6920; ACS (Attestation de Conformité Sanitaire) suivant les circulaires DGS/VS4 99/217 et DGS/VS4 2000/232; D.M. 174/04.

N.B. Impiegando due cavi, moltiplicare la corrente massima ammissibile di tabella per il coefficiente:
 2 con avviamento diretto o statorico (cavi in parallelo)
 1,73 con avviamento stella-triangolo
 * I cavi in EPDM/EPR sono certificati al contatto con l'acqua potabile, ai sensi delle normative: WRAS (Water Regulations Advisory Scheme) secondo la BS 6920; ACS (Attestation de Conformité Sanitaire) secondo le DGS/VS4 99/217 e DGS/VS4 2000/232; D.M. 174/04.

Maximum permitted current
 Courant maximum admissible
 Corrente massima ammissibile

Tree-wire cables PVC 6" insulated Câbles tripolaires isolés en PVC 6" Cavi tripolari isolati in PVC 6"															
Cable cross-section 3 x s Section du câble 3 x s Sezione del cavo 3 x s	[mm ²]	1,5	2,5	4	6	10	16	25	35	50	70	95	120	150	185
Imax allowable Imax admissible Imax ammissibile	[A]	18,5	25	34	43	60	80	101	126	153	196	238	276	319	364
Max. operating temperature Température maximum de service Temperatura max di esercizio	[°C]	70	70	70	70	70	70	70	70	70	70	70	70	70	70

For different environmental temperatures apply the multiplication coefficient K: Pour des températures ambiantes différentes appliquer le coefficient multiplicatif K: Per temperature diverse applicare il coefficiente moltiplicativo K:											
Ambient temperature Température ambiante Temperatura ambiente	[°C]	10	15	20	25	30	35	40	45	50	
In the open air A l'air libre In aria libera	K	1,22	1,17	1,12	1,06	1	0,94	0,87	0,79	0,71	

If two 3-core cables, multiply the max. permitted current detailed in the chart by the coefficient:
 2 with direct or stator starting (cables in parallel)
 1,73 with star-delta starting

En utilisant deux câbles tripolaires, multiplier le courant maximum admissible du tableau par le coefficient:
 2 pour démarrage direct ou par stator (câbles en parallèle)
 1,73 pour démarrage étoile-triangle

**N.B. Impiegando due cavi, moltiplicare la corrente massima ammissibile di tabella per il coefficiente:
 2 con avviamento diretto o statorico (cavi in parallelo)
 1,73 con avviamento stella-triangolo**

Maximum permitted current
 Courant maximum admissible
 Corrente massima ammissibile

Single-core cables isolated with EPDM/EPR* 6" Câbles unipolaires isolés en EPDM/EPR* 6" Cavi unipolari isolati in EPDM/EPR* 6"														
Cable cross-section 1 x s Section du câble 1 x s Sezione del cavo 1 x s	[mm²]	2,5	4	6	10	16	25	35	50	70	95	120	150	185
I _{max} allowable I _{max} admissible I _{max} ammissibile	[A]	43	58	75	103	138	182	226	275	353	430	500	577	661
Max. operating temperature Température maximum de service Temperatura max di esercizio	[°C]	90	90	90	90	90	90	90	90	90	90	90	90	90

For different environmental temperatures apply the multiplication coefficient K:
 Pour des températures ambiantes différentes appliquer le coefficient multiplicatif K:
 Per temperature diverse applicare il coefficiente moltiplicativo K:

Ambient temperature Température ambiante Temperatura ambiente	[°C]	10	15	20	25	30	35	40	45	50
In the open air A l'air libre In aria libera	K	1,15	1,12	1,08	1,04	1	0,96	0,91	0,87	0,82

If two 3-core cables, multiply the max. permitted current detailed in the chart by the coefficient:
 2 with direct or stator starting (cables in parallel)
 1,73 with star-delta starting
 * Cables in EPDM/EPR are certified for contact with drinking water in accordance with the following regulations: WRAS (Water Regulations Advisory Scheme) according to BS 6920; ACS (Attestation de Conformité Sanitaire) according to DGS/VS4 99/217 and DGS/VS4 2000/232; Ministerial Decree D.M. 174/04.

En utilisant deux câbles tripolaires, multiplier le courant maximum admissible du tableau par le coefficient:
 2 pour démarrage direct ou par stator (câbles en parallèle)
 1,73 pour démarrage étoile-triangle
 * Les câbles en EPDM/EPR sont certifiés au contact direct avec l'eau potable, conformément aux normes: WRAS (Water Regulations Advisory Scheme) suivant la BS 6920; ACS (Attestation de Conformité Sanitaire) suivant les circulaires DGS/VS4 99/217 et DGS/VS4 2000/232; D.M. 174/04.

N.B. Impiegando due cavi, moltiplicare la corrente massima ammissibile di tabella per il coefficiente:
 2 con avviamento diretto o statorico (cavi in parallelo)
 1,73 con avviamento stella-triangolo
 * I cavi in EPDM/EPR sono certificati al contatto con l'acqua potabile, ai sensi delle normative: WRAS (Water Regulations Advisory Scheme) secondo la BS 6920; ACS (Attestation de Conformité Sanitaire) secondo le DGS/VS4 99/217 e DGS/VS4 2000/232; D.M. 174/04.

Maximum permitted current
 Courant maximum admissible
 Corrente massima ammissibile

Single-core cables isolated with PVC 6" Câbles unipolaires isolés en PVC 6" Cavi unipolari isolati in PVC 6"														
Cable cross-section 1 x s Section du câble 1 x s Sezione del cavo 1 x s	[mm ²]	2,5	4	6	10	16	25	35	50	70	95	120	150	185
Imax allowable Imax admissible Imax ammissibile	[A]	26	35	46	63	85	114	143	174	225	275	321	372	427
Max. operating temperature Température maximum de service Temperatura max di esercizio	[°C]	70	70	70	70	70	70	70	70	70	70	70	70	70

For different environmental temperatures apply the multiplication coefficient K: Pour des températures ambiantes différentes appliquer le coefficient multiplicatif K: Per temperature diverse applicare il coefficiente moltiplicativo K:											
Ambient temperature Température ambiante Temperatura ambiente	[°C]	10	15	20	25	30	35	40	45	50	
In the open air A l'air libre In aria libera	K	1,22	1,17	1,12	1,06	1	0,94	0,87	0,79	0,71	

If two 3-core cables, multiply the max. permitted current detailed in the chart by the coefficient:
 2 with direct or stator starting (cables in parallel)
 1,73 with star-delta starting

En utilisant deux câbles tripolaires, multiplier le courant maximum admissible du tableau par le coefficient:
 2 pour démarrage direct ou par stator (câbles en parallèle)
 1,73 pour démarrage étoile-triangle

**N.B. Impiegando due cavi, moltiplicare la corrente massima ammissibile di tabella per il coefficiente:
 2 con avviamento diretto o statorico (cavi in parallelo)
 1,73 con avviamento stella-triangolo**

Max admitted length
Longueur maxi admise
Lunghezze massime ammissibili

3-core EPDM/EPR o PVC* power cables Câbles d'alimentation tripolaires en EPDM/EPR o PVC* Cavi di alimentazione tripolari in EPDM/EPR o PVC*													
Nominal current Intensité nominale Corrente nominale	U Voltage Tension U Tensione U	Cable cross-section 3 (4) x [mm ²] Câble de section 3 (4) x [mm ²] Cavo di sezione 3 (4) x [mm ²]											
		1,5	2,5	4	6	10	16	1,5	2,5	4	6	10	16
I [A]	U [V]	Max length. [m] Longueur maxi admise..... [m] Lunghezza max [m]											
		Single-phase 4" monophasés 4" Monofase 4"						Three-phase motors 4" Moteurs triphasés 4" Motori trifase 4"					

1	230 400	310	514					358	593				
1,5	230 400	206	343	549				238 415	396				
2	230 400	155	257	412				179 311	297 516	476			
2,5	230 400	124	206	330	491			143 249	237 413	381	567		
3	230 400	103	171	275	409			119 207	198 344	317 552	473		
4	230 400	77	128	206	307	523		89 155	148 258	238 414	354		
5	230 400	62	103	165	246	418		72 124	119 206	190 331	284 493	483	
6	230 400	52	86	137	205	349	541	60 104	99 172	159 276	236 411	403	
7	230 400	44	73	118	175	299	463	51 89	85 147	136 236	203 352	345	535
8	230 400	39	64	103	153	261	405	45 78	74 129	119 207	177 308	302 525	468
9	230 400	34	57	92	136	232	360	40 69	66 115	106 184	158 274	268 467	416
10	230 400	31	51	82	123	209	324	36 62	59 103	95 165	142 247	242 420	374
11	230 400	28	47	75	112	190	295	33 57	54 94	86 150	129 224	220 382	340 592
12	230 400	26	43	69	102	174	270	30 52	49 86	79 138	118 205	201 350	312 543
13	230 400	24	40	63	94	161	249	28 48	46 79	73 127	109 190	186 323	288 501
14	230 400	22	37	59	88	149	232	26 44	42 74	68 118	101 176	173 300	267 465
15	230 400	21	34	55	82	139	216	24 41	40 69	63 110	95 164	161 280	250 434
16	230 400	19	32	51	77	131	203	22 39	37 65	59 103	89 154	151 263	234 407
17	230 400	18	30	48	72	123	191	21 37	35 61	56 97	83 145	142 247	220 383
18	230 400	17	29	46	68	116	180	20 35	33 57	53 92	79 137	134 233	208 362
19	230 400	16	27	43	65	110	171	19 33	31 54	50 87	75 130	127 221	197 343
20	230 400	15	26	41	61	105	162	18 31	30 52	48 83	71 123	121 210	187 326

The lengths given in boldface type refer solely to cables in EPDM/EPR.

Les longueurs marquées en caractères gras se réfèrent aux câbles en EPDM/EPR seulement.

Le lunghezze contrassegnate in grassetto sono riferite solo ai cavi in EPDM/EPR.

Make sure that the current considered is effectively that absorbed by the motor in the real operating conditions.

Vérifier que le courant considéré soit effectivement celui absorbé par le moteur dans les conditions réelles de service.

Assicurarsi che la corrente considerata sia effettivamente quella assorbita dal motore nelle condizioni reali d'esercizio.

The cable lengths refer to 30°C ambient temperature; installation in air; 50Hz frequency; cosj = 0.8 and 3% permissible voltage drop. For other operating conditions, refer to the selection procedure detailed: power cables.

Les longueurs des câbles se réfèrent à une température ambiante de 30°C; pose à l'air libre; alimentation 50Hz; cosj = 0,8 et chute de tension admissible = 3%. Pour des conditions différentes voir la procédure de sélection: Câbles d'alimentation.

Le lunghezze dei cavi sono riferite ad una temperatura ambiente di 30°C; installazione in aria; alimentazione 50Hz; cosj = 0,8 e caduta di tensione ammessa = 3%.

Make sure that the section of the riser cable is the same as the section of the motor output cable, or larger.

Vérifier que la section sélectionnée pour le câble de remontée soit supérieure ou égale à la section du câble de sortie moteur.

Per condizioni diverse, verificare accuratamente i parametri di selezione vedi procedura di selezione: cavi di alimentazione. Assicurarsi che la sezione selezionata per il cavo di risalita sia maggiore o uguale alla sezione del cavo d'uscita motore.

Max admitted length
 Longueur maxi admise
 Lunghezze massime ammissibili

Max length [m] - EPDM*/EPR or PVC three-pole power cables
 Longueur maxi admise [m] - EPDM*/EPR ou PVC three-pole power cables
Lunghezza MAX [m] - Cavo di alimentazione Tripolare EPDM*/EPR o PVC

Direct or statoric starting - 3 cables Motor exit- 1 Cable with section (s) 3 x ...
 Demarrage direct ou statorique - Sortie moteur 3 câbles - 1 Câble, section (s) 3 x ...
Avviamento diretto o statorico - Motore con uscita 3 cavi - 1 cavo di sezione (s) 3 x ...

I [A]	S [mm ²]													
	1,5	2,5	4	6	10	16	25	35	50	70	95	120	150	185
2,5	249	413												
5	124	206	331	493										
7,5	83	138	221	329	560									
10	62	103	165	247	420									
15	41	69	110	164	280	434								
20	31	52	83	123	210	326	491							
25		41	66	99	168	261	393	535						
30		34	55	82	140	217	327	446						
40			41	62	105	163	246	334	462					
50				49	84	130	196	267	370	498				
60					70	109	164	223	308	415	516			
70					60	93	140	191	264	356	442	534		
80						81	123	167	231	311	387	468	546	
90						72	109	149	205	277	344	416	486	554
100						65	98	134	185	249	309	374	437	498
120							82	111	154	208	258	312	364	415
140								96	132	178	221	267	312	356
160									116	156	193	234	273	311
180									103	138	172	208	243	277
200										125	155	187	219	249
220										113	141	170	199	226
240										104	129	156	182	208
260											119	144	168	192
280											110	134	156	178
300												125	146	166
320												117	137	156

Make sure that the current considered is effectively that absorbed by the motor in the real operating conditions.

The lengths given in boldface type refer solely to cables in EPDM/EPR

The cable lengths refer to 30[°C] ambient temperature; installation in air; 400[V] 50[Hz] power supply; cosφ = 0.8 and 3% permissible voltage drop.

Check the selection parameters carefully if the conditions are different (see "Calculation of cross-section" and "Maximum permitted current")

Make sure that the section of the riser cable is the same as the section of the motor output cable, or larger.

If the conditions are different, please contact our sales organization.

* The EPDM cables are fit for contact with drinking water, certified by WRAS (Water Regulations Advisory Scheme) in compliance with standard BS 6920.

Vérifier que le courant considéré soit effectivement celui absorbé par le moteur dans les conditions réelles de service.

Les longueurs marquées en caractères gras se réfèrent aux câbles en EPDM/EPR seulement

Les longueurs des câbles se réfèrent à une température ambiante de 30[°C]; pose à l'air libre; alimentation 400[V] 50[Hz]; cosφ = 0,8 et chute de tension admissible = 3%. En cas de conditions différentes, vérifier soigneusement les paramètres de sélection (voir "Calcul de la section" et "Courant maximum admissible").

Vérifier que la section sélectionnée pour le câble de remontée soit supérieure ou égale à la section du câble de sortie moteur.

En cas de conditions différentes, contacter notre service commercial

* Les câbles en EPDM sont indiqués pour le contact avec l'eau potable, certifiés par le WRAS (Water Regulations Advisory Scheme) conformément à la réglementation BS 6920.

Assicurarsi che la corrente considerata sia effettivamente quella assorbita dal motore nelle condizioni reali d'esercizio.

Le lunghezze contrassegnate in grassetto sono riferite solo ai cavi in EPDM/EPR.

Le lunghezze dei cavi sono riferite ad una temperatura ambiente di 30[°C]; installazione in aria; alimentazione 400[V] 50[Hz]; cosφ = 0,8 e caduta di tensione ammessa = 3%.

Per condizioni diverse, verificare accuratamente i parametri di selezione (vedi "Calcolo della sezione" e "Corrente massima ammissibile").

Assicurarsi che la sezione selezionata per il cavo di risalita sia maggiore o uguale alla sezione del cavo d'uscita motore.

Per condizioni diverse, interpellare la sede o la rete di vendita.

* I cavi in EPDM sono idonei al contatto con l'acqua potabile, certificati dal WRAS (Water Regulations Advisory Scheme) secondo la normativa BS 6920

Max admitted length
Longueur maxi admise
Lunghezze massime ammissibili

Max length [m] - EPDM/EPR or PVC Single-pole power cables - Longueur maxi admise [m] - EPDM/EPR ou PVC Unipolaires power cables-
Lunghezza MAX [m] - Cavi di alimentazione unipolari EPDM/EPR o PVC
Direct or statoric starting - 3 cables Motor exit / Demarrage direct ou statorique- Sortie moteur 3 cables / Avviamento diretto o statorico- Motore con uscita 3 cavi
3 Cables wit section (s) 1 x ... / 3 Câble, section (s) 1 x ... / 3 cavi di sezione (s) 1 x ... / 6 Câble cross-section (s) 1 x ... / 6 Câble de section (s) 1 x ... / 6 cavi di sezione (s) 1 x ...

Table with columns for I [A], DN, S [mm²] and rows for cable sizes 4, 6, 8-9-10, 12, 15, 20, 25, 30, 40, 50, 60, 70, 80, 90, 100, 120, 140, 160, 180, 200, 220, 240, 260, 280, 300, 320.

Make sure that the current considered is effectively that absorbed by the motor in the real operating conditions.

The lengths given in boldface type refer solely to cables in EPDM/EPR

The cable lengths refer to 30°C ambient temperature; installation in air; 400V [50Hz] power supply; cosφ = 0,8 and 3% permissible voltage drop. Check the selection parameters carefully if the conditions are different (see "Calculation of cross-section" and "Maximum permitted current")

Make sure that the section of the riser cable is the same as the section of the motor output cable, or larger.

If the conditions are different, please contact our sales organization.

* The EPDM cables are fit for contact with drinking water, certified by WRAS (Water Regulations Advisory Scheme) in compliance with standard BS 6920.

Vérifier que le courant considéré soit effectivement celui absorbé par le moteur dans les conditions réelles de service.

Les longueurs marquées en caractères gras se réfèrent aux câbles en EPDM/EPR seulement

Les longueurs des câbles se réfèrent à une température ambiante de 30°C; pose à l'air libre; alimentation 400V [50Hz]; cosφ = 0,8 et chute de tension admissible = 3%. En cas de conditions différentes, vérifier soigneusement les paramètres de sélection (voir "Calcul de la section" et "Courant maximum admissible").

Vérifier que la section sélectionnée pour le câble de remontée soit supérieure ou égale à la section du câble de sortie moteur.

En cas de conditions différentes, contacter notre service commercial

* Les câbles en EPDM sont indiqués pour le contact avec l'eau potable, certifiés par le WRAS (Water Regulations Advisory Scheme) conformément à la réglementation BS 6920.

Assicurarsi che la corrente considerata sia effettivamente quella assorbita dal motore nelle condizioni reali d'esercizio.

Le lunghezze contrassegnate in grassetto sono riferite solo ai cavi in EPDM/EPR.

Le lunghezze dei cavi sono riferite ad una temperatura ambiente di 30°C; installazione in aria; alimentazione 400V [50Hz]; cosφ = 0,8 e caduta di tensione ammessa = 3%. Per condizioni diverse, verificare accuratamente i parametri di selezione (vedi "Calcolo della sezione" e "Corrente massima ammissibile").

Assicurarsi che la sezione selezionata per il cavo di risalita sia maggiore o uguale alla sezione del cavo d'uscita motore.

Per condizioni diverse, interpellare la sede o la rete di vendita.

* I cavi in EPDM sono idonei al contatto con l'acqua potabile, certificati dal WRAS (Water Regulations Advisory Scheme) secondo la normativa BS 6920

Max admitted length
 Longueur maxi admise
 Lunghezze massime ammissibili

Max length [m] - EPDM*/EPR or PVC three-pole power cables - Longueur maxi admise [m] - EPDM*/EPR ou PVC three-pole power cables Lunghezza MAX [m] - Cavo di alimentazione Tripolare EPDM*/EPR o PVC
Star-delta starting - 6 cables Motor exit / Démarrage étoile-triangle - Sortie moteur 6 câbles / Avviamento stella-triangolo - Motore con uscita 6 cavi 2 Cables wit section 3 x ... / 2 Câble, section (s) 3 x ... / 2 cavi di sezione (s) 3 x ...

I [A]	S [mm ²]													
	1,5	2,5	4	6	10	16	25	35	50	70	95	120	150	185
10	93	155	248	370										
15	62	103	165	247	420									
20	47	77	124	185	315	488								
25	37	62	99	148	252	391	589							
30	31	52	83	123	210	326	491							
40		39	62	92	158	244	368	502						
50		31	50	74	126	195	295	401	554					
60			41	62	105	163	246	334	462					
70			35	53	90	140	210	287	396	534				
80				46	79	122	184	251	347	467	580			
90				41	70	109	164	223	308	415	516			
100					63	98	147	201	277	374	464	561		
120					53	81	123	167	231	311	387	468	546	
140						70	105	143	198	267	331	401	468	534
160						61	92	125	173	233	290	351	410	467
180							82	111	154	208	258	312	364	415
200							74	100	139	187	232	281	328	374
220								91	126	170	211	255	298	340
240								84	116	156	193	234	273	311
260								77	107	144	178	216	252	287
280									99	133	166	200	234	267
300									92	125	155	187	219	249
320									87	117	145	175	205	234

Make sure that the current considered is effectively that absorbed by the motor in the real operating conditions.

The lengths given in boldface type refer solely to cables in EPDM/EPR

The cable lengths refer to 30[°C] ambient temperature; installation in air; 400[V] 50[Hz] power supply; cosφ = 0.8 and 3% permissible voltage drop. Check the selection parameters carefully if the conditions are different (see "Calculation of cross-section" and "Maximum permitted current")

Make sure that the section of the riser cable is the same as the section of the motor output cable, or larger.

If the conditions are different, please contact our sales organization.

* The EPDM cables are fit for contact with drinking water, certified by WRAS (Water Regulations Advisory Scheme) in compliance with standard BS 6920.

Vérifier que le courant considéré soit effectivement celui absorbé par le moteur dans les conditions réelles de service.

Les longueurs marquées en caractères gras se réfèrent aux câbles en EPDM/EPR seulement.

Les longueurs des câbles se réfèrent à une température ambiante de 30[°C] ; pose à l'air libre; alimentation 400[V] 50[Hz]; cosφ = 0,8 et chute de tension admissible = 3%. En cas de conditions différentes, vérifier soigneusement les paramètres de sélection (voir "Calcul de la section" et "Courant maximum admissible").

Vérifier que la section sélectionnée pour le câble de remontée soit supérieure ou égale à la section du câble de sortie moteur.

En cas de conditions différentes, contacter notre service commercial

* Les câbles en EPDM sont indiqués pour le contact avec l'eau potable, certifiés par le WRAS (Water Regulations Advisory Scheme) conformément à la réglementation BS 6920.

Assicurarsi che la corrente considerata sia effettivamente quella assorbita dal motore nelle condizioni reali d'esercizio.

Le lunghezze contrassegnate in grassetto sono riferite solo ai cavi in EPDM/EPR.

Le lunghezze dei cavi sono riferite ad una temperatura ambiente di 30[°C]; installazione in aria; alimentazione 400[V] 50[Hz]; cosφ = 0,8 e caduta di tensione ammessa = 3%. Per condizioni diverse, verificare accuratamente i parametri di selezione (vedi "Calcolo della sezione" e "Corrente massima ammissibile").

Assicurarsi che la sezione selezionata per il cavo di risalita sia maggiore o uguale alla sezione del cavo d'uscita motore.

Per condizioni diverse, interpellare la sede o la rete di vendita.

* I cavi in EPDM sono idonei al contatto con l'acqua potabile, certificati dal WRAS (Water Regulations Advisory Scheme) secondo la normativa BS 6920

Max admitted length
Longueur maxi admise
Lunghezze massime ammissibili

Max length [m] - EPDM/EPR or PVC Single-pole power cables - Longueur maxi admise [m] - EPDM/EPR ou PVC Unipolaires power cables - Lunghezza MAX [m] - Cavi di alimentazione unipolari EPDM/EPR o PVC

Star-delta starting - 6 cables Motor exit / Démarrage étoile-triangle - Sortie moteur 6 câbles / Avviamento stella-triangolo - Motore con uscita 6 cavi 6 Cables wit section (s) 1 x ... / 6 Câble, section (s) 1 x ... / 6 cavi di sezione (s) 1 x ...

I [A]	DN _{pompa}	S [mm ²]												
		2,5	4	6	10	16	25	35	50	70	95	120	150	185
10	4"	153	243	359	600									
	6"	152	242	356	593									
	8"-9"-10"	152	241	356	591									
	12"	152	241	354	587									
15	4"	102	162	239	400									
	6"	101	161	237	395	597								
	8"-9"-10"	101	161	237	394	594								
	12"	101	160	236	391	588								
20	4"	76	121	179	300	455								
	6"	76	121	178	297	448								
	8"-9"-10"	76	121	178	296	446								
	12"	76	120	177	293	441								
25	4"	61	97	143	240	364	535							
	6"	61	97	142	237	358	522							
	8"-9"-10"	61	97	142	237	357	519							
	12"	61	96	142	235	353	510							
30	4"	51	81	120	200	304	446	595						
	6"	51	81	119	198	298	435	575						
	8"-9"-10"	51	80	119	197	297	432	570						
	12"	51	80	118	196	294	425	558						
40	4"	38	61	90	150	228	335	446	597					
	6"	38	60	89	148	224	326	432	571					
	8"-9"-10"	38	60	89	148	223	324	428	564					
	12"	38	60	88	147	220	319	419	549					
50	4"	31	49	72	120	182	268	357	477					
	6"	30	48	71	119	179	261	345	457	587				
	8"-9"-10"	30	48	71	118	178	259	342	451	579				
	12"	30	48	71	117	176	255	335	439	558				
60	4"	25	40	60	100	152	223	297	398	518				
	6"	25	40	59	99	149	218	288	380	489	589			
	8"-9"-10"	25	40	59	99	149	216	285	376	482	579			
	12"	25	40	59	98	147	213	279	366	465	554			
70	4"	22	35	51	86	130	191	255	341	444	541			
	6"	22	35	51	85	128	187	247	326	419	505	589		
	8"-9"-10"	22	34	51	84	127	185	244	322	413	496	578		
	12"	22	34	51	84	126	182	239	313	399	475	549		
80	4"	30	45	75	114	167	223	298	388	473	560			
	6"	30	45	74	112	163	216	285	367	442	516	587		
	8"-9"-10"	30	44	74	111	162	214	282	362	434	505	574		
	12"	30	44	73	110	160	209	274	349	416	481	542	600	
90	4"	27	40	67	101	149	198	265	345	421	497	573		
	6"	27	40	66	99	145	192	254	326	393	468	522	582	
	8"-9"-10"	27	40	66	99	144	190	251	321	386	449	510	567	
	12"	27	39	65	98	142	186	244	310	370	427	482	533	
100	4"	24	36	60	91	134	178	239	311	379	448	516	582	
	6"	24	36	59	90	131	173	228	294	353	413	470	524	
	8"-9"-10"	24	36	59	89	130	171	226	289	347	404	459	511	
	12"	24	35	59	88	128	167	219	279	333	385	434	480	
120	4"	30	50	76	112	149	199	259	316	373	430	485		
	6"	30	49	75	109	144	190	245	295	344	391	437		
	8"-9"-10"	30	49	74	108	143	188	241	289	337	382	426		
	12"	29	49	73	106	140	183	233	277	320	361	400		
140	4"				43	65	96	127	170	222	271	320	368	416
	6"				42	64	93	123	163	210	252	295	336	374
	8"-9"-10"				42	64	93	122	161	207	248	289	328	365
	12"				42	63	91	120	157	199	238	275	310	343
160	4"				37	57	84	112	149	194	237	280	322	364
	6"				37	56	82	108	143	183	221	258	294	328
	8"-9"-10"				37	56	81	107	141	181	217	253	287	319
	12"				37	55	80	105	137	174	208	240	271	300
180	4"				51	74	99	133	173	210	249	286	323	
	6"				50	73	96	127	163	196	229	261	291	
	8"-9"-10"				50	72	95	125	161	193	225	255	284	
	12"				49	71	93	122	155	185	214	241	266	
200	4"				46	67	89	119	155	189	224	258	291	
	6"				45	65	86	114	147	177	206	235	262	
	8"-9"-10"				45	65	86	113	145	174	202	229	255	
	12"				44	64	84	110	140	166	192	217	240	
220	4"				41	61	81	108	141	172	203	234	265	
	6"				41	59	78	104	133	161	188	214	238	
	8"-9"-10"				41	59	78	103	131	158	184	209	232	
	12"				40	58	76	100	127	151	175	197	218	
240	4"				56	74	99	129	158	187	215	242		
	6"				54	72	95	122	147	172	196	218		
	8"-9"-10"				54	71	94	121	145	168	191	213		
	12"				53	70	91	116	139	160	181	200		
260	4"				51	69	92	120	146	172	198	224		
	6"				50	66	88	113	136	159	181	202		
	8"-9"-10"				50	66	87	111	134	155	177	196		
	12"				49	64	84	107	128	148	167	184		
280	4"				48	64	85	111	135	160	184	208		
	6"				47	62	82	105	126	147	168	187		
	8"-9"-10"				46	61	81	103	124	144	164	182		
	12"				46	60	78	100	119	137	155	171		
300	4"				45	59	80	104	126	149	172	194		
	6"				44	58	76	98	118	138	157	175		
	8"-9"-10"				43	57	75	96	116	135	153	170		
	12"				43	56	73	93	111	128	145	160		
320	4"				56	75	97	118	140	161	182			
	6"				54	71	92	110	129	147	164			
	8"-9"-10"				53	71	90	109	126	143	160			
	12"				52	69	87	104	120	136	150			

Make sure that the current considered is effectively that absorbed by the motor in the real operating conditions.
The lengths given in boldface type refer solely to cables in EPDM/EPR

The cable lengths refer to 30°C ambient temperature; installation in air: 400[V] 50[Hz] power supply; cosφ = 0.8 and 3% permissible voltage drop. Check the selection parameters carefully if the conditions are different (see "Calculation of cross-section" and "Maximum permitted current")

Make sure that the section of the riser cable is the same as the section of the motor output cable, or larger.

If the conditions are different, please contact our sales organization.

* The EPDM cables are fit for contact with drinking water, certified by WRAS (Water Regulations Advisory Scheme) in compliance with standard BS 6920.

Vérifier que le courant considéré soit effectivement celui absorbé par le moteur dans les conditions réelles de service.

Les longueurs marquées en caractères gras se réfèrent aux câbles en EPDM/EPR seulement

Les longueurs des câbles se réfèrent à une température ambiante de 30°C ; pose à l'air libre; alimentation 400[V] 50[Hz]; cosφ = 0,8 et chute de tension admissible = 3%. En cas de conditions différentes, vérifier soigneusement les paramètres de sélection (voir "Calcul de la section" et "Courant maximum admissible").

Vérifier que la section sélectionnée pour le câble de remontée soit supérieure ou égale à la section du câble de sortie moteur.

En cas de conditions différentes, contacter notre service commercial

* Les câbles en EPDM sont indiqués pour le contact avec l'eau potable, certifiés par le WRAS (Water Regulations Advisory Scheme) conformément à la réglementation BS 6920.

Assicurarsi che la corrente considerata sia effettivamente quella assorbita dal motore nelle condizioni reali d'esercizio.

Le lunghezze contrassegnate in grassetto sono riferite solo ai cavi in EPDM/EPR.

Le lunghezze dei cavi sono riferite ad una temperatura ambiente di 30°C; installazione in aria; alimentazione 400[V] 50[Hz]; cosφ = 0,8 e caduta di tensione ammessa = 3%. Per condizioni diverse, verificare accuratamente i parametri di selezione (vedi "Calcolo della sezione" e "Corrente massima ammissibile").

Assicurarsi che la sezione selezionata per il cavo di risalita sia maggiore o uguale alla sezione del cavo d'uscita motore.

Per condizioni diverse, interpellare la sede o la rete di vendita.

* I cavi in EPDM sono idonei al contatto con l'acqua potabile, certificati dal WRAS (Water Regulations Advisory Scheme) secondo la normativa BS 6920

Generator power
Puissance du générateur
Potenza del generatore

When an electric generator has to be used to supply the motor, it should be carefully selected.
 A chart is provided giving the minimum rating in kW and kVA of the generators used to supply the motors.

*Dans le cas d'utilisation d'un générateur électrique pour alimenter le moteur, le choix doit être avisé.
 Nous fournissons un tableau indicatif des puissances minimum en kW et en kVA des générateurs pour l'alimentation des moteurs électriques*

**Quando si deve utilizzare un generatore elettrico per l'alimentazione del motore, è necessaria un'oculata scelta.
 Forniamo una tabella indicativa delle potenze minime in kW ed in kVA dei generatori per l'alimentazione dei motori elettrici.**

Electric motor power <i>Puissance moteur électrique</i> Potenza motore elettrico		Generator power <i>Puissance du générateur</i> Potenza del generatore	
		Direct starting <i>Démarrage direct</i> Avviamento diretto	
[kW]	[HP]	[kW]	[kVA]
2.2	3	6	7.5
3	4	8	10
4	5,5	10	12,5
5,5	7,5	12,5	15,6
7,5	10	15	18,8
9,2	12,5	18,8	23,5
11	15	22,5	28
13	17,5	26,4	33
15	20	30	38
18,5	25	40	50
22	30	45	57
26	35	52	65
30	40	60	75
37	50	75	94
45	60	90	112
51	70	105	131
59	80	120	150
66	90	135	170
75	100	150	190
92	125	185	230
110	150	210	260

Electric motor power <i>Puissance moteur électrique</i> Potenza motore elettrico		Generator power <i>Puissance du générateur</i> Potenza del generatore	
		Star-delta starting <i>Démarrage étoile-triangle</i> Avviamento stella-triangolo	
[kW]	[HP]	[kW]	[kVA]
-	-	-	-
3	4	6	7,5
4	5,5	8	10
5,5	7,5	10,8	13,5
7,5	10	14	17,5
9,2	12,5	17,2	21,5
11	15	20,5	25,5
13	17,5	23,6	29,5
15	20	27	34
18,5	25	33	42
22	30	40	50
26	35	45	57
30	40	52	65
37	50	65	81
45	60	77	97
51	70	90	112
59	80	102	128
66	90	115	144
75	100	128	160
92	125	158	198
110	150	190	237

VALUES VALEURS GRANDEZZA		ALTERNATING CURRENT COURANT ALTERNATIF CORRENTE ALTERNATA	
		SINGLE-PHASE MONOPHASE MONOFASE	THREE-PHASE TRIPHASE TRIFASE
Absorbed power (active) <i>Puissance absorbée (active)</i> Potenza assorbita (attiva)	[kW]	$P_a = \frac{U \cdot I \cdot \cos \varphi}{1000}$	$P_a = \frac{1,73 \cdot U \cdot I \cdot \cos \varphi}{1000}$
Yield power <i>Puissance utile</i> Potenza resa	[kW]	$P_r = \frac{U \cdot I \cdot \cos \varphi \cdot \eta_M}{1000}$	$P_r = \frac{1,73 \cdot U \cdot I \cdot \cos \varphi \cdot \eta_M}{1000}$
Absorbed current <i>Courant absorbé</i> Corrente assorbita	[A]	$I = \frac{P_r \cdot 1000}{U \cdot \cos \varphi \cdot \eta_M}$	$I = \frac{P_r \cdot 1000}{1,73 \cdot U \cdot \cos \varphi \cdot \eta_M}$
Power factor (cos φ) <i>Facteurs de puissance (cos φ)</i> Fattore di potenza (cos φ)	[0,.....]	$\cos \varphi = \frac{P_a \cdot 1000}{U \cdot I}$	$\cos \varphi = \frac{P_a \cdot 1000}{1,73 \cdot U \cdot I}$
Nominal torque <i>Couple nominal</i> Coppia nominale	[Nm]	$M_N = \frac{P_r \cdot 1000}{0,105 \cdot n}$	
Motor efficiency <i>Rendement du moteur</i> Rendimento motore	[%]	$\eta_M = \frac{P_r}{P_a} \cdot 100$	
Synchronous speed <i>Vitesse de synchronisme</i> Velocità sincrona	[n ⁻¹]	$n_s = \frac{f \cdot 120}{\text{No. Poli / Poles / Pôles}}$	
Sliding <i>Glissement</i> Scorrimento	[%]	$S = \frac{n_s - n}{n_s} \cdot 100$	

Electrical tolerances
Tolérances électriques
Tolleranze elettriche

Tolerances on the guaranteed values of the electrical characteristics of asynchronous motors as per CEI norms in accordance with IEC norms.

Tolérances sur les valeurs garanties des caractéristiques électriques des moteurs asynchrones selon les Normes CEI en accord avec les Normes IEC.

Tolleranze sui valori garantiti delle caratteristiche elettriche dei motori asincroni, secondo Norme CEI in accordo con le Norme IEC.

VALUE VALEURS GRANDEZZA		TOLERANCE TOLERANCE TOLLERANZA
Real efficiency <i>Rendement réel</i> Rendimento effettivo	[η]	$- 0,15 \cdot (1 - \eta_G) [\%]$
Power factor <i>Facteur de puissance</i> Fattore di potenza	[cos φ]	$- \frac{1}{6} \cdot (1 - \cos \varphi) \left[\begin{array}{l} \text{nim: } 0,02 \\ \text{max: } 0,07 \end{array} \right]$
Sliding <i>Glissement</i> Scorrimento	[S]	± 20%

VALUE VALEURS GRANDEZZA		TOLERANCE TOLERANCE TOLLERANZA
Maximum torque <i>Couple maximal</i> Coppia massima	[M _m]	- 10% (min 1,6 M _N) [Nm]
Starting torque <i>Couple de démarrage</i> Coppia di spunto	[M _s]	+ 25% - 15%
Starting current <i>Intensité de démarrage</i> Corrente di spunto	[I _s]	+ 20% [A]

Asynchronous motors absorb, from the main, "apparent" electrical power which is partly "active" power, and partly "reactive" power; the latter is used for motor magnetization and cannot be technically eliminated.

The ratio of "active power" to "apparent power" forms the "power factor" or $\cos \varphi$.

The absorbed reactive power on the line can be reduced, according with the current rules, modifying the phase displacement between absorbed current and supply tension.

Everything must be realised using an appropriate power capacitors battery.

Les moteurs asynchrones absorbent sur le réseau une puissance électrique "apparente" constituée en partie d'une puissance "active" et en partie d'une puissance "réactive".

Cette dernière sert à la magnétisation du moteur et ne peut pas être techniquement supprimée.

Le rapport entre "puissance active" et "puissance apparente" constitue le "facteur de puissance" ou $\cos \varphi$.

La puissance réactive absorbée sur la ligne peut être réduite, selon les normes en vigueur, en modifiant le déphasage entre courant absorbé et tension d'alimentation.

Ceci devra être réalisé en utilisant une adéquate batterie des condensateurs de puissance.

I motori asincroni assorbono dalla rete potenza elettrica "apparente" costituita in parte da potenza "attiva" ed in parte da potenza "reattiva"; quest'ultima serve alla magnetizzazione del motore e non può essere tecnicamente soppressa.

Il rapporto fra "potenza attiva" e "potenza apparente" costituisce il "fattore di potenza", o $\cos \varphi$.

La potenza reattiva assorbita sulla linea può essere ridotta, in base alle norme vigenti, modificando lo sfasamento tra corrente assorbita e la tensione di alimentazione. Ciò dovrà essere realizzato utilizzando opportuna batteria di condensatori di potenza.

Nomogram for determining P_c power [kVAR] of phase-shift capacitors
 Nomogramme pour la détermination de la puissance P_c [kVAR] des condensateurs de rattrapage.
 Nomogramma per la determinazione della potenza P_c [kVAR] dei condensatori di rifasamento.

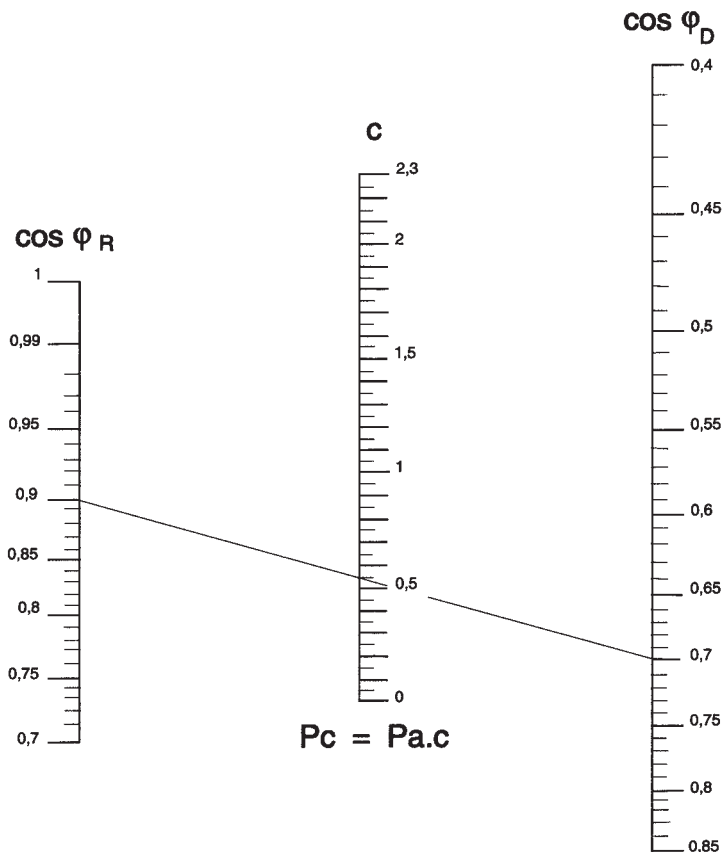

Example:

Electrical input (active) P_a motor = 20 kW
 Available power factor $\cos \varphi_D = 0,7$
 Required power factor $\cos \varphi_R = 0,9$
 Multiplying factor (from nomogram) $c = 0,54$
 Phase-shift capacitor power P_c
 $P_c = P_a \times c = 20 \times 0,54 = 10,8$ kVAR

Exemples:

*Puissance absorbée (active) du moteur $P_a = 20$ kW
 Factor de puissance disponible $\cos \varphi_D = 0,7$
 Factor de puissance recherchée $\cos \varphi_R = 0,9$
 Facteur multiplicatif (du monogramme) $c = 0,54$
 Puissance des condensateurs P_c
 $P_c = P_a \times c = 20 \times 0,54 = 10,8$ kVAR*

Esempio:

**Potenza attiva motore $P_a = 20$ kW
 Fattore di potenza disponibile $\cos \varphi_D = 0,7$
 Fattore di potenza richiesto $\cos \varphi_R = 0,9$
 Fattore moltiplicativo da nomogramma $c = 0,54$
 Potenza del condensatore di rifasamento P_c
 $P_c = P_a \times c = 20 \times 0,54 = 10,8$ kVAR**

Accessories
Accessoires
Accessori

DCL Low level safety device
DCL Dispositif pour défaut d'eau et contrôle niveau
DCL Dispositivo contro la marcia a secco e controllo del livello

The conductivity electronic device DCL, is used for monitoring the levels of conductive liquids in wells, tanks or reservoirs.

In the case of minimum and maximum level control (prevention of dry running and automatic reset of the electric pump), the relay is at rest until the liquid reaches the upper level.

At this point the relay starts working thereby exciting the remote control switch coil (causing the electric pump to start and keeps this state until the liquid drows down below the minimum level.

During minimum level checking (prevention of dry running) relay remains constantly excited if pumped liquids is available.

Relay is not excited when there is no liquid or voltage lacks.

If so, relay must be manually reset.

Le dispositif électroniques à conductivité DCL, sert à relever ou à contrôler les niveau du liquide conducteur dans les puits, les baches ou les réservoirs.

En cas de contrôle du niveau minimum ou maximum (protection contre la marche à sec et remise en marche automatique de l'électropompe), le relais se maintient en situation de repos tant que le liquide n'a pas atteint le niveau supérieur.

A ce point, le relais excite la bobine du télérupteur (qui provoque le démarrage de l'électropompe) et la maintient jusqu'à ce que le liquide descend sous le niveau minimum.

Quand on va vérifier le niveau minimum (protection contre la marche à sec) le relais reste toujours excité en présence du liquide pompé. Il n'est pas excité en absence du liquide ou quand la tension manque. Dans cette occasion le relais doit être rearmé manuellement.

I dispositivo elettronico a conduttività DCL, serve a rilevare o controllare i livelli dei liquidi conduttivi in pozzi, vasche o serbatoi.

Nel caso di controllo di minimo e massimo livello (protezione contro la marcia a secco e riavviamento automatico della elettropompa), il relè si mantiene in stato di riposo fintanto che il liquido non ha raggiunto il livello superiore.

A questo punto, il relè entra in conduzione eccitando la bobina del teleruttore (che provoca, tramite l'apparecchiatura elettrica, l'avviamento dell'elettropompa) e mantiene tale stato finché il liquido non scende sotto in livello minimo.

Nel caso di semplice controllo di minimo livello (protezione contro la marcia a secco), il relè rimane costantemente eccitato in presenza del liquido dissecandosi in assenza di questo o per mancanza di tensione e deve essere riarmato manualmente.

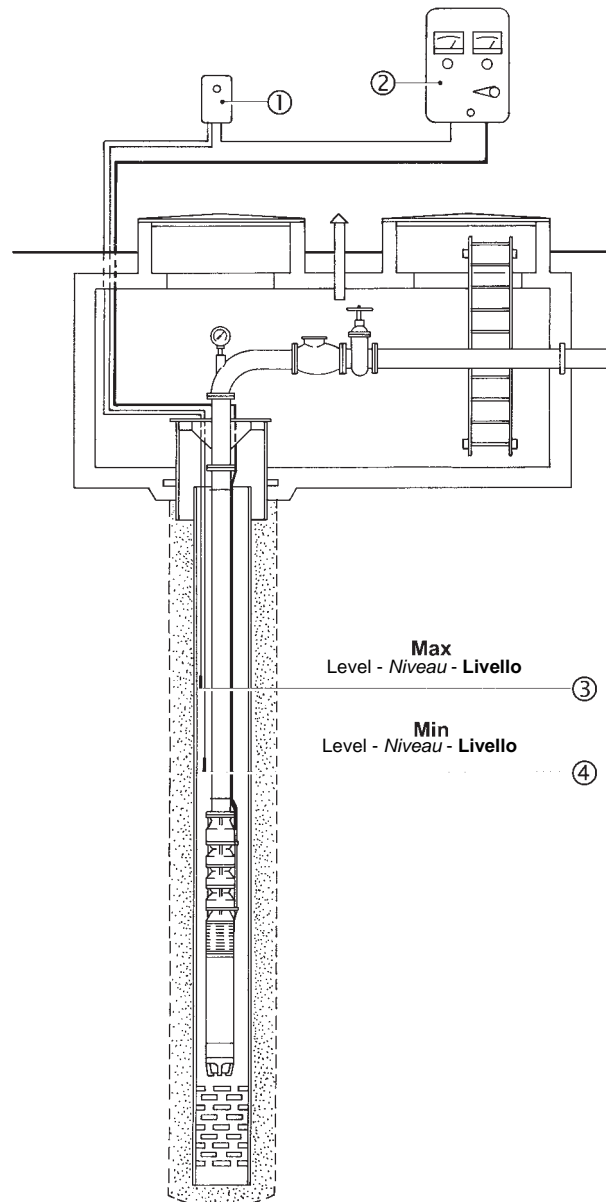

- 1) Low level safety device
- 2) Electric equipment
- 3) Maximum level electric probe
- 4) Minimum level electric probe

- 1) Dispositif complet pour défaut d'eau
- 2) Appareillage électrique
- 3) Sondes électriques au max. de niveau
- 4) Sondes électriques au min. de niveau

- 1) Dispositivo contro la marcia a secco
- 2) Apparecchiatura elettrica
- 3) Sonda elettrica max. livello
- 4) Sonda elettrica min. livello

T-412 Temperature monitoring device for submersed electric motors
T-412 Appareillage de contrôle de la température des moteurs électriques immergés
T-412 Apparecchiatura di controllo temperatura motori elettrici sommersi

T412 monitors the temperature inside the electric motor.

Connected to the PT100 probe (housed in the electric motor), it is able to read operating temperatures from 0-200°C.

T412 is supplied without a setting.

L'appareillage T412 sert à contrôler la température interne du moteur électrique.

Branché à la sonde PT100 (logée à l'intérieur du moteur électrique) il permet la lecture de la température de fonctionnement entre 0-200°C.

L'appareillage T412 est fourni sans réglage.

L'apparecchiatura T412, serve a monitorare la temperatura interna del motore elettrico.

Collegata alla sonda PT100 (alloggiata all'interno del motore elettrico) permette la lettura della temperatura di funzionamento tra 0-200°C . L'apparecchiatura T412 viene fornita senza il settaggio.

How to make the setting:

- Start the electric pump and set it to the operating point with the highest power input. The internal temperature will rise progressively and will be monitored by the probe. When it has reached full rate (this may take up to 2 hours, depending on the motor), the temperature reading will stabilize.
- Once the temperature has become stable, select a value equal to the temperature reading +3°C for the first alarm setting. The alarm must record the excess temperature so as to produce documentation upon the first inspection;
- The setting for the second alarm, which must stop the motor, must equal the temperature reading +6°C; the excess temperature recording can be automatic, but must occur with a delay of at least 15 minutes from the stopping action or when the internal temperature of the motor is 20°C less than the alarm temperature setting;
ACTIVATION OF THE 2nd ALARM, WHICH STOPS THE MOTOR, WILL OCCUR WHEN:
 - There is an overload
 - There is a poor cooling action
 - There are too frequent starts

With the motor rotor wound in:

- In PVC, the maximum temperature setting of the second alarm must be 58°C
- In PE2+PA, the maximum temperature setting of the second alarm must be 75°C.
This device can also be used for monitoring the temperature of bearings, lubricants, in surface electric motors and machinery in general.
The device complies with electromagnetic compatibility standards CEI EN-50081-2 and 50082-2.
Dimensions: 48*96 mm DIN 43700
depth:130 mm.

Mode de réglage :

- Mettre l'électropompe en marche et se placer dans le point de travail où la puissance absorbée est la plus élevée, la température interne augmentera progressivement et sera relevée par la sonde. Au régime établi (deux heures peuvent s'écouler, suivant le type de moteur) la température lue se stabilisera.
- Quand la température est stable, régler la première alarme à une valeur égale à la température lue +3°C, l'alarme doit enregistrer le dépassement pour en faire l'acquisition au premier contrôle;
- La deuxième alarme, qui doit commander l'arrêt du moteur, devra être étalonnée à une valeur égale à la température lue +6°C; le redémarrage, avec enregistrement du dépassement, peut être automatique mais doit avoir lieu avec un retard, par rapport à l'arrêt, d'au moins 15 minutes ou à une température interne du moteur inférieure de 20°C par rapport à la température de réglage de l'alarme.
L'INTERVENTION DE LA 2e ALARME, AVEC ARRÊT DU MOTEUR, SE PRODUIT:
 - En cas de surcharge ;
 - En cas de refroidissement insuffisant;
 - En cas de démarrages trop fréquents.

Avec moteur à rotor bobiné:

- En PVC, la température maximum de réglage de la deuxième alarme est de 58°C.
- En PE2+PA, la température maximum de réglage de la deuxième alarme est de 75°C.
Ce dispositif pourra aussi être utilisé pour contrôler les températures des roulements, des lubrifiants, dans les moteurs électriques de surface et dans les machines en général.
L'appareillage est conforme aux normes de compatibilité électromagnétique CEI EN-50081-2 et 50082-2.
Dimensions: 48*96 mm DIN 43700
profondeur: 130 mm.

Modalità per il settaggio:

- Avviare l'elettropompa e posizionarsi nel punto di lavoro a maggiore potenza assorbita, la temperatura nel suo interno crescerà progressivamente e verrà monitorata dalla sonda. A regime (a seconda del motore possono trascorrere fino a 2 ore) la temperatura letta si stabilizzerà.
- A lettura stabile della temperatura tarare il primo allarme ad un valore pari alla temperatura letta +3°C, l'allarme deve registrare il superamento per averne documentazione alla prima ispezione;
- Il secondo allarme, che deve comandare l'arresto del motore, dovrà essere tarato ad un valore pari alla temperatura letta +6°C; il riavviamento, con registrazione del superamento, può essere automatico ma deve avvenire con un ritardo dall'arresto di almeno 15 minuti o a una temperatura interna del motore inferiore di 20°C rispetto alla temperatura settata di allarme;
L'INTERVENTO DEL 2° ALLARME, CON ARRESTO DEL MOTORE, AVVIENE QUANDO :
 - C'è un sovraccarico
 - C'è uno scarso raffreddamento
 - Ci sono frequenti avviamenti

Con il motore avvolto :

- In PVC la massima temperatura di settaggio del secondo allarme potrà essere di 58°C
- In PE2+PA la massima temperatura di settaggio del secondo allarme potrà essere di 75°C.
Tale dispositivo potrà essere utilizzato anche per monitorare le temperature dei cuscinetti, dei lubrificanti, nei motori elettrici di superficie e nelle macchine operatrici in generale.
L'apparecchiatura rispetta le norme di compatibilità elettromagnetica CEI EN-50081-2 e 50082-2.
Dimensioni : 48*96 mm DIN 43700
profondità: 130 mm.

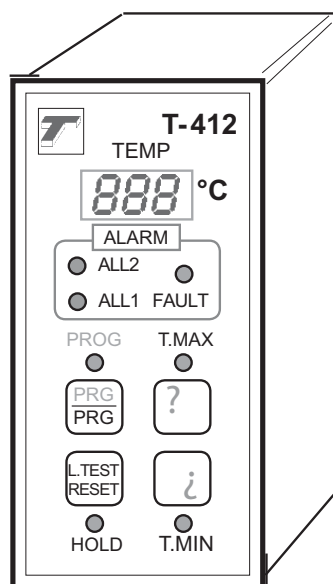

T-412

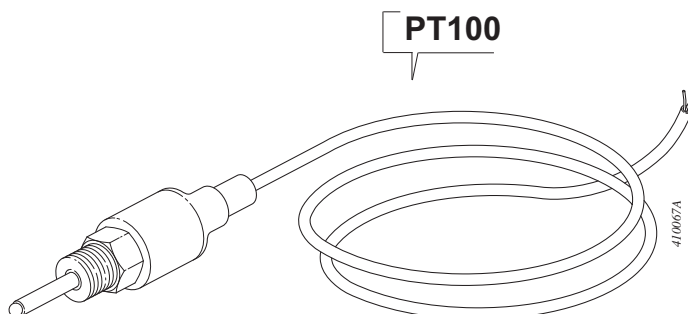

PT100

MEI = 0.4 for Multistage Submersible 2900rpm

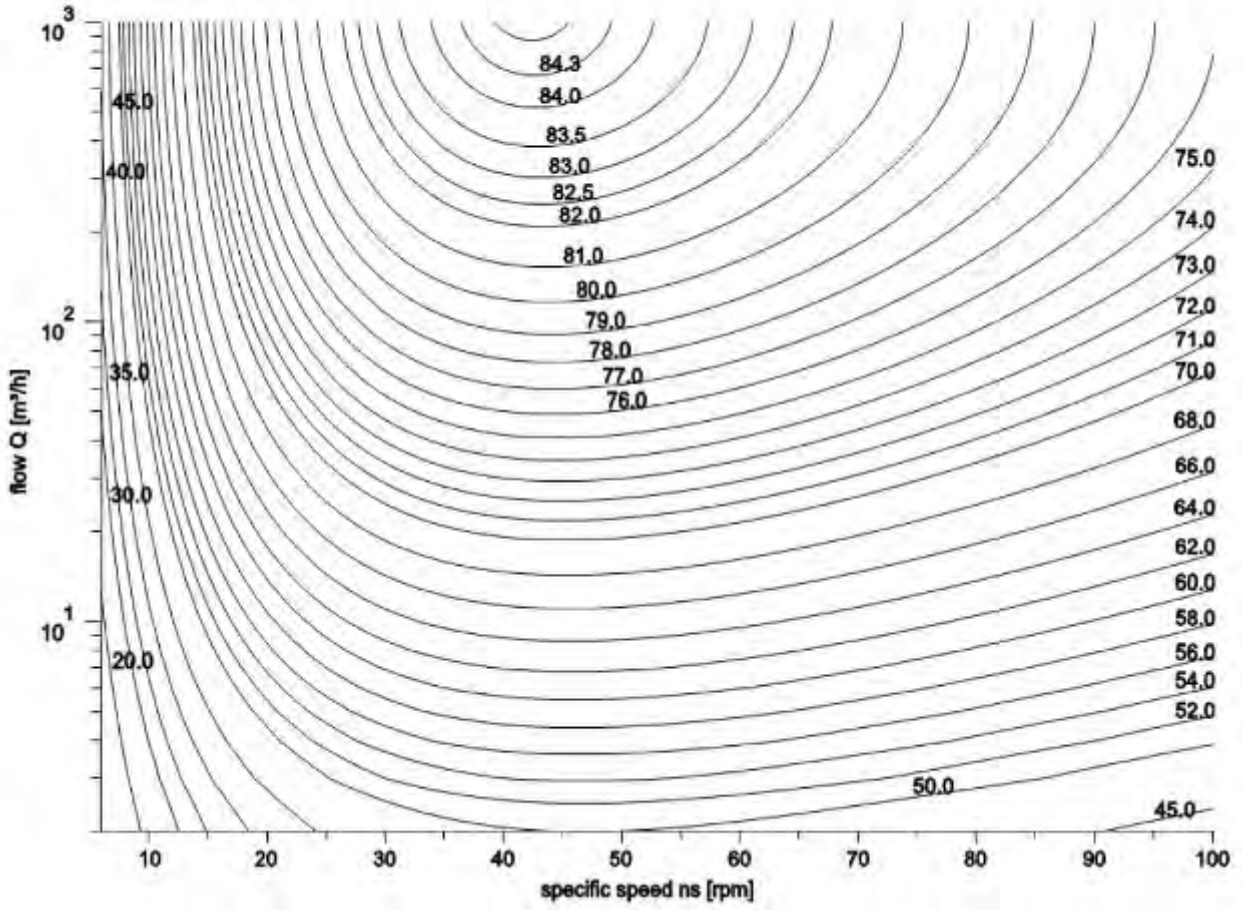

MEI = 0.7 for Multistage Submersible 2900 rpm

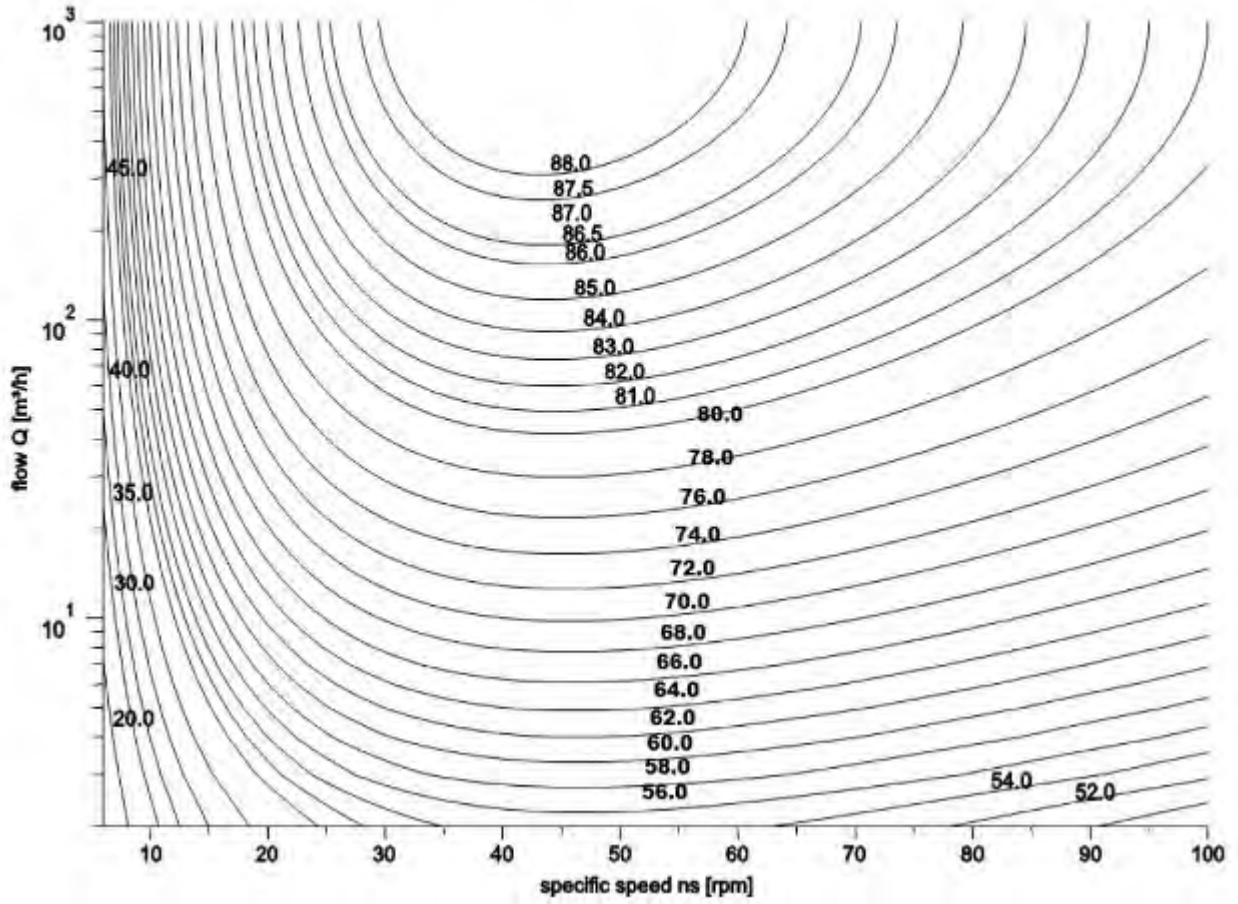

Caprari pumps are coated with WRAS approved paint

Les pompes Caprari utilisent des peintures certifiées WRAS.

Le pompe Caprari utilizzano vernici certificate WRAS.

caprari

*The dimensions have an indicative value. Executive drawing will be supplied on request upon order.
CAPRARI S.p.A. reserves the right to make changes to improve its products at any time and without any notice*

*Les dimensions sont fournies à titre indicatif. Le plan bon pour exécution sera fourni sur demande au moment de la commande.
CAPRARI S.p.A. se réserve la faculté d'apporter des modifications visant à améliorer ses propres produits à tout moment et sans aucun préavis.*

**Le dimensioni hanno valore indicativo. Il disegno esecutivo sarà fornito su richiesta in fase d'ordine.
CAPRARI S.p.A. si riserva facoltà di apportare modifiche atte a migliorare i propri prodotti in qualsiasi momento e senza preavviso alcuno.**