

Product groups and ranges.

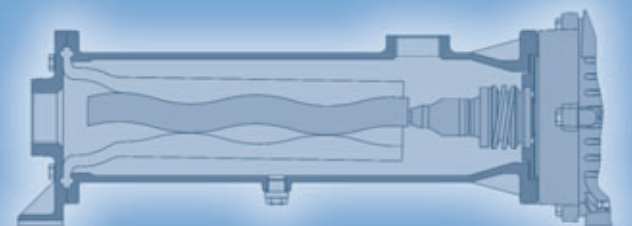
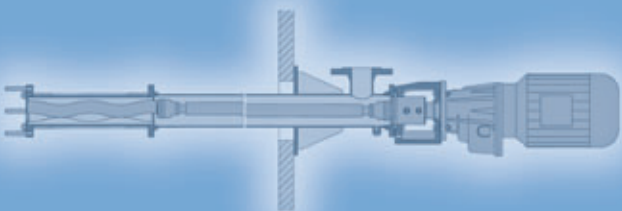
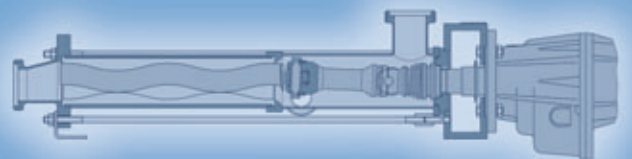
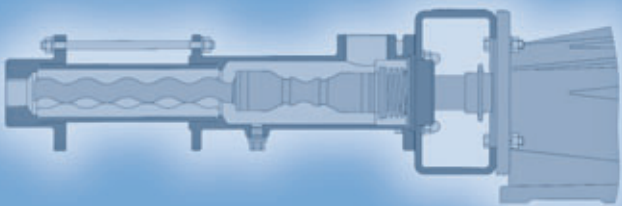
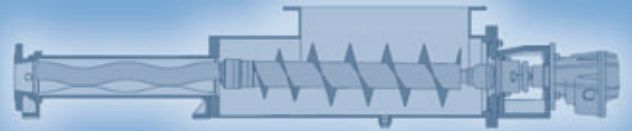
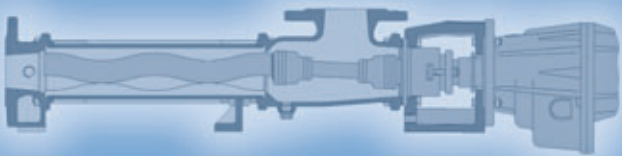

# Welcome to seepex.

seepex is a leading global supplier of products and services for conveying and controlling liquids.

The first seepex progressive cavity pump was manufactured in 1972 in Bottrop, Germany. Today nearly 330 of our 520 worldwide employees work here on the development, manufacture and distribution of progressive cavity pumps, macerators and control systems to suit our customers current and future needs.



In addition to highly modern production facilities, other areas of technological excellence in Bottrop are departments and laboratories for basic research, product development / planning as well as information technology.

For over 30 years we have been helping environmental engineers, companies dealing in foods and beverages, the chemical and paper industries, oil and gas production and industries ranging from agriculture to the zoological parks by providing them with the optimal technical and economical solutions for their conveying problems.

We have created this foundation through competent application expertise in form of consultation, development, project management and delivery. Our product and industry specialists develop tailor-made solutions for the most diverse applications. Using our modular pump system we can design a pump specifically for each application. This ensures lower energy consumption, reduced maintenance costs, increased operational safety, better utilisation of capacity and higher productivity and profits for our clients.

seepex offers you these products and services – through a worldwide sales and service network.

# The pump modular system.

seepex makes progressive cavity pumps with a characteristic feature: the conveying elements are formed by the intersecting geometries of a helical rotor and a double internal helical stator. They are manufactured using a modern quality management system that satisfies the highest technical specifications, and are manufactured exclusively with the most modern technologies. Each pump is designed according to the unique requirements of the industry sector, application and product being pumped.

This has been the basis for the development of our modular pump system. There are 8 product groups in all and 27 ranges with capacities from 0.1 l/h to 500 m<sup>3</sup>/h (1 cc/min. to 2200 GPM) and differential pressures of up to 48 bar (720 psi). Whether you need to transport extremely viscous media, precisely meter the smallest quantities, maintain the highest levels of hygiene, or resist the erosion caused by abrasive solids – there is a seepex solution for the most extreme applications.

When investing in a pumping system, the purchase costs only constitute a small proportion of the total investment. Consideration must be given to the life cycle costs of the entire system. Installation and commissioning costs, energy consumption, maintenance and repair costs, the expense of idle equipment and production downtimes must be kept as low as possible in the interests of efficiency and productivity.

You can achieve this through the high technical standards inherent in our pumps. The application specific construction and our extensive service program enhance each phase of the life of the pump.

seepex progressive cavity pumps in general:

## **Wide application range**

They are particularly suitable for handling abrasive and even aggressive products with all degrees of viscosity. They can be used on fluids at temperatures of between -20°C and +180°C (0°F–360 °F) and can transport products with a capacity of 0.1 l/h up to 500 m<sup>3</sup>/h (1 cc/min. to 2200 GPM), independent of discharge pressure or the DS content of the product. Differential pressures of up to 48 bar (720 psi), and higher in special cases, are available.

## **Gentle, precise and trouble-free**

Handling sensitive products often requires a pump with specific characteristics incorporating low shear rates, accurate metering/flow together with minimum pulsation. seepex progressive cavity pumps incorporate all these qualities. Additionally they have no check valves to clog and the cavities within the pump progress from the suction to the discharge without changing their shape.

## **High suction lift capabilities**

Typical for seepex: Excellent self priming characteristics, even on gaseous liquids are possible to 9 m, 27 ft. with reliable operation.

## **Versatile**

Integration of a seepex progressive cavity pump into a customer's facility is easily accomplished, as they can be installed horizontally, vertically or in almost any position. Pump flow is reversible with shaft rotation. Versatility can be further extended by fitting various options of open hoppers and feeding arrangements to assist non flowable products into the pumping elements, the rotor/stator.

## **Service-friendly**

seepex progressive cavity pumps are designed to be very service-friendly. The drive shaft plug-in connection, the universal joints, the sealing arrangements and the external flange with thru-bolt construction all contribute to the service-friendly character of our designs. It is a guiding principle of all seepex designs.

## **Economical**

seepex guarantees state of the art products, the highest quality of all components, optimised design and manufacturing capabilities to increase efficiencies resulting in a long pump life time and low operating costs.

# N – Standard pumps

The two ranges of pumps within the product group N form the basis of all seepex progressive cavity pumps. They are available with various rotor/stator geometries (conventional, 6L, even wall and Tricam) and can be applied in virtually all industrial sectors – for conveying thin to viscous media with or without solids.

## Features

- Minimal pulsation, controlled flow, so that no pulsation dampers or compensators are required
  - Self-priming, even with air or gas liquid mixtures of up to 9 m (29.5') of water
  - Installation versatility as pumps can be mounted either horizontally or vertically and the suction casing can be rotated
  - Products with solids can be conveyed gently without damage
  - Direction of rotation and fluid flow are reversible
- > Conveying capacity: up to 500 m<sup>3</sup>/h (2200 GPM),  
Pressure: up to 48 bar (720 psi)

## Range BN

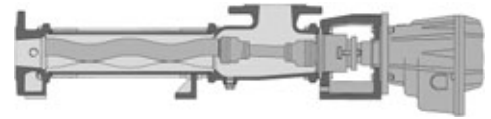

## Range NS/N

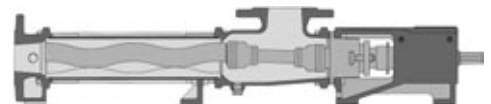

# T – Open hopper pumps

There are 9 ranges of open hopper pumps. They are used for viscous media that have only little or no flowability. T pumps have a feed hopper and an auger feed screw to positively feed the product into the pumping elements.

## Features

- These pumps incorporate an open hopper and auger feed screw which enables highly viscous products to be fed into the pumping elements
  - The pitch and diameter of the auger can be adjusted according to operating conditions for optimal product feed
  - The feed hopper can be designed to suit diverse application conditions
  - Pump hoppers can be fitted with integral bridge breakers
  - Range BTM pumps incorporate patented cutting knives for chopping and crushing the pumped product
- > Conveying capacity: up to 500 m<sup>3</sup>/h (2200 GPM),  
Pressure: up to 48 bar (720 psi)

## Range BTQ

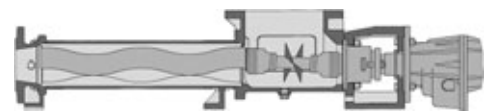

## Range BT

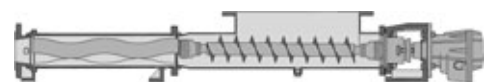

## Range BTM

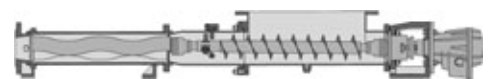

# T – Open hopper pumps

Range BTE \_\_\_\_\_

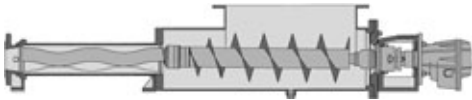

Range BTI \_\_\_\_\_

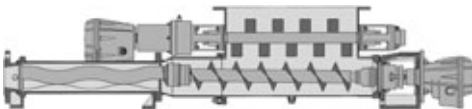

Range BTHE/BTH \_\_\_\_\_

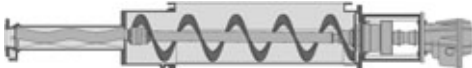

Range BTES \_\_\_\_\_

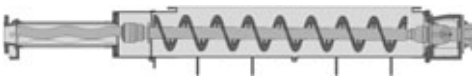

Range BTEI \_\_\_\_\_

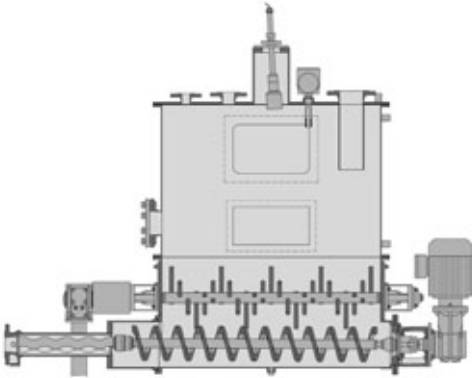

# CS – Food grade pumps

The 3 product ranges of the CS product group are used primarily in the food, pharmaceutical, cosmetics and chemical industries. "C" stands for CIP (Cleaning in Place) and "S" for SIP-capability (Sterilisation In Place) of the pumps. CS pumps satisfy the highest requirements with regard to gentle conveying, sanitation, cleaning and sterilisation. They are certified acc. to the 3-A Sanitary Standard of the US and designed in compliance with the EHEDG directives

## Features

- Gentle handling of flowable and high viscosity products with controllable flows and pressures
- Easy cleaning: optimised pump casing designs with minimal residual volume that provide simple CIP operations
- Service-friendly with easily disassembled universal joints
- Sanitary mechanical seals selected for the respective application
- Stator materials and secondary seals with FDA approval available
- SIP with steam is an available option with cycled operation of the pump

> Conveying capacity: up to 130 m<sup>3</sup>/h (575 GPM),  
Pressure: up to 24 bar (360 psi)

Range BCSD

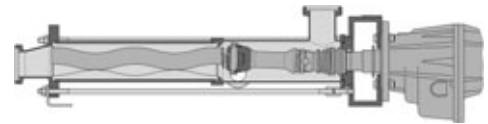

Range BCSB

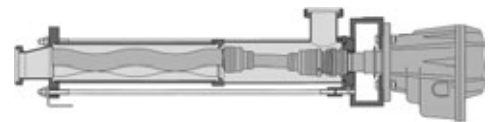

Range BTCS

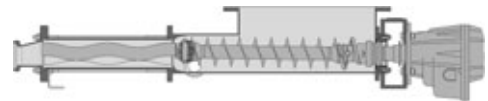

# D – Dosing pumps

The 6 ranges of dosing pumps can be used in virtually all industries for the metering and dosing of precise quantities. They are particularly good for low-pulsation conveying of low to high viscosity fluids, as well as media containing solids and those that are chemically aggressive.

## Features

- Simple interchangeability due to their modular construction
- Low pulsation, no pulsation dampeners required
- High metering accuracy (deviation  $\pm 1\%$ )
- Constant flow, independent of pressure
- Eliminates control valves
- No ball valves to clog

> Conveying capacity: up to 1000 l/h (380 gph),  
Pressure: up to 24 bar (360 psi)

Range MD

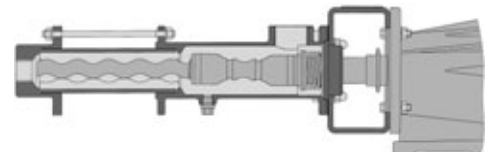

Range MDP

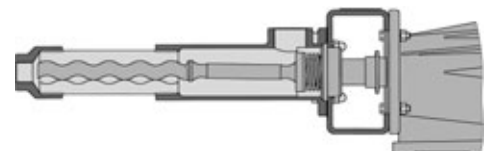

Range MDC

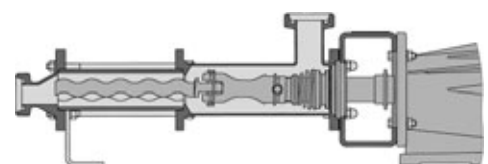

# D – Dosing pumps

Range MDTC

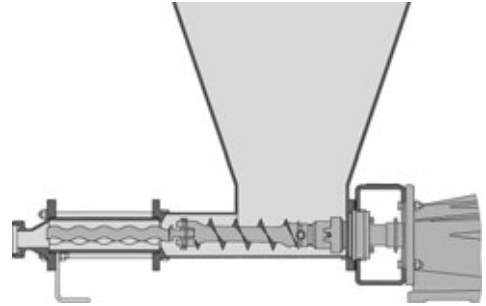

Range MDT

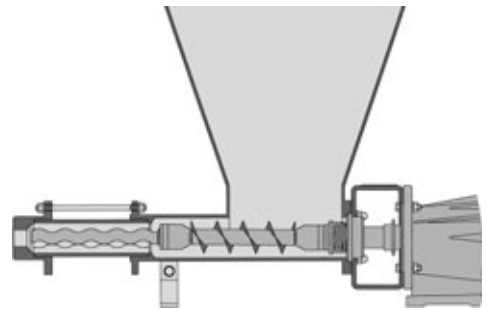

Range MDF

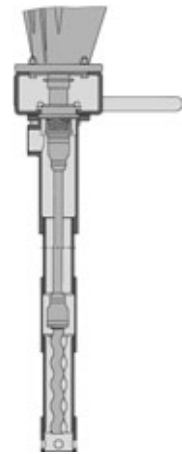

# E – Semi-submersible pumps

Semi-submersible pumps are installed vertically. They pump liquids of different viscosities, which may be abrasive or even corrosive. Due to their high efficiencies, a minimal footprint and their maintenance-friendly design, seepex semi-submersible pumps have low life-cycle costs and are a viable alternative to other pump systems.

### Features

- Service-friendly with a standard atmospherically cooled drive
- Customised lengths
- Various installation configurations are available to suit the most unusual applications
- Space-saving construction
- Overcomes NPSHA limitations

> Conveying capacity: up to 300 m<sup>3</sup>/h (1300 GPM),  
Pressure: up to 12 bar (180 psi)

**Range BE**  
Semi-submersible variant U

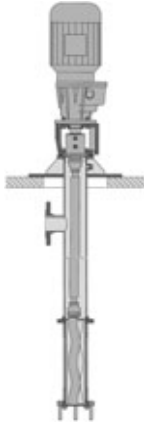

**Range BE**  
Semi-submersible variant O

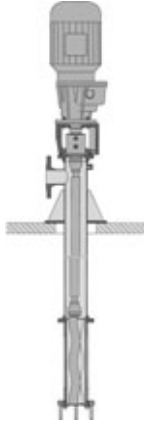

**Range BE**  
Semi-submersible variant K



**Range BE**  
Semi-submersible variant W





# W – Wobble pumps

Wobble pumps in block design perform well in almost all industries. They convey liquids of all viscosities, even those with high solids, are very simple to use and particularly efficient.

## Features

- Service-friendly and particularly efficient: simple pump structure, rapid replacement of pumping elements
  - Space-saving with a short, compact design, direct flange-mounted drive (block design)
  - Flexible stator, fixed on one end
  - Rotating unit with only one universal joint
- > Conveying capacity: up to 10 m<sup>3</sup>/h (45 GPM),  
Pressure: up to 4 bar (60 psi)

## Range BW

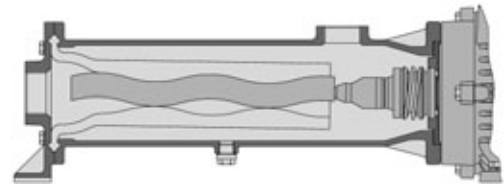

# M – Macerators

While the 2 ranges of seepex macerators are primarily used for municipal and industrial wastewater, they are also used for diverse applications in other industries. They chop almost all solid and fibrous components and increase the operating time and service life of the downstream equipment. The degree of maceration can be controlled by varying the flow rate, the drive speed and the shear plate design.

## Features

- Longer service life and increase of operational safety of downstream equipment
  - Lower power requirements than other macerating methods due to the unique cutting principle
  - Controlled maceration by using shear plates with holes of different sizes and variable drive speeds
  - Service-friendly with simple replacement of the complete cartridge-style headstock
  - An optional integrated heavy solids separation unit
- > Flow rate: up to 150 m<sup>3</sup>/h (660 GPM)

## Range U

with solids separator

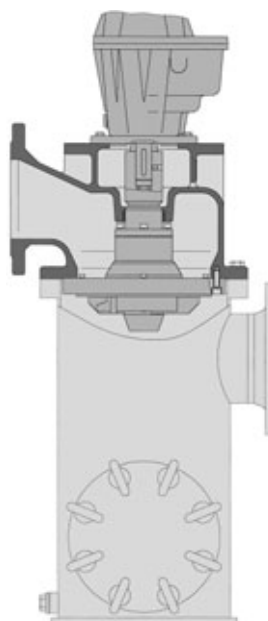

## Range I

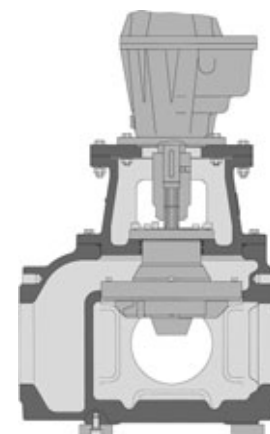

# CO – Control systems

We tailor our control systems (CO = Control) to optimise the pump and the process. Standardised modules are available for dosing applications and the pumps protection, e.g. over-pressure or dry-running. In addition, we provide individualised control solutions by consulting with our customers which can include component supply or complete panel design.

### Features

- Single source supply of pumps and controls
- Development of customer-specific solutions can be integrated with seepex products
- Simple integration into existing systems
- Standardised modules
- Network-compatible compact controllers
- Competent support including project planning and commissioning
- Optimises pump and process

### Switch cupboard

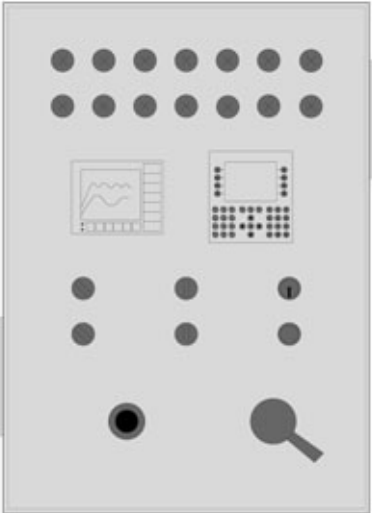

### Control module

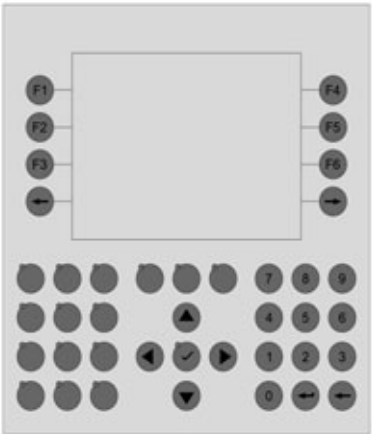

# seepex products in particular.

seepex products have been used very successfully and are proven for the most difficult conveying duties. The modular design consisting of 8 product groups and 27 ranges enables

the most economical and technical solution to be selected for each application. It's no surprise that our pumps are indispensable in many industrial areas.

Product groups	>	N	CS	T	D	E	W	M	CO
<b>Environmental Technology</b>									
Domestic waste water treatment		•		•	•	•	•	•	•
Industrial waste water treatment		•		•	•	•	•	•	•
Flocculant metering		•			•	•			•
Sludge dewatering		•		•			•		•
Chemical dosing		•			•	•			•
Flue gas desulfuration		•		•			•		
Oil-water-separation		•			•	•	•		
<b>Utilities/Disposal</b>									
Fresh-water conditioning		•		•	•		•		
Transport of landfill drainage water		•			•	•	•		
Chemical dosing		•			•	•			•
<b>Galvanic</b>									
Chemical dosing		•			•	•			•
Disposal of process waste		•		•	•	•	•	•	
<b>Food/Beverage Industry</b>									
Dairy		•		•		•			
Processed fruit and beverages		•	•	•	•	•	•		
Wine production		•	•	•		•	•		•
Processed vegetables and meat		•	•	•	•	•	•		
Breweries		•	•	•	•	•	•		•
<b>Pharmaceutical/Cosmetic Industry</b>									
Dryer feeding		•					•		
Metering of additives		•	•	•	•	•			
Filling of endproducts		•	•	•	•	•	•		
<b>Fish Industry</b>									
Fish meal production		•		•			•		
Fish processing		•	•	•	•	•	•	•	
Fish feeding		•		•		•	•	•	
Fish transportation		•		•		•	•	•	
<b>Petrochemical/Oil Production/Offshore</b>									
Bilge-pumping		•				•	•		•
Oil-water-separation		•					•		
Transportation of waste water and excrements		•			•	•	•	•	
Drilling mud treatment		•		•	•	•	•		
Drainage and fire fighting		•		•		•	•		
Production of chemicals		•		•	•	•	•		
<b>Mining</b>									
Auxiliary dewatering stations		•				•	•		
Sump dewatering		•		•		•	•		
Dedusting		•					•		
Flocculant metering		•				•			•
Pressure filter feeding		•					•		•
Back filling and grout		•		•			•		
<b>Paper and Cellulose Industry</b>									
Stock preparation		•		•	•	•	•	•	
Paper/cardboard production		•		•		•	•		
Coating processing		•			•		•		
Adhesive and pigment processing		•			•		•		
Coater feed		•					•		
Metering of chemicals		•			•				•
Waste water treatment		•		•	•	•	•	•	•



Product groups	>	N	CS	T	D	E	W	M	CO
<b>Dyeing Industry</b>									
Metering and filling of colors		•	•	•	•	•			•
Component metering		•	•		•	•			•
Latex foaming		•	•		•		•		
Waste water treatment		•		•	•	•	•	•	•
<b>Ships</b>									
Bilgewater handling		•					•		
Oil-water separation		•			•	•	•		
Liquid-mud transport		•					•		
Waste disposal		•		•		•	•	•	
<b>Textile Industry</b>									
Dye metering		•	•	•	•	•			
Transport of printing ink		•			•	•	•		
Feeding of Latex coaters		•			•	•	•		
<b>Automotive/Equipment</b>									
Dewaxing		•			•	•	•		
Mobile dewatering		•		•	•		•		
Transport of sealing compounds and protective coatings		•		•	•	•	•		
Waste oil disposal		•		•	•	•	•		
Paint and enamel processing		•			•	•	•		
<b>Building Industry</b>									
Plaster and gypsum		•		•			•		
Concrete coloring		•			•	•	•		
Tunnel grout		•		•			•		
Waste water/sludge treatment		•			•	•	•	•	•
Dewatering		•				•	•		•
<b>Wood Processing</b>									
Production of partical boards and MDF boards		•			•	•	•		
Lime metering		•			•	•			
Metering of additives		•			•	•			
<b>Chemical/Biochemical Industry</b>									
Polymer production		•	•	•	•	•	•		
Metering of additives		•	•	•	•	•			
Processing of reaction agents		•	•	•	•	•	•		
Dispersion handling		•	•	•	•	•	•		
<b>Sugar Industry</b>									
Processing of sugar cane and beets		•		•		•	•		
Diffusion, saturation, thickening		•		•		•	•		
Crystalization		•		•			•		
Centrate		•		•			•		
Waste water treatment		•		•	•	•	•	•	•
<b>Ceramic Industry</b>									
Handling of suspensions		•		•			•		
Metering of additives		•			•				
<b>Agriculture</b>									
Feeding plants		•		•	•	•	•		•
Liquid manure transportation		•				•	•	•	
Bio gas plant		•		•	•	•	•	•	
Irrigation systems		•					•		

# The seepex speciality: system solutions.

seepex is not only well known as leader in the manufacture of progressive cavity pumps, but it is increasingly recognised by its customers as expert in the design and supply of customised fluid/product-handling solutions. seepex's highly qualified engineers are outstanding in their professionalism, their knowledge of pumps, their applications and the industry sectors they support. They take pride in their ability to listen, understand customer's problems and create innovative engineering solutions that bring results.

seepex progressive cavity pumps and accessories, include piping, fittings and measuring devices as well as electronic controllers. These are optimized and integrated for each specific application. We consider the complete engineering task, including documentation and project planning.

#### **For example, seepex system solutions include**

- Pump systems for specific metering applications including PLC controllers and instrumentation
- Assembly of one or more pumps on special skids with associated pipe work
- Process controllers and control cabinets
- Reception hoppers and handling systems for dewatered sludge
- Pumps with engine drives on portable skids
- Pumps on trolleys

Additionally, we offer a complete Aftersales portfolio which includes installation and commissioning together with a full range of services to support the pump throughout the complete life cycle.

Europe:

**Great Britain**

**seepex**  
UK Ltd.  
3 Armtch Row  
Houndstone Business Park  
Yeovil Somerset BA22 8RW  
Tel +44.19 35.47 23 76  
Fax +44.19 35.47 98 36  
sales@seepex.co.uk

**Austria**

**seepex**  
Vertriebsbüro Österreich  
Obermüllergasse 18  
A-3003 Gablitz  
Tel +43.22 31.6 10 85  
Fax +43.22 31.6 10 85 20  
hfriedl@seepex.com

**Belgium**

**seepex**  
Bureau België/Belgique  
Dorp 8  
B-2288 Bouwel  
Tel +32.14.50 14 71  
Fax +32.14.50 14 61  
seepex.be@seepex.com

**Denmark**

**seepex**  
Nordic AS  
Bakkegårdsvej 411  
DK-3050 Humlebæk  
Tel +45.49 19 22 00  
Fax +45.49 19 32 00  
info@seepex.dk

**France**

**seepex**  
France SARL  
1, Rue Pelloutier  
F-77183 Croissy Beaubourg  
Tel +33.1.64 11 44 50  
Fax +33.1.64 11 44 69  
info.fr@seepex.com

**Ireland**

**seepex**  
Branch Office Ireland  
No 5 Arden Glas  
Portlaoise  
Co. Laois  
Tel +353.5 78 68 18 26  
Fax +353.5 78 68 15 87  
mryan@seepex.co.uk

**Italy**

**seepex** GmbH  
Ufficio di Rappresentanza per l'Italia  
Piazza Luigi di Savoia, 22  
20124 Milano  
Tel +39.02.36 56 93 60  
Fax +39.02.92 87 78 53  
info.it@seepex.com

**Sweden**

**seepex**  
Nordic AS  
Hamndalsvägen 58  
S-61633 Åby  
Tel +46.1 16 69 40  
Fax +46.1 16 69 41  
info@seepex.dk

North America:

**The Netherlands**

**seepex**  
Bureau Nederland  
Maagdenburgstraat 22c  
NL-7421 ZC Deventer  
Tel +31.570.51 66 44  
Fax +31.570.51 60 77  
seepex.nl@seepex.com

**USA**

**seepex**  
Inc.  
511 Speedway Drive  
Enon  
Ohio 45323  
Tel +1.937.8 64 71 50  
Fax +1.937.8 64 71 57  
sales@seepex.net

Asia:

**China**

**seepex**  
Pumps (Shanghai) Co., Ltd.  
Xuanzhong Rd. 399, Building 13  
Nanhui Industrial Area  
201300 Shanghai  
Tel +86.21.38 10 88 88  
Fax +86.21.38 10 88 99  
info.cn@seepex.com

**Japan**

**seepex**  
Japan Co., Ltd.  
Keyaki Building  
Nakano-sakaue #101,  
2-31-5 Chuo, Nakano-ku,  
Tokyo 164-0011  
Tel +81.3 57 55 59 71  
Fax +81.3 57 55 59 72  
info.jp@seepex.com

**Malaysia**

**seepex**  
(M) Sdn. Bhd.  
59-1, Jalan PJU 1/37  
Dataran Prima  
47301 Petaling Jaya  
Selangor Darul Ehsan  
Tel +60.3.78 80 69 51  
Fax +60.3.78 80 69 59  
seepex.m@seepex.com

And what can we get flowing for you? Your nearest contact:

**More seepex sales partners in  
Europe, America, Asia, Africa  
and Oceania you will find on  
our website.**

Or visit [www.seepex.com](http://www.seepex.com)