



Sub TWI-A 4

Article no.	Description
4067802	TWI4-0206-DM
4068823	TWI4-0206-EM
4068865	TWI4-0206-EMSC
4067803	TWI4-0208-DM
4068824	TWI4-0208-EM
4068866	TWI4-0208-EMSC
4067804	TWI4-0213-DM
4068825	TWI4-0213-EM
4068867	TWI4-0213-EMSC
4068918	TWI4-0217-DM
4068826	TWI4-0217-EM
4068868	TWI4-0217-EMSC
4067805	TWI4-0221-DM
4068827	TWI4-0221-EM
4068869	TWI4-0221-EMSC
4067806	TWI4-0225-DM
4068828	TWI4-0225-EM
4068870	TWI4-0225-EMSC
4067807	TWI4-0230-DM
4068829	TWI4-0230-EM
4068871	TWI4-0230-EMSC
4067808	TWI4-0235-DM
4068830	TWI4-0235-EM
4068872	TWI4-0235-EMSC
4067809	TWI4-0240-DM
4068831	TWI4-0240-EM
4068873	TWI4-0240-EMSC
4067810	TWI4-0247-DM
4068832	TWI4-0247-EM
4068874	TWI4-0247-EMSC
4067811	TWI4-0254-DM
4068833	TWI4-0254-EM
4068875	TWI4-0254-EMSC
4067812	TWI4-0260-DM

Sub TWI-A 4

Article no.	Description
4068711	TWI4-0266-DM
4068712	TWI4-0272-DM
4068713	TWI4-0306-DM
4068834	TWI4-0306-EM
4068876	TWI4-0306-EMSC
4068714	TWI4-0309-DM
4068835	TWI4-0309-EM
4068877	TWI4-0309-EMSC
4068715	TWI4-0312-DM
4068836	TWI4-0312-EM
4068878	TWI4-0312-EMSC
4068716	TWI4-0315-DM
4068837	TWI4-0315-EM
4068879	TWI4-0315-EMSC
4068717	TWI4-0318-DM
4068838	TWI4-0318-EM
4068880	TWI4-0318-EMSC
4068718	TWI4-0322-DM
4068839	TWI4-0322-EM
4068881	TWI4-0322-EMSC
4068719	TWI4-0325-DM
4068840	TWI4-0325-EM
4068882	TWI4-0325-EMSC
4068720	TWI4-0330-DM
4068841	TWI4-0330-EM
4068883	TWI4-0330-EMSC
4068721	TWI4-0336-DM
4068842	TWI4-0336-EM
4068884	TWI4-0336-EMSC
4068722	TWI4-0344-DM
4068723	TWI4-0351-DM
4068724	TWI4-0357-DM
4068725	TWI4-0362-DM
4068726	TWI4-0368-DM

Sub TWI-A 4

Article no.	Description
4068727	TWI4-0404-DM
4068843	TWI4-0404-EM
4068885	TWI4-0404-EMSC
4068728	TWI4-0407-DM
4068844	TWI4-0407-EM
4068886	TWI4-0407-EMSC
4068729	TWI4-0409-DM
4068845	TWI4-0409-EM
4068887	TWI4-0409-EMSC
4068730	TWI4-0414-DM
4068846	TWI4-0414-EM
4068888	TWI4-0414-EMSC
4068731	TWI4-0419-DM
4068847	TWI4-0419-EM
4068889	TWI4-0419-EMSC
4068732	TWI4-0424-DM
4068848	TWI4-0424-EM
4068890	TWI4-0424-EMSC
4068733	TWI4-0429-DM
4068849	TWI4-0429-EM
4068891	TWI4-0429-EMSC
4068734	TWI4-0434-DM
4068735	TWI4-0439-DM
4068736	TWI4-0445-DM
4068737	TWI4-0450-DM
4068919	TWI4-0454-DM
4068738	TWI4-0460-DM
4068739	TWI4-0466-DM
4068740	TWI4-0472-DM
4068741	TWI4-0703-DM
4068850	TWI4-0703-EM
4068892	TWI4-0703-EMSC
4068742	TWI4-0704-DM
4068851	TWI4-0704-EM

Sub TWI-A 4

Article no.	Description
4068893	TWI4-0704-EMSC
4068743	TWI4-0706-DM
4068852	TWI4-0706-EM
4068894	TWI4-0706-EMSC
4068744	TWI4-0709-DM
4068853	TWI4-0709-EM
4068895	TWI4-0709EMSC
4068745	TWI4-0713-DM
4068854	TWI4-0713-EM
4068896	TWI4-0713-EMSC
4068746	TWI4-0716-DM
4068855	TWI4-0716-EM
4068897	TWI4-0716-EMSC
4068747	TWI4-0719-DM
4068856	TWI4-0719-EM
4068898	TWI4-0719-EMSC
4068748	TWI4-0723-DM
4068749	TWI4-0726-DM
4068750	TWI4-0729-DM
4068752	TWI4-0732-DM
4068756	TWI4-0734-DM
4068757	TWI4-0739-DM
4068758	TWI4-0744-DM
4068759	TWI4-0749-DM
4068760	TWI4-0754-DM
4068761	TWI4-0759-DM
4068762	TWI4-0764-DM
4068763	TWI4-1203-DM
4068857	TWI4-1203-EM
4068899	TWI4-1203-EMSC
4068764	TWI4-1205-DM
4068858	TWI4-1205-EM
4068900	TWI4-1205-EMSC
4068765	TWI4-1208-DM

Sub TWI-A 4

Article no.	Description
4068859	TWI4-1208-EM
4068901	TWI4-1208-EMSC
4068766	TWI4-1210-DM
4068767	TWI4-1213-DM
4068768	TWI4-1214-DM
4068769	TWI4-1217-DM
4068770	TWI4-1220-DM
4068771	TWI4-1224-DM
4068772	TWI4-1227-DM



TWI4-0206-DM (4067802)

Item	Description	Quantity
1	OTHERS STAGES KIT TWI4-02 PUMP	1
Note: no longer available / nicht mehr lieferbar / ne plus disponible		
1.1	> DIFFUSER WITH RETURN GUIDE VANE	1
1.2	> PUMP IS 2 IMPELLER	1
1.3	> INTERMEDIATE BEARING	1
1.4	> NECK RING + STAINLESS STEEL PART (AISI)	1
2	STANDARD CASING DISCHARGE TWI4-02 PUMP	1
Note: no longer available / nicht mehr lieferbar / ne plus disponible		
2.1	> DISCHARGE CHAMBER	1
2.2	> BEARING SPACER	1
2.3	> VALVE SEAT AND RETAINER	1
2.4	> VALVE CONE	1
3	SUCTION CASING AND STRAINER KIT TWI PUMP	1
3.1	> SUCTION INTERCONNECTOR	1
3.2	> STRAINER	1



TWI4-0208-DM (4067803)

Item	Description	Quantity
1	OTHERS STAGES KIT TWI4-02 PUMP	1
Note: no longer available / nicht mehr lieferbar / ne plus disponible		
1.1	> DIFFUSER WITH RETURN GUIDE VANE	1
1.2	> PUMP IS 2 IMPELLER	1
1.3	> INTERMEDIATE BEARING	1
1.4	> NECK RING + STAINLESS STEEL PART (AISI)	1
2	STANDARD CASING DISCHARGE TWI4-02 PUMP	1
Note: no longer available / nicht mehr lieferbar / ne plus disponible		
2.1	> DISCHARGE CHAMBER	1
2.2	> BEARING SPACER	1
2.3	> VALVE SEAT AND RETAINER	1
2.4	> VALVE CONE	1
3	SUCTION CASING AND STRAINER KIT TWI PUMP	1
3.1	> SUCTION INTERCONNECTOR	1
3.2	> STRAINER	1

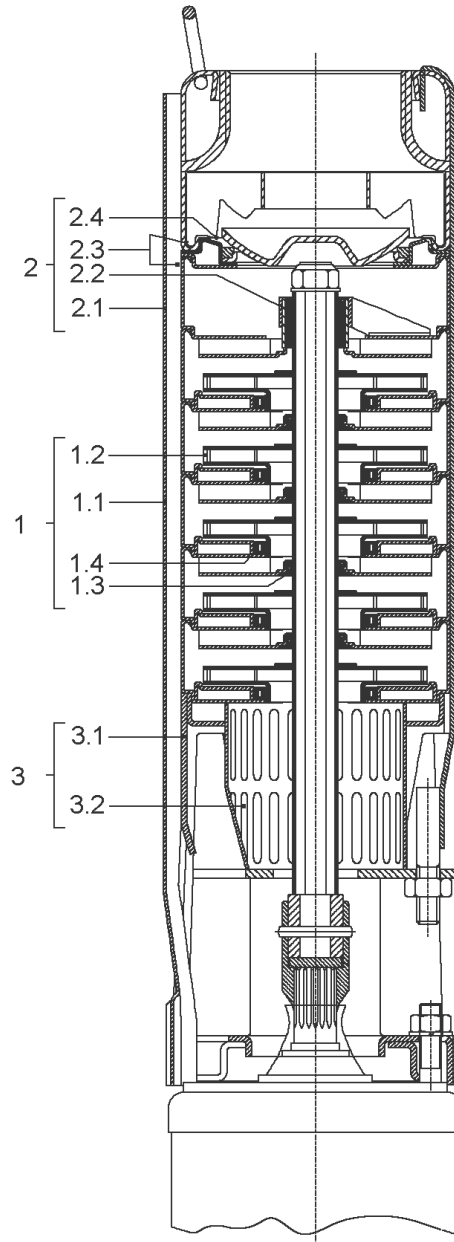

TWI4-0213-DM (4067804)

Item	Description	Quantity
1	OTHERS STAGES KIT TWI4-02 PUMP	1
Note: no longer available / nicht mehrlieferbar / ne plus disponible		
1.1	> DIFFUSER WITH RETURN GUIDE VANE	1
1.2	> PUMP IS 2 IMPELLER	1
1.3	> INTERMEDIATE BEARING	1
1.4	> NECK RING + STAINLESS STEEL PART (AISI)	1
2	STANDARD CASING DISCHARGE TWI4-02 PUMP	1
Note: no longer available / nicht mehrlieferbar / ne plus disponible		
2.1	> DISCHARGE CHAMBER	1
2.2	> BEARING SPACER	1
2.3	> VALVE SEAT AND RETAINER	1
2.4	> VALVE CONE	1
3	SUCTION CASING AND STRAINER KIT TWI PUMP	1
3.1	> SUCTION INTERCONNECTOR	1
3.2	> STRAINER	1

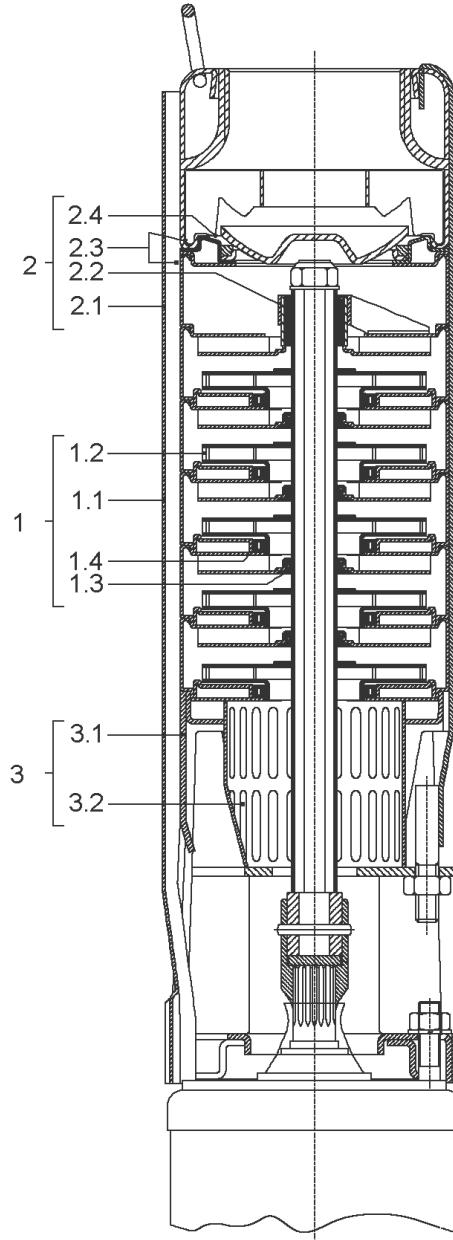

TWI4-0221-DM (4067805)

Item	Description	Quantity
1	OTHERS STAGES KIT TWI4-02 PUMP	1
Note: no longer available / nicht mehrlieferbar / ne plus disponible		
1.1	> DIFFUSER WITH RETURN GUIDE VANE	1
1.2	> PUMP IS 2 IMPELLER	1
1.3	> INTERMEDIATE BEARING	1
1.4	> NECK RING + STAINLESS STEEL PART (AISI)	1
2	STANDARD CASING DISCHARGE TWI4-02 PUMP	1
Note: no longer available / nicht mehrlieferbar / ne plus disponible		
2.1	> DISCHARGE CHAMBER	1
2.2	> BEARING SPACER	1
2.3	> VALVE SEAT AND RETAINER	1
2.4	> VALVE CONE	1
3	SUCTION CASING AND STRAINER KIT TWI PUMP	1
3.1	> SUCTION INTERCONNECTOR	1
3.2	> STRAINER	1

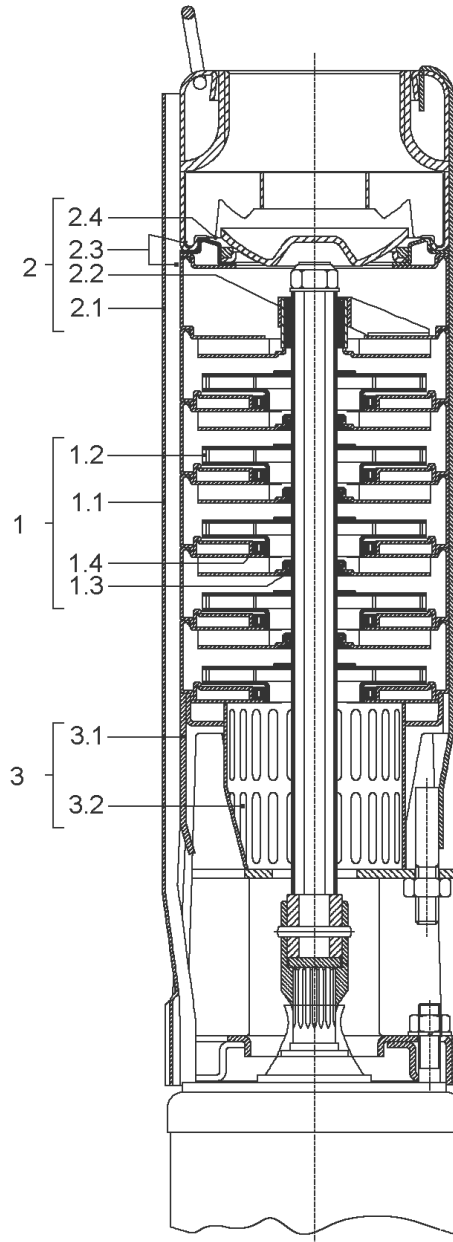

TWI4-0225-DM (4067806)

Item	Description	Quantity
1	OTHERS STAGES KIT TWI4-02 PUMP	1
Note: no longer available / nicht mehr lieferbar / ne plus disponible		
1.1	> DIFFUSER WITH RETURN GUIDE VANE	1
1.2	> PUMP IS 2 IMPELLER	1
1.3	> INTERMEDIATE BEARING	1
1.4	> NECK RING + STAINLESS STEEL PART (AISI)	1
2	STANDARD CASING DISCHARGE TWI4-02 PUMP	1
Note: no longer available / nicht mehr lieferbar / ne plus disponible		
2.1	> DISCHARGE CHAMBER	1
2.2	> BEARING SPACER	1
2.3	> VALVE SEAT AND RETAINER	1
2.4	> VALVE CONE	1
3	SUCTION CASING AND STRAINER KIT TWI PUMP	1
3.1	> SUCTION INTERCONNECTOR	1
3.2	> STRAINER	1



TWI4-0230-DM (4067807)

Item	Description	Quantity
1	OTHERS STAGES KIT TWI4-02 PUMP	1
Note: no longer available / nicht mehr lieferbar / ne plus disponible		
1.1	> DIFFUSER WITH RETURN GUIDE VANE	1
1.2	> PUMP IS 2 IMPELLER	1
1.3	> INTERMEDIATE BEARING	1
1.4	> NECK RING + STAINLESS STEEL PART (AISI)	1
2	STANDARD CASING DISCHARGE TWI4-02 PUMP	1
Note: no longer available / nicht mehr lieferbar / ne plus disponible		
2.1	> DISCHARGE CHAMBER	1
2.2	> BEARING SPACER	1
2.3	> VALVE SEAT AND RETAINER	1
2.4	> VALVE CONE	1
3	SUCTION CASING AND STRAINER KIT TWI PUMP	1
3.1	> SUCTION INTERCONNECTOR	1
3.2	> STRAINER	1

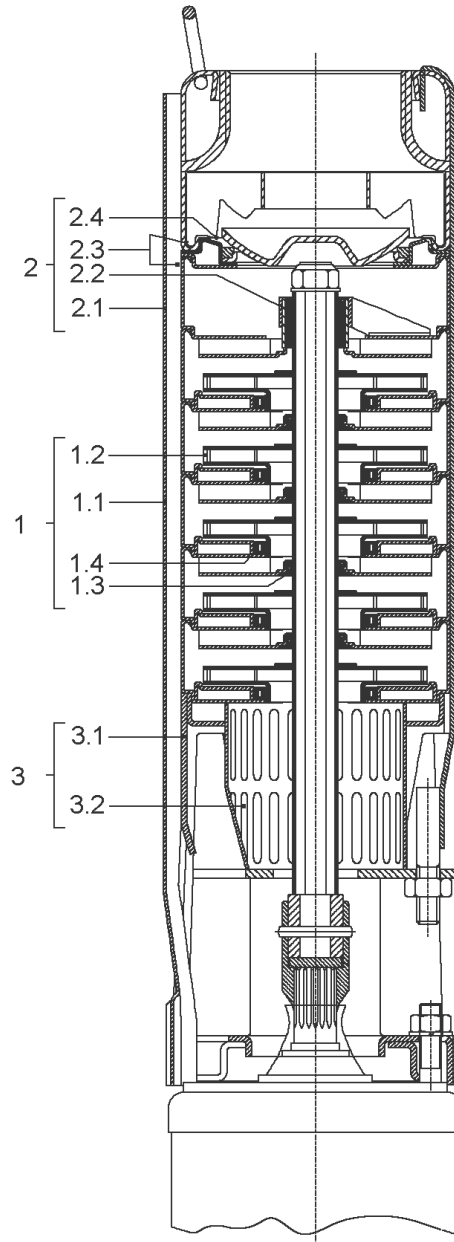

TWI4-0235-DM (4067808)

Item	Description	Quantity
1	OTHERS STAGES KIT TWI4-02 PUMP	1
Note: no longer available / nicht mehrlieferbar / ne plus disponible		
1.1	> DIFFUSER WITH RETURN GUIDE VANE	1
1.2	> PUMP IS 2 IMPELLER	1
1.3	> INTERMEDIATE BEARING	1
1.4	> NECK RING + STAINLESS STEEL PART (AISI)	1
2	STANDARD CASING DISCHARGE TWI4-02 PUMP	1
Note: no longer available / nicht mehrlieferbar / ne plus disponible		
2.1	> DISCHARGE CHAMBER	1
2.2	> BEARING SPACER	1
2.3	> VALVE SEAT AND RETAINER	1
2.4	> VALVE CONE	1
3	SUCTION CASING AND STRAINER KIT TWI PUMP	1
3.1	> SUCTION INTERCONNECTOR	1
3.2	> STRAINER	1

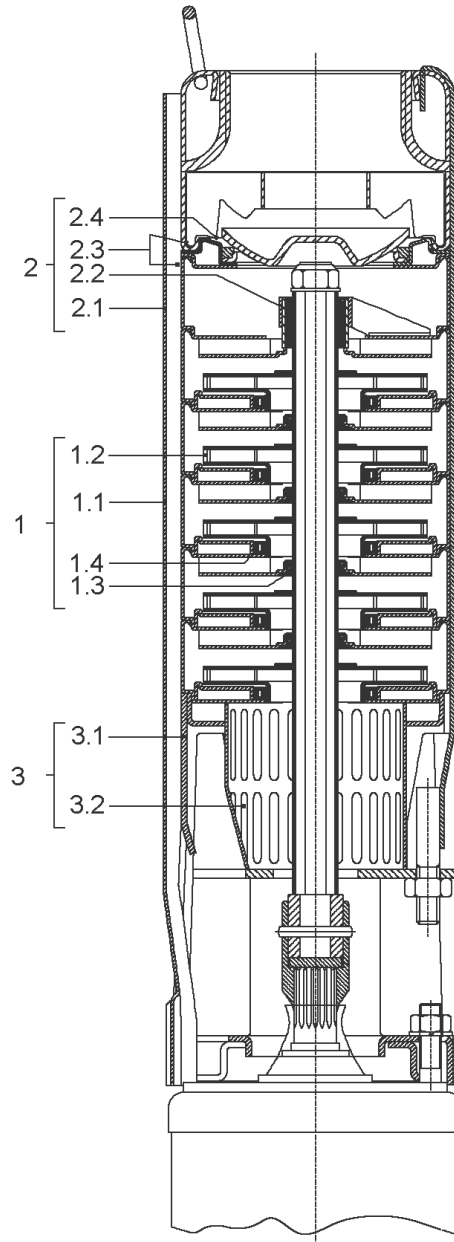

TWI4-0240-DM (4067809)

Item	Description	Quantity
1	OTHERS STAGES KIT TWI4-02 PUMP	1
Note: no longer available / nicht mehr lieferbar / ne plus disponible		
1.1	> DIFFUSER WITH RETURN GUIDE VANE	1
1.2	> PUMP IS 2 IMPELLER	1
1.3	> INTERMEDIATE BEARING	1
1.4	> NECK RING + STAINLESS STEEL PART (AISI)	1
2	STANDARD CASING DISCHARGE TWI4-02 PUMP	1
Note: no longer available / nicht mehr lieferbar / ne plus disponible		
2.1	> DISCHARGE CHAMBER	1
2.2	> BEARING SPACER	1
2.3	> VALVE SEAT AND RETAINER	1
2.4	> VALVE CONE	1
3	SUCTION CASING AND STRAINER KIT TWI PUMP	1
3.1	> SUCTION INTERCONNECTOR	1
3.2	> STRAINER	1



TWI4-0247-DM (4067810)

Item	Description	Quantity
1	OTHERS STAGES KIT TWI4-02 PUMP	1
Note: no longer available / nicht mehrlieferbar / ne plus disponible		
1.1	> DIFFUSER WITH RETURN GUIDE VANE	1
1.2	> PUMP IS 2 IMPELLER	1
1.3	> INTERMEDIATE BEARING	1
1.4	> NECK RING + STAINLESS STEEL PART (AISI)	1
2	STANDARD CASING DISCHARGE TWI4-02 PUMP	1
Note: no longer available / nicht mehrlieferbar / ne plus disponible		
2.1	> DISCHARGE CHAMBER	1
2.2	> BEARING SPACER	1
2.3	> VALVE SEAT AND RETAINER	1
2.4	> VALVE CONE	1
3	SUCTION CASING AND STRAINER KIT TWI PUMP	1
3.1	> SUCTION INTERCONNECTOR	1
3.2	> STRAINER	1



TWI4-0254-DM (4067811)

Item	Description	Quantity
1	OTHERS STAGES KIT TWI4-02 PUMP	1
Note: no longer available / nicht mehrlieferbar / ne plus disponible		
1.1	> DIFFUSER WITH RETURN GUIDE VANE	1
1.2	> PUMP IS 2 IMPELLER	1
1.3	> INTERMEDIATE BEARING	1
1.4	> NECK RING + STAINLESS STEEL PART (AISI)	1
2	STANDARD CASING DISCHARGE TWI4-02 PUMP	1
Note: no longer available / nicht mehrlieferbar / ne plus disponible		
2.1	> DISCHARGE CHAMBER	1
2.2	> BEARING SPACER	1
2.3	> VALVE SEAT AND RETAINER	1
2.4	> VALVE CONE	1
3	SUCTION CASING AND STRAINER KIT TWI PUMP	1
3.1	> SUCTION INTERCONNECTOR	1
3.2	> STRAINER	1

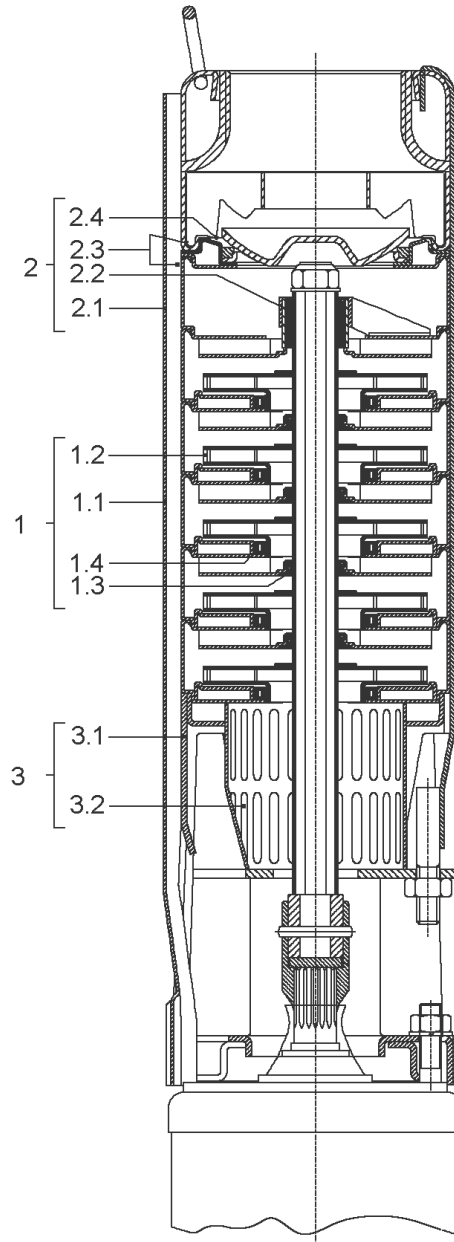

TWI4-0260-DM (4067812)

Item	Description	Quantity
1	OTHERS STAGES KIT TWI4-02 PUMP	1
Note: no longer available / nicht mehrlieferbar / ne plus disponible		
1.1	> DIFFUSER WITH RETURN GUIDE VANE	1
1.2	> PUMP IS 2 IMPELLER	1
1.3	> INTERMEDIATE BEARING	1
1.4	> NECK RING + STAINLESS STEEL PART (AISI)	1
2	SEVERE DUTY DISCHARGE KIT TWI4-02 PUMP	1
Note: no longer available / nicht mehrlieferbar / ne plus disponible		
2.1	> SEVERE DUTY DISCHARGE CHAMBER	1
2.2	> BEARING SPACER	1
3	SUCTION CASING AND STRAINER KIT TWI PUMP	1
3.1	> SUCTION INTERCONNECTOR	1
3.2	> STRAINER	1

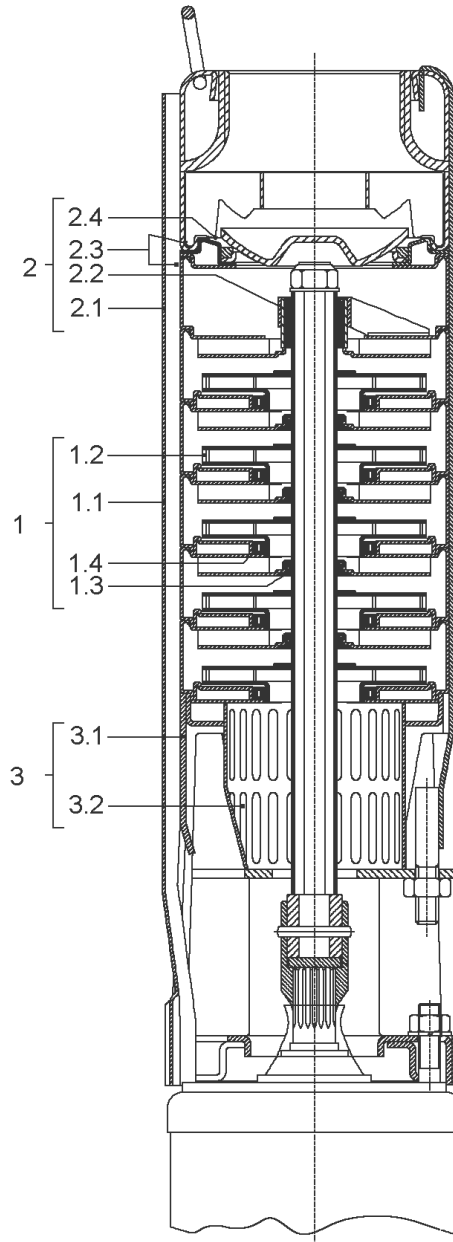

TWI4-0266-DM (4068711)

Item	Description	Quantity
1	OTHERS STAGES KIT TWI4-02 PUMP	1
Note: no longer available / nicht mehrlieferbar / ne plus disponible		
1.1	> DIFFUSER WITH RETURN GUIDE VANE	1
1.2	> PUMP IS 2 IMPELLER	1
1.3	> INTERMEDIATE BEARING	1
1.4	> NECK RING + STAINLESS STEEL PART (AISI)	1
2	SEVERE DUTY DISCHARGE KIT TWI4-02 PUMP	1
Note: no longer available / nicht mehrlieferbar / ne plus disponible		
2.1	> SEVERE DUTY DISCHARGE CHAMBER	1
2.2	> BEARING SPACER	1
3	SUCTION CASING AND STRAINER KIT TWI PUMP	1
3.1	> SUCTION INTERCONNECTOR	1
3.2	> STRAINER	1

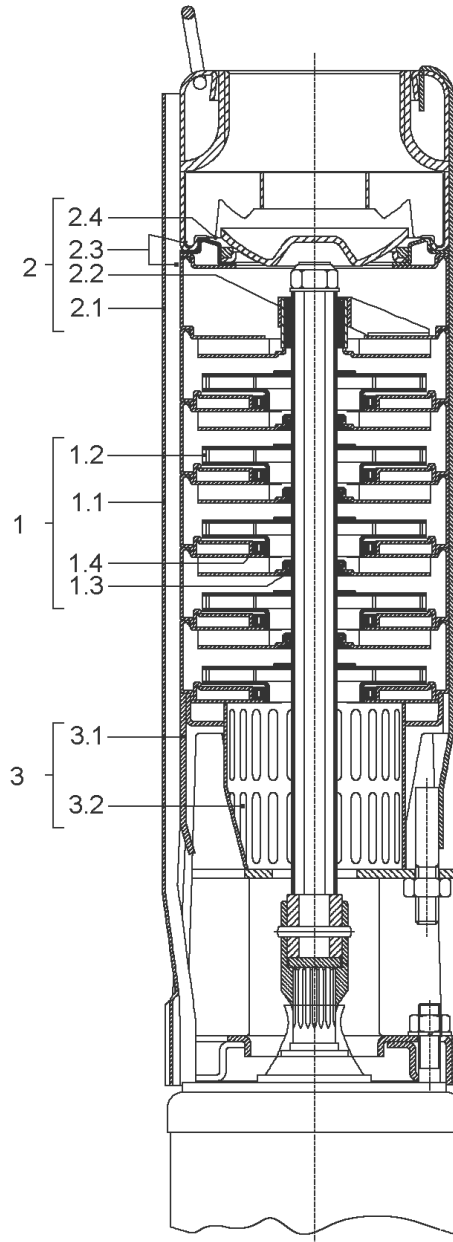

TWI4-0272-DM (4068712)

Item	Description	Quantity
1	OTHERS STAGES KIT TWI4-02 PUMP	1
Note: no longer available / nicht mehrlieferbar / ne plus disponible		
1.1	> DIFFUSER WITH RETURN GUIDE VANE	1
1.2	> PUMP IS 2 IMPELLER	1
1.3	> INTERMEDIATE BEARING	1
1.4	> NECK RING + STAINLESS STEEL PART (AISI)	1
2	SEVERE DUTY DISCHARGE KIT TWI4-02 PUMP	1
Note: no longer available / nicht mehrlieferbar / ne plus disponible		
2.1	> SEVERE DUTY DISCHARGE CHAMBER	1
2.2	> BEARING SPACER	1
3	SUCTION CASING AND STRAINER KIT TWI PUMP	1
3.1	> SUCTION INTERCONNECTOR	1
3.2	> STRAINER	1



TWI4-0306-DM (4068713)

Item	Description	Quantity
1	OTHERS STAGES KIT TWI4-03 PUMP	1
1.1	> DIFFUSER WITH RETURN GUIDE VANE	1
1.2	> PUMP IS 3 IMPELLER	1
1.3	> INTERMEDIATE BEARING	1
1.4	> NECK RING + STAINLESS STEEL PART (AISI)	1
2	STANDARD CASING DISCHARGE TWI4-03 PUMP	1
Note: no longer available / nicht mehr lieferbar / ne plus disponible		
2.1	> DISCHARGE CHAMBER	1
2.2	> BEARING SPACER	1
2.3	> VALVE SEAT AND RETAINER	1
2.4	> VALVE CONE	1
3	SUCTION CASING AND STRAINER KIT TWI PUMP	1
3.1	> SUCTION INTERCONNECTOR	1
3.2	> STRAINER	1

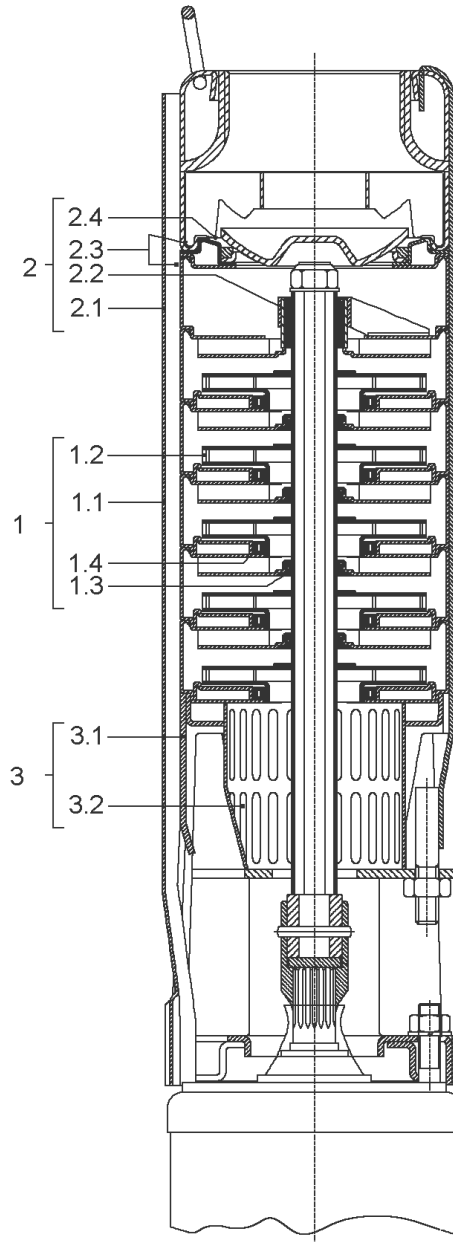

TWI4-0309-DM (4068714)

Item	Description	Quantity
1	OTHERS STAGES KIT TWI4-03 PUMP	1
1.1	> DIFFUSER WITH RETURN GUIDE VANE	1
1.2	> PUMP IS 3 IMPELLER	1
1.3	> INTERMEDIATE BEARING	1
1.4	> NECK RING + STAINLESS STEEL PART (AISI)	1
2	STANDARD CASING DISCHARGE TWI4-03 PUMP	1
Note: no longer available / nicht mehr lieferbar / ne plus disponible		
2.1	> DISCHARGE CHAMBER	1
2.2	> BEARING SPACER	1
2.3	> VALVE SEAT AND RETAINER	1
2.4	> VALVE CONE	1
3	SUCTION CASING AND STRAINER KIT TWI PUMP	1
3.1	> SUCTION INTERCONNECTOR	1
3.2	> STRAINER	1

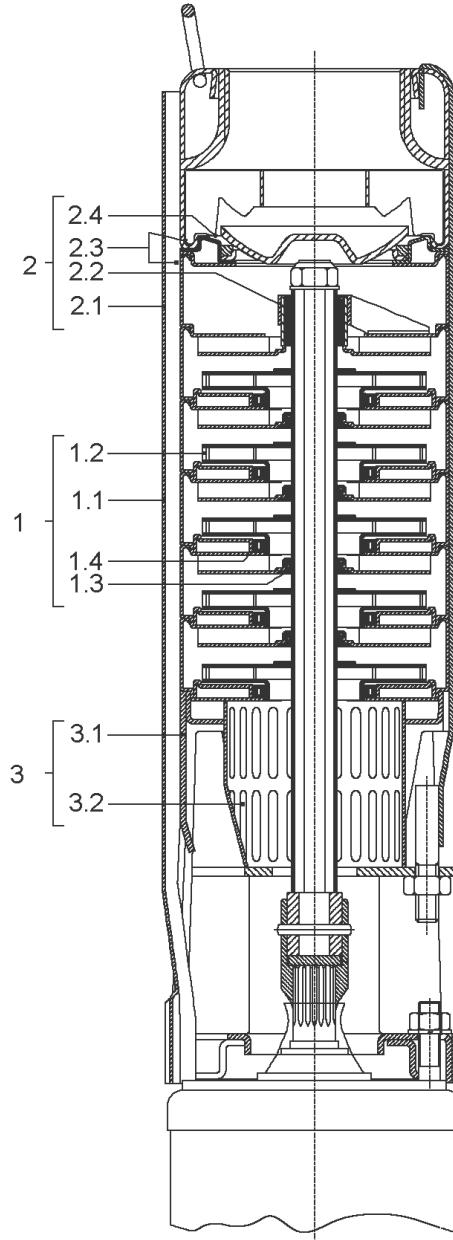

TWI4-0312-DM (4068715)

Item	Description	Quantity
1	OTHERS STAGES KIT TWI4-03 PUMP	1
1.1	> DIFFUSER WITH RETURN GUIDE VANE	1
1.2	> PUMP IS 3 IMPELLER	1
1.3	> INTERMEDIATE BEARING	1
1.4	> NECK RING + STAINLESS STEEL PART (AISI)	1
2	STANDARD CASING DISCHARGE TWI4-03 PUMP	1
Note: no longer available / nicht mehrlieferbar / ne plus disponible		
2.1	> DISCHARGE CHAMBER	1
2.2	> BEARING SPACER	1
2.3	> VALVE SEAT AND RETAINER	1
2.4	> VALVE CONE	1
3	SUCTION CASING AND STRAINER KIT TWI PUMP	1
3.1	> SUCTION INTERCONNECTOR	1
3.2	> STRAINER	1



TWI4-0315-DM (4068716)

Item	Description	Quantity
1	OTHERS STAGES KIT TWI4-03 PUMP	1
1.1	> DIFFUSER WITH RETURN GUIDE VANE	1
1.2	> PUMP IS 3 IMPELLER	1
1.3	> INTERMEDIATE BEARING	1
1.4	> NECK RING + STAINLESS STEEL PART (AISI)	1
2	STANDARD CASING DISCHARGE TWI4-03 PUMP	1
Note: no longer available / nicht mehrlieferbar / ne plus disponible		
2.1	> DISCHARGE CHAMBER	1
2.2	> BEARING SPACER	1
2.3	> VALVE SEAT AND RETAINER	1
2.4	> VALVE CONE	1
3	SUCTION CASING AND STRAINER KIT TWI PUMP	1
3.1	> SUCTION INTERCONNECTOR	1
3.2	> STRAINER	1



TWI4-0318-DM (4068717)

Item	Description	Quantity
1	OTHERS STAGES KIT TWI4-03 PUMP	1
1.1	> DIFFUSER WITH RETURN GUIDE VANE	1
1.2	> PUMP IS 3 IMPELLER	1
1.3	> INTERMEDIATE BEARING	1
1.4	> NECK RING + STAINLESS STEEL PART (AISI)	1
2	STANDARD CASING DISCHARGE TWI4-03 PUMP	1
Note: no longer available / nicht mehr lieferbar / ne plus disponible		
2.1	> DISCHARGE CHAMBER	1
2.2	> BEARING SPACER	1
2.3	> VALVE SEAT AND RETAINER	1
2.4	> VALVE CONE	1
3	SUCTION CASING AND STRAINER KIT TWI PUMP	1
3.1	> SUCTION INTERCONNECTOR	1
3.2	> STRAINER	1

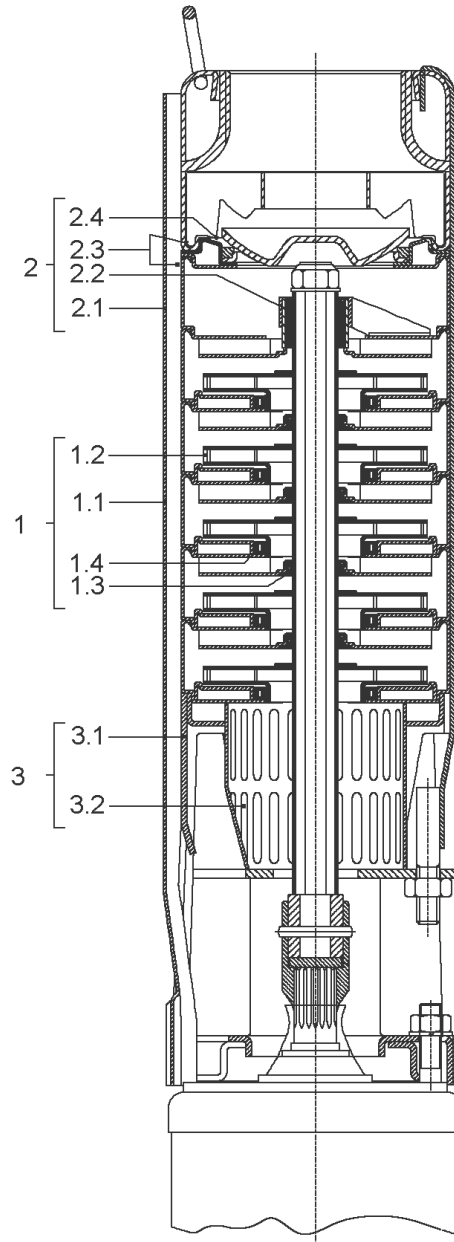

TWI4-0322-DM (4068718)

Item	Description	Quantity
1	OTHERS STAGES KIT TWI4-03 PUMP	1
1.1	> DIFFUSER WITH RETURN GUIDE VANE	1
1.2	> PUMP IS 3 IMPELLER	1
1.3	> INTERMEDIATE BEARING	1
1.4	> NECK RING + STAINLESS STEEL PART (AISI)	1
2	STANDARD CASING DISCHARGE TWI4-03 PUMP	1
Note: no longer available / nicht mehr lieferbar / ne plus disponible		
2.1	> DISCHARGE CHAMBER	1
2.2	> BEARING SPACER	1
2.3	> VALVE SEAT AND RETAINER	1
2.4	> VALVE CONE	1
3	SUCTION CASING AND STRAINER KIT TWI PUMP	1
3.1	> SUCTION INTERCONNECTOR	1
3.2	> STRAINER	1

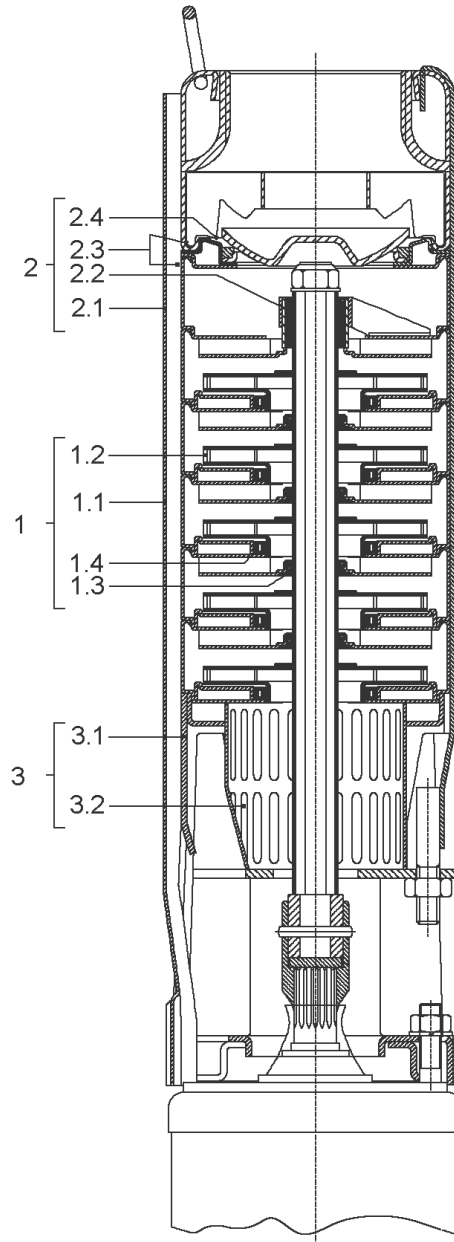

TWI4-0325-DM (4068719)

Item	Description	Quantity
1	OTHERS STAGES KIT TWI4-03 PUMP	1
1.1	> DIFFUSER WITH RETURN GUIDE VANE	1
1.2	> PUMP IS 3 IMPELLER	1
1.3	> INTERMEDIATE BEARING	1
1.4	> NECK RING + STAINLESS STEEL PART (AISI)	1
2	STANDARD CASING DISCHARGE TWI4-03 PUMP	1
Note: no longer available / nicht mehr lieferbar / ne plus disponible		
2.1	> DISCHARGE CHAMBER	1
2.2	> BEARING SPACER	1
2.3	> VALVE SEAT AND RETAINER	1
2.4	> VALVE CONE	1
3	SUCTION CASING AND STRAINER KIT TWI PUMP	1
3.1	> SUCTION INTERCONNECTOR	1
3.2	> STRAINER	1

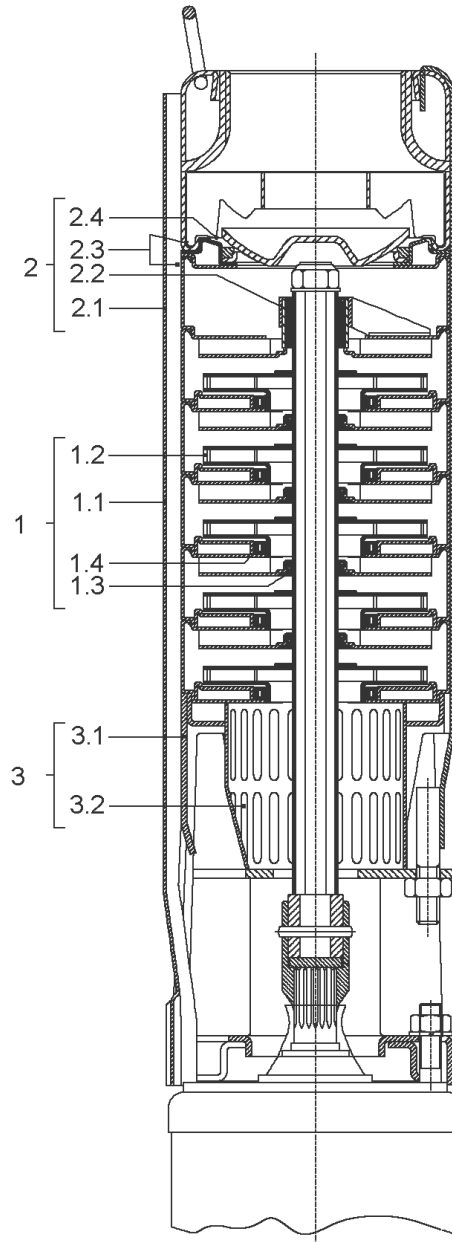

TWI4-0330-DM (4068720)

Item	Description	Quantity
1	OTHERS STAGES KIT TWI4-03 PUMP	1
1.1	> DIFFUSER WITH RETURN GUIDE VANE	1
1.2	> PUMP IS 3 IMPELLER	1
1.3	> INTERMEDIATE BEARING	1
1.4	> NECK RING + STAINLESS STEEL PART (AISI)	1
2	STANDARD CASING DISCHARGE TWI4-03 PUMP	1
Note: no longer available / nicht mehrlieferbar / ne plus disponible		
2.1	> DISCHARGE CHAMBER	1
2.2	> BEARING SPACER	1
2.3	> VALVE SEAT AND RETAINER	1
2.4	> VALVE CONE	1
3	SUCTION CASING AND STRAINER KIT TWI PUMP	1
3.1	> SUCTION INTERCONNECTOR	1
3.2	> STRAINER	1



TWI4-0336-DM (4068721)

Item	Description	Quantity
1	OTHERS STAGES KIT TWI4-03 PUMP	1
1.1	> DIFFUSER WITH RETURN GUIDE VANE	1
1.2	> PUMP IS 3 IMPELLER	1
1.3	> INTERMEDIATE BEARING	1
1.4	> NECK RING + STAINLESS STEEL PART (AISI)	1
2	STANDARD CASING DISCHARGE TWI4-03 PUMP	1
Note: no longer available / nicht mehr lieferbar / ne plus disponible		
2.1	> DISCHARGE CHAMBER	1
2.2	> BEARING SPACER	1
2.3	> VALVE SEAT AND RETAINER	1
2.4	> VALVE CONE	1
3	SUCTION CASING AND STRAINER KIT TWI PUMP	1
3.1	> SUCTION INTERCONNECTOR	1
3.2	> STRAINER	1

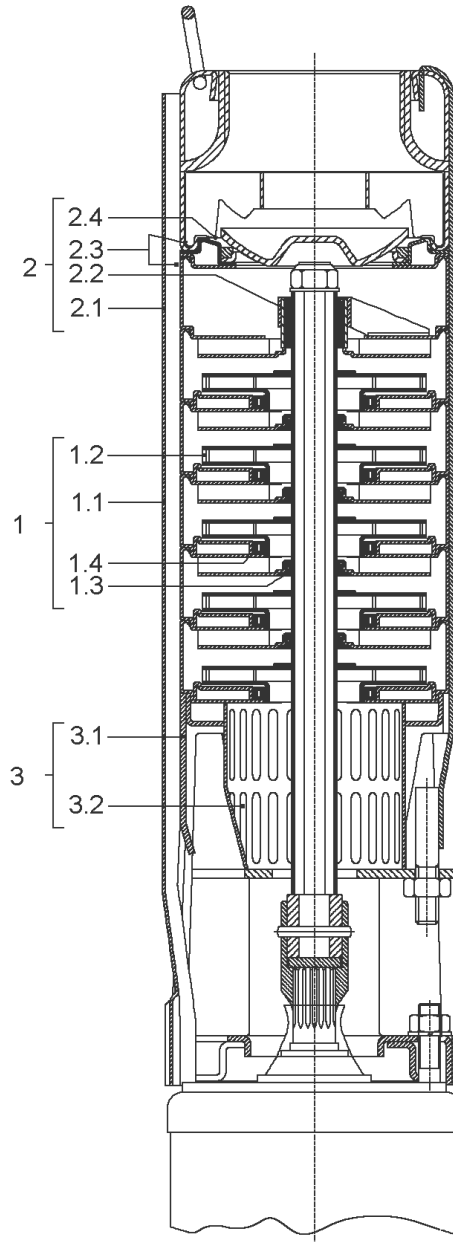

TWI4-0344-DM (4068722)

Item	Description	Quantity
1	OTHERS STAGES KIT TWI4-03 PUMP	1
1.1	> DIFFUSER WITH RETURN GUIDE VANE	1
1.2	> PUMP IS 3 IMPELLER	1
1.3	> INTERMEDIATE BEARING	1
1.4	> NECK RING + STAINLESS STEEL PART (AISI)	1
2	STANDARD CASING DISCHARGE TWI4-03 PUMP	1
Note: no longer available / nicht mehrlieferbar / ne plus disponible		
2.1	> DISCHARGE CHAMBER	1
2.2	> BEARING SPACER	1
2.3	> VALVE SEAT AND RETAINER	1
2.4	> VALVE CONE	1
3	SUCTION CASING AND STRAINER KIT TWI PUMP	1
3.1	> SUCTION INTERCONNECTOR	1
3.2	> STRAINER	1

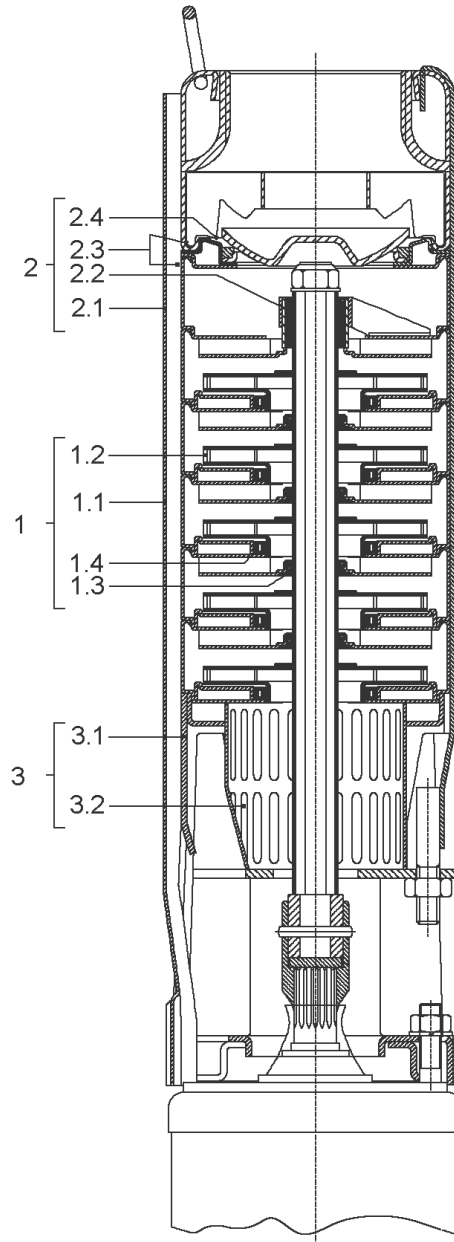

TWI4-0351-DM (4068723)

Item	Description	Quantity
1	OTHERS STAGES KIT TWI4-03 PUMP	1
1.1	> DIFFUSER WITH RETURN GUIDE VANE	1
1.2	> PUMP IS 3 IMPELLER	1
1.3	> INTERMEDIATE BEARING	1
1.4	> NECK RING + STAINLESS STEEL PART (AISI)	1
2	SEVERE DUTY DISCHARGE KIT TWI4-03 PUMP	1
Note: no longer available / nicht mehr lieferbar / ne plus disponible		
2.1	> SEVERE DUTY DISCHARGE CHAMBER	1
2.2	> BEARING SPACER	1
3	SUCTION CASING AND STRAINER KIT TWI PUMP	1
3.1	> SUCTION INTERCONNECTOR	1
3.2	> STRAINER	1



TWI4-0357-DM (4068724)

Item	Description	Quantity
1	OTHERS STAGES KIT TWI4-03 PUMP	1
1.1	> DIFFUSER WITH RETURN GUIDE VANE	1
1.2	> PUMP IS 3 IMPELLER	1
1.3	> INTERMEDIATE BEARING	1
1.4	> NECK RING + STAINLESS STEEL PART (AISI)	1
2	SEVERE DUTY DISCHARGE KIT TWI4-03 PUMP	1
Note: no longer available / nicht mehr lieferbar / ne plus disponible		
2.1	> SEVERE DUTY DISCHARGE CHAMBER	1
2.2	> BEARING SPACER	1
3	SUCTION CASING AND STRAINER KIT TWI PUMP	1
3.1	> SUCTION INTERCONNECTOR	1
3.2	> STRAINER	1



TWI4-0362-DM (4068725)

Item	Description	Quantity
1	OTHERS STAGES KIT TWI4-03 PUMP	1
1.1	> DIFFUSER WITH RETURN GUIDE VANE	1
1.2	> PUMP IS 3 IMPELLER	1
1.3	> INTERMEDIATE BEARING	1
1.4	> NECK RING + STAINLESS STEEL PART (AISI)	1
2	SEVERE DUTY DISCHARGE KIT TWI4-03 PUMP	1
Note: no longer available / nicht mehr lieferbar / ne plus disponible		
2.1	> SEVERE DUTY DISCHARGE CHAMBER	1
2.2	> BEARING SPACER	1
3	SUCTION CASING AND STRAINER KIT TWI PUMP	1
3.1	> SUCTION INTERCONNECTOR	1
3.2	> STRAINER	1

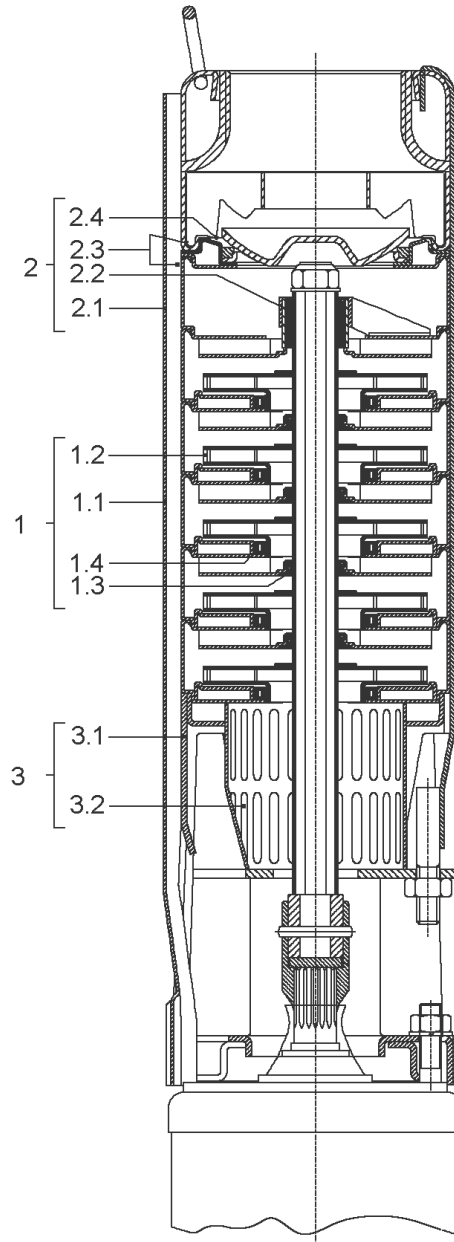

TWI4-0368-DM (4068726)

Item	Description	Quantity
1	OTHERS STAGES KIT TWI4-03 PUMP	1
1.1	> DIFFUSER WITH RETURN GUIDE VANE	1
1.2	> PUMP IS 3 IMPELLER	1
1.3	> INTERMEDIATE BEARING	1
1.4	> NECK RING + STAINLESS STEEL PART (AISI)	1
2	SEVERE DUTY DISCHARGE KIT TWI4-03 PUMP	1
Note: no longer available / nicht mehr lieferbar / ne plus disponible		
2.1	> SEVERE DUTY DISCHARGE CHAMBER	1
2.2	> BEARING SPACER	1
3	SUCTION CASING AND STRAINER KIT TWI PUMP	1
3.1	> SUCTION INTERCONNECTOR	1
3.2	> STRAINER	1

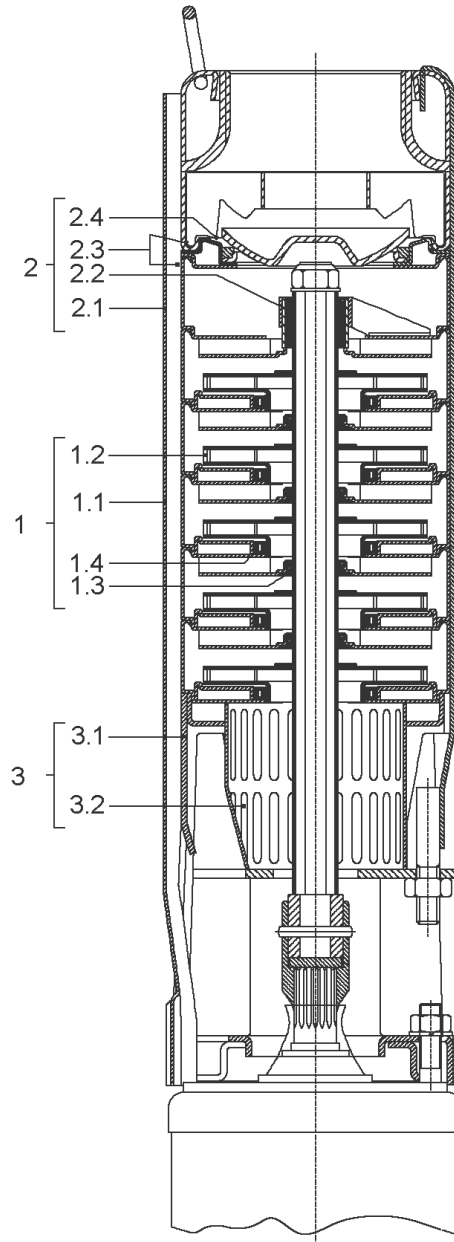

TWI4-0404-DM (4068727)

Item	Description	Quantity
1	OTHERS STAGES KIT TWI4-04 PUMP	1
1.1	> DIFFUSER WITH RETURN GUIDE VANE	1
1.2	> PUMP IS 4 IMPELLER	1
1.3	> INTERMEDIATE BEARING	1
1.4	> NECK RING + STAINLESS STEEL PART (AISI)	1
2	STANDARD CASING DISCHARGE TWI4-04 PUMP	1
2.1	> DISCHARGE CHAMBER	1
2.2	> BEARING SPACER	1
2.3	> VALVE SEAT AND RETAINER	1
2.4	> VALVE CONE	1
3	SUCTION CASING AND STRAINER KIT TWI PUMP	1
3.1	> SUCTION INTERCONNECTOR	1
3.2	> STRAINER	1



TWI4-0407-DM (4068728)

Item	Description	Quantity
1	OTHERS STAGES KIT TWI4-04 PUMP	1
1.1	> DIFFUSER WITH RETURN GUIDE VANE	1
1.2	> PUMP IS 4 IMPELLER	1
1.3	> INTERMEDIATE BEARING	1
1.4	> NECK RING + STAINLESS STEEL PART (AISI)	1
2	STANDARD CASING DISCHARGE TWI4-04 PUMP	1
2.1	> DISCHARGE CHAMBER	1
2.2	> BEARING SPACER	1
2.3	> VALVE SEAT AND RETAINER	1
2.4	> VALVE CONE	1
3	SUCTION CASING AND STRAINER KIT TWI PUMP	1
3.1	> SUCTION INTERCONNECTOR	1
3.2	> STRAINER	1

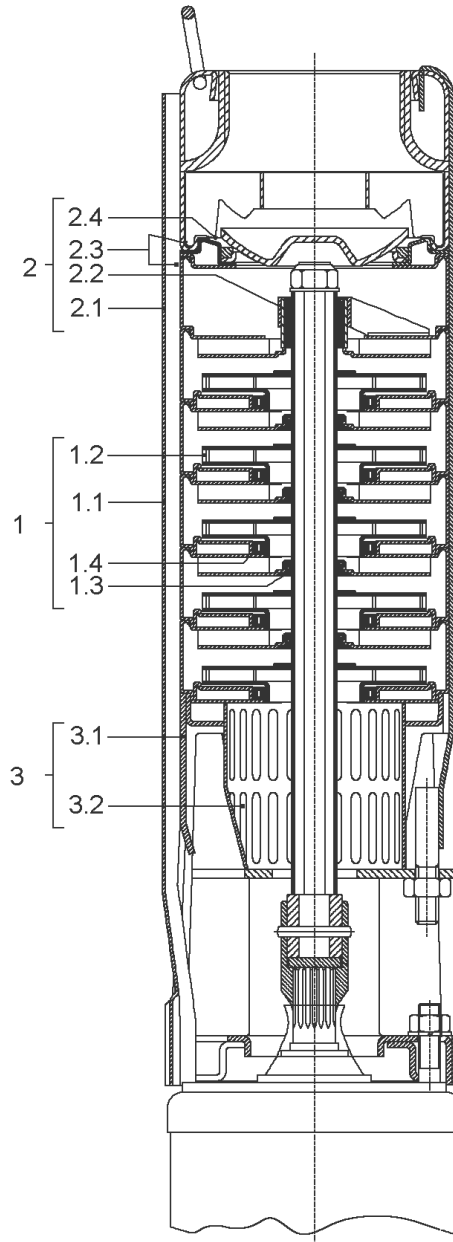

TWI4-0409-DM (4068729)

Item	Description	Quantity
1	OTHERS STAGES KIT TWI4-04 PUMP	1
1.1	> DIFFUSER WITH RETURN GUIDE VANE	1
1.2	> PUMP IS 4 IMPELLER	1
1.3	> INTERMEDIATE BEARING	1
1.4	> NECK RING + STAINLESS STEEL PART (AISI)	1
2	STANDARD CASING DISCHARGE TWI4-04 PUMP	1
2.1	> DISCHARGE CHAMBER	1
2.2	> BEARING SPACER	1
2.3	> VALVE SEAT AND RETAINER	1
2.4	> VALVE CONE	1
3	SUCTION CASING AND STRAINER KIT TWI PUMP	1
3.1	> SUCTION INTERCONNECTOR	1
3.2	> STRAINER	1

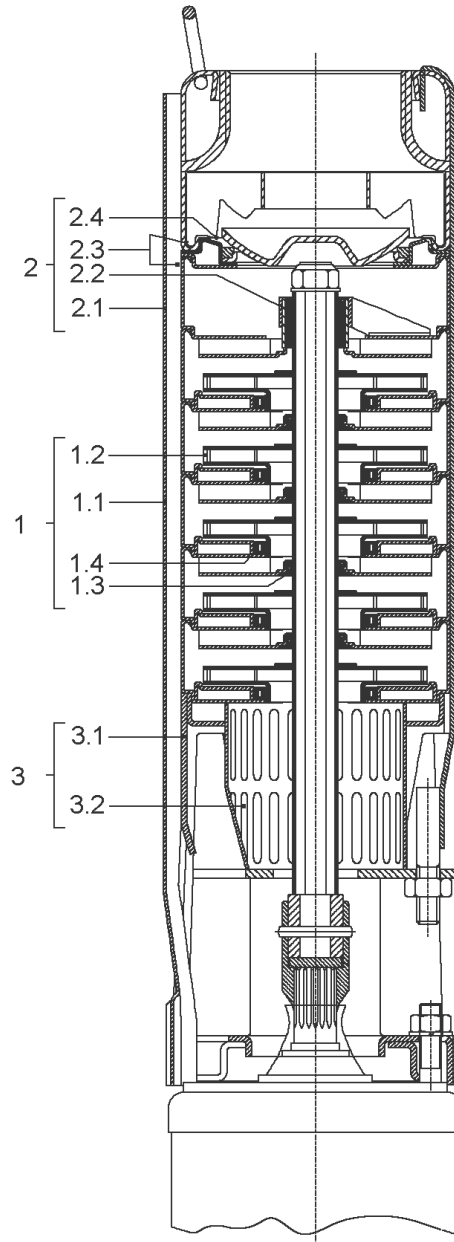

TWI4-0414-DM (4068730)

Item	Description	Quantity
1	OTHERS STAGES KIT TWI4-04 PUMP	1
1.1	> DIFFUSER WITH RETURN GUIDE VANE	1
1.2	> PUMP IS 4 IMPELLER	1
1.3	> INTERMEDIATE BEARING	1
1.4	> NECK RING + STAINLESS STEEL PART (AISI)	1
2	STANDARD CASING DISCHARGE TWI4-04 PUMP	1
2.1	> DISCHARGE CHAMBER	1
2.2	> BEARING SPACER	1
2.3	> VALVE SEAT AND RETAINER	1
2.4	> VALVE CONE	1
3	SUCTION CASING AND STRAINER KIT TWI PUMP	1
3.1	> SUCTION INTERCONNECTOR	1
3.2	> STRAINER	1

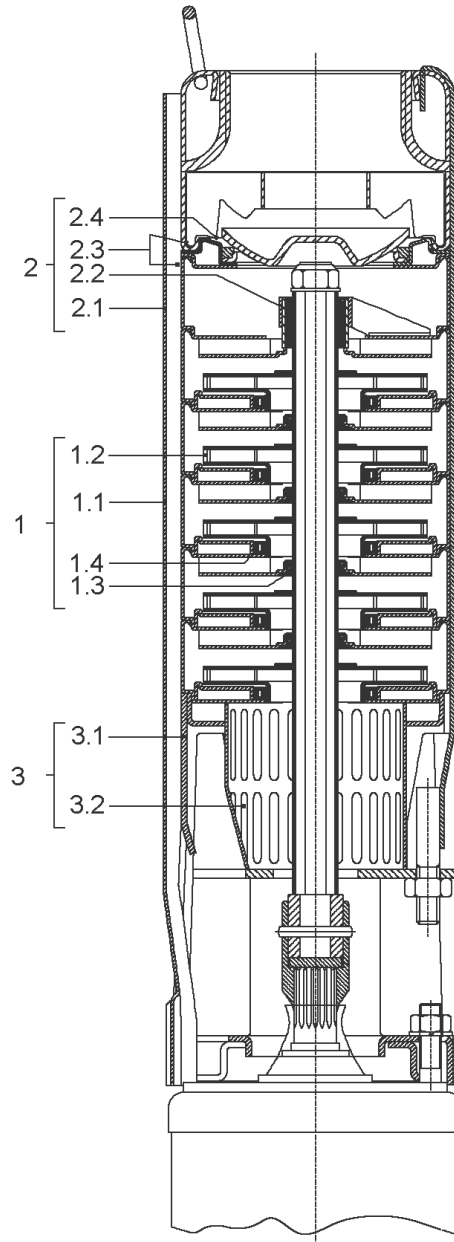

TWI4-0419-DM (4068731)

Item	Description	Quantity
1	OTHERS STAGES KIT TWI4-04 PUMP	1
1.1	> DIFFUSER WITH RETURN GUIDE VANE	1
1.2	> PUMP IS 4 IMPELLER	1
1.3	> INTERMEDIATE BEARING	1
1.4	> NECK RING + STAINLESS STEEL PART (AISI)	1
2	STANDARD CASING DISCHARGE TWI4-04 PUMP	1
2.1	> DISCHARGE CHAMBER	1
2.2	> BEARING SPACER	1
2.3	> VALVE SEAT AND RETAINER	1
2.4	> VALVE CONE	1
3	SUCTION CASING AND STRAINER KIT TWI PUMP	1
3.1	> SUCTION INTERCONNECTOR	1
3.2	> STRAINER	1



TWI4-0424-DM (4068732)

Item	Description	Quantity
1	OTHERS STAGES KIT TWI4-04 PUMP	1
1.1	> DIFFUSER WITH RETURN GUIDE VANE	1
1.2	> PUMP IS 4 IMPELLER	1
1.3	> INTERMEDIATE BEARING	1
1.4	> NECK RING + STAINLESS STEEL PART (AISI)	1
2	STANDARD CASING DISCHARGE TWI4-04 PUMP	1
2.1	> DISCHARGE CHAMBER	1
2.2	> BEARING SPACER	1
2.3	> VALVE SEAT AND RETAINER	1
2.4	> VALVE CONE	1
3	SUCTION CASING AND STRAINER KIT TWI PUMP	1
3.1	> SUCTION INTERCONNECTOR	1
3.2	> STRAINER	1



TWI4-0429-DM (4068733)

Item	Description	Quantity
1	OTHERS STAGES KIT TWI4-04 PUMP	1
1.1	> DIFFUSER WITH RETURN GUIDE VANE	1
1.2	> PUMP IS 4 IMPELLER	1
1.3	> INTERMEDIATE BEARING	1
1.4	> NECK RING + STAINLESS STEEL PART (AISI)	1
2	STANDARD CASING DISCHARGE TWI4-04 PUMP	1
2.1	> DISCHARGE CHAMBER	1
2.2	> BEARING SPACER	1
2.3	> VALVE SEAT AND RETAINER	1
2.4	> VALVE CONE	1
3	SUCTION CASING AND STRAINER KIT TWI PUMP	1
3.1	> SUCTION INTERCONNECTOR	1
3.2	> STRAINER	1

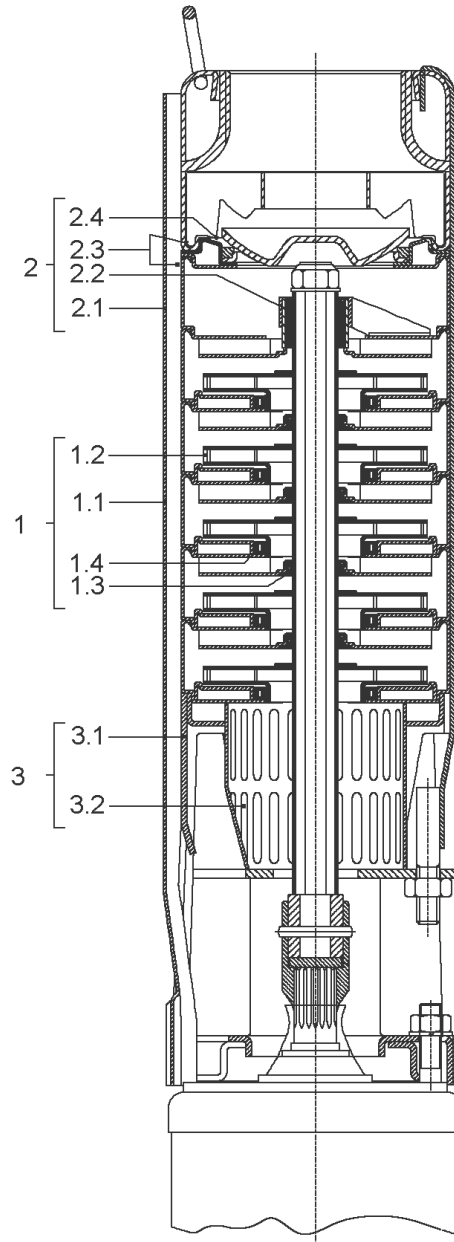

TWI4-0434-DM (4068734)

Item	Description	Quantity
1	OTHERS STAGES KIT TWI4-04 PUMP	1
1.1	> DIFFUSER WITH RETURN GUIDE VANE	1
1.2	> PUMP IS 4 IMPELLER	1
1.3	> INTERMEDIATE BEARING	1
1.4	> NECK RING + STAINLESS STEEL PART (AISI)	1
2	STANDARD CASING DISCHARGE TWI4-04 PUMP	1
2.1	> DISCHARGE CHAMBER	1
2.2	> BEARING SPACER	1
2.3	> VALVE SEAT AND RETAINER	1
2.4	> VALVE CONE	1
3	SUCTION CASING AND STRAINER KIT TWI PUMP	1
3.1	> SUCTION INTERCONNECTOR	1
3.2	> STRAINER	1

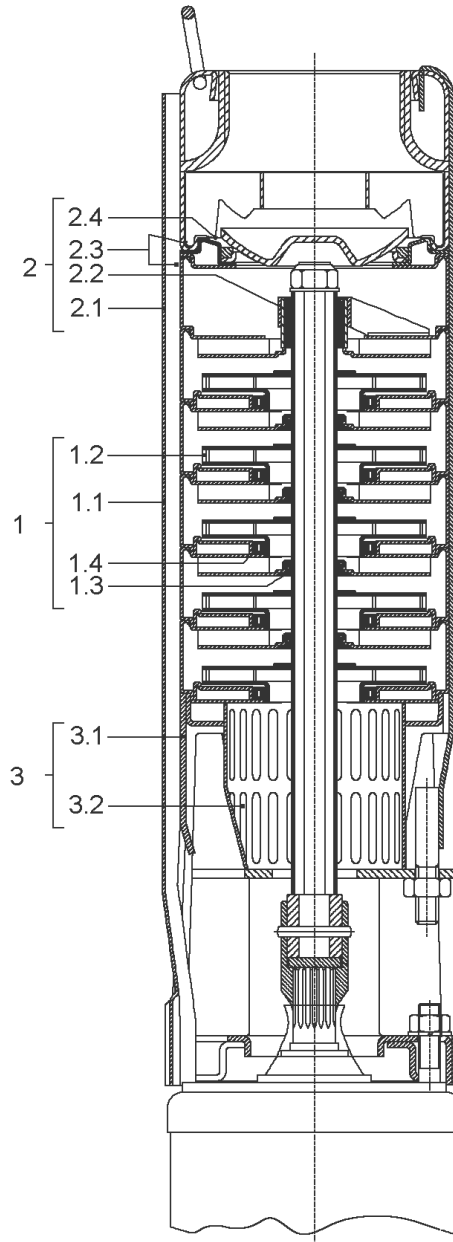

TWI4-0439-DM (4068735)

Item	Description	Quantity
1	OTHERS STAGES KIT TWI4-04 PUMP	1
1.1	> DIFFUSER WITH RETURN GUIDE VANE	1
1.2	> PUMP IS 4 IMPELLER	1
1.3	> INTERMEDIATE BEARING	1
1.4	> NECK RING + STAINLESS STEEL PART (AISI)	1
2	STANDARD CASING DISCHARGE TWI4-04 PUMP	1
2.1	> DISCHARGE CHAMBER	1
2.2	> BEARING SPACER	1
2.3	> VALVE SEAT AND RETAINER	1
2.4	> VALVE CONE	1
3	SUCTION CASING AND STRAINER KIT TWI PUMP	1
3.1	> SUCTION INTERCONNECTOR	1
3.2	> STRAINER	1



TWI4-0445-DM (4068736)

Item	Description	Quantity
1	OTHERS STAGES KIT TWI4-04 PUMP	1
1.1	> DIFFUSER WITH RETURN GUIDE VANE	1
1.2	> PUMP IS 4 IMPELLER	1
1.3	> INTERMEDIATE BEARING	1
1.4	> NECK RING + STAINLESS STEEL PART (AISI)	1
2	STANDARD CASING DISCHARGE TWI4-04 PUMP	1
2.1	> DISCHARGE CHAMBER	1
2.2	> BEARING SPACER	1
2.3	> VALVE SEAT AND RETAINER	1
2.4	> VALVE CONE	1
3	SUCTION CASING AND STRAINER KIT TWI PUMP	1
3.1	> SUCTION INTERCONNECTOR	1
3.2	> STRAINER	1

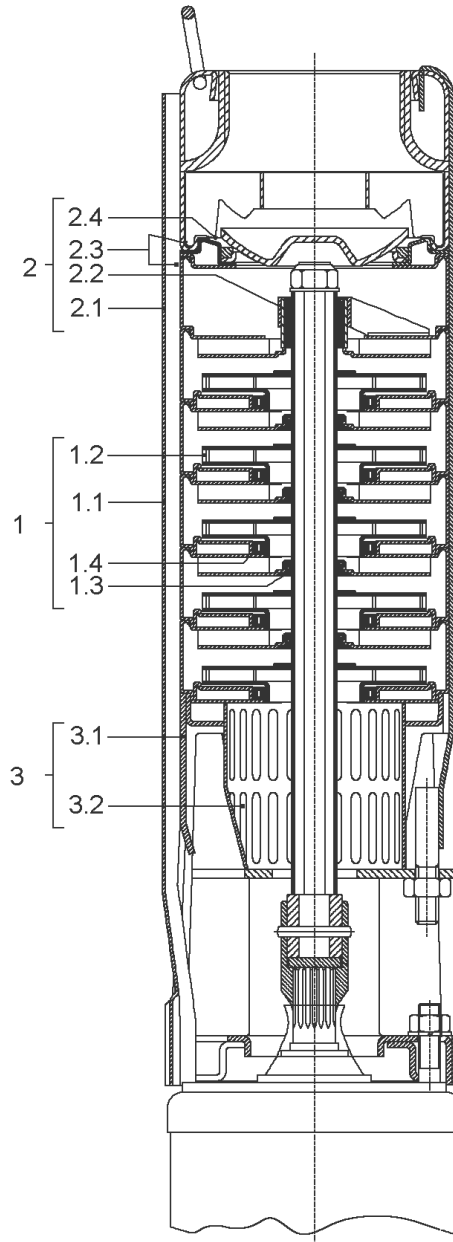

TWI4-0450-DM (4068737)

Item	Description	Quantity
1	OTHERS STAGES KIT TWI4-04 PUMP	1
1.1	> DIFFUSER WITH RETURN GUIDE VANE	1
1.2	> PUMP IS 4 IMPELLER	1
1.3	> INTERMEDIATE BEARING	1
1.4	> NECK RING + STAINLESS STEEL PART (AISI)	1
2	STANDARD CASING DISCHARGE TWI4-04 PUMP	1
2.1	> DISCHARGE CHAMBER	1
2.2	> BEARING SPACER	1
2.3	> VALVE SEAT AND RETAINER	1
2.4	> VALVE CONE	1
3	SUCTION CASING AND STRAINER KIT TWI PUMP	1
3.1	> SUCTION INTERCONNECTOR	1
3.2	> STRAINER	1

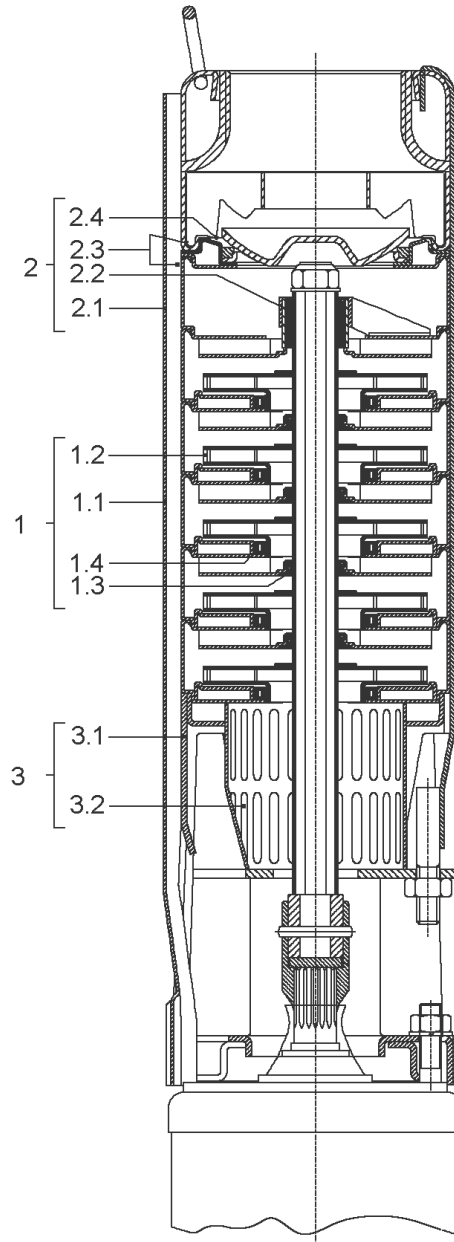

TWI4-0460-DM (4068738)

Item	Description	Quantity
1	OTHERS STAGES KIT TWI4-04 PUMP	1
1.1	> DIFFUSER WITH RETURN GUIDE VANE	1
1.2	> PUMP IS 4 IMPELLER	1
1.3	> INTERMEDIATE BEARING	1
1.4	> NECK RING + STAINLESS STEEL PART (AISI)	1
2	SEVERE DUTY DISCHARGE KIT TWI4-04 PUMP	1
Note: no longer available / nicht mehr lieferbar / ne plus disponible		
2.1	> SEVERE DUTY DISCHARGE CHAMBER	1
2.2	> BEARING SPACER	1
3	SUCTION CASING AND STRAINER KIT TWI PUMP	1
3.1	> SUCTION INTERCONNECTOR	1
3.2	> STRAINER	1

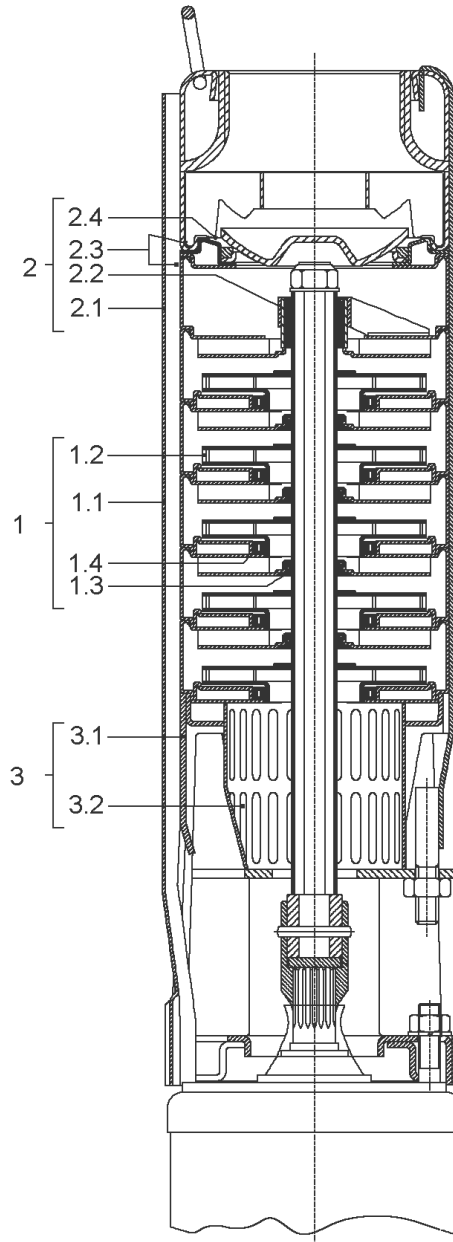

TWI4-0466-DM (4068739)

Item	Description	Quantity
1	OTHERS STAGES KIT TWI4-04 PUMP	1
1.1	> DIFFUSER WITH RETURN GUIDE VANE	1
1.2	> PUMP IS 4 IMPELLER	1
1.3	> INTERMEDIATE BEARING	1
1.4	> NECK RING + STAINLESS STEEL PART (AISI)	1
2	SEVERE DUTY DISCHARGE KIT TWI4-04 PUMP	1
Note: no longer available / nicht mehr lieferbar / ne plus disponible		
2.1	> SEVERE DUTY DISCHARGE CHAMBER	1
2.2	> BEARING SPACER	1
3	SUCTION CASING AND STRAINER KIT TWI PUMP	1
3.1	> SUCTION INTERCONNECTOR	1
3.2	> STRAINER	1



TWI4-0472-DM (4068740)

Item	Description	Quantity
1	OTHERS STAGES KIT TWI4-04 PUMP	1
1.1	> DIFFUSER WITH RETURN GUIDE VANE	1
1.2	> PUMP IS 4 IMPELLER	1
1.3	> INTERMEDIATE BEARING	1
1.4	> NECK RING + STAINLESS STEEL PART (AISI)	1
2	SEVERE DUTY DISCHARGE KIT TWI4-04 PUMP	1
Note: no longer available / nicht mehr lieferbar / ne plus disponible		
2.1	> SEVERE DUTY DISCHARGE CHAMBER	1
2.2	> BEARING SPACER	1
3	SUCTION CASING AND STRAINER KIT TWI PUMP	1
3.1	> SUCTION INTERCONNECTOR	1
3.2	> STRAINER	1



TWI4-0703-DM (4068741)

Item	Description	Quantity
1	OTHERS STAGES KIT TWI4-07 PUMP	1
1.1	> DIFFUSER WITH RETURN GUIDE VANE	1
1.2	> PUMP IS 7 IMPELLER	1
1.3	> INTERMEDIATE BEARING	1
1.4	> NECK RING + STAINLESS STEEL PART (AISI)	1
2	STANDARD CASING DISCHARGE TWI4-07 PUMP	1
2.1	> DISCHARGE CHAMBER	1
2.2	> BEARING SPACER	1
2.3	> VALVE SEAT AND RETAINER	1
2.4	> VALVE CONE	1
3	SUCTION CASING AND STRAINER KIT TWI PUMP	1
3.1	> SUCTION INTERCONNECTOR	1
3.2	> STRAINER	1

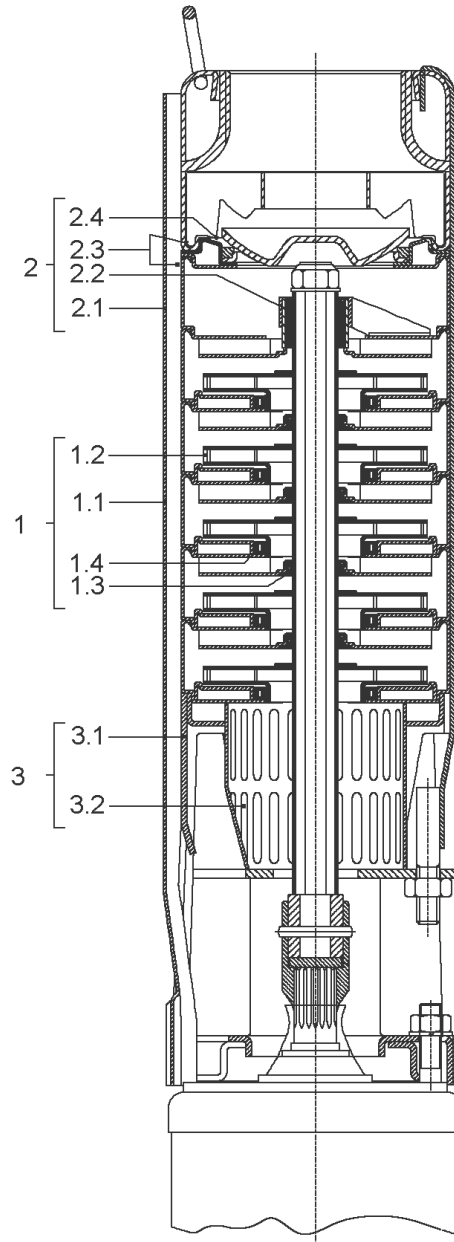

TWI4-0704-DM (4068742)

Item	Description	Quantity
1	OTHERS STAGES KIT TWI4-07 PUMP	1
1.1	> DIFFUSER WITH RETURN GUIDE VANE	1
1.2	> PUMP IS 7 IMPELLER	1
1.3	> INTERMEDIATE BEARING	1
1.4	> NECK RING + STAINLESS STEEL PART (AISI)	1
2	STANDARD CASING DISCHARGE TWI4-07 PUMP	1
2.1	> DISCHARGE CHAMBER	1
2.2	> BEARING SPACER	1
2.3	> VALVE SEAT AND RETAINER	1
2.4	> VALVE CONE	1
3	SUCTION CASING AND STRAINER KIT TWI PUMP	1
3.1	> SUCTION INTERCONNECTOR	1
3.2	> STRAINER	1

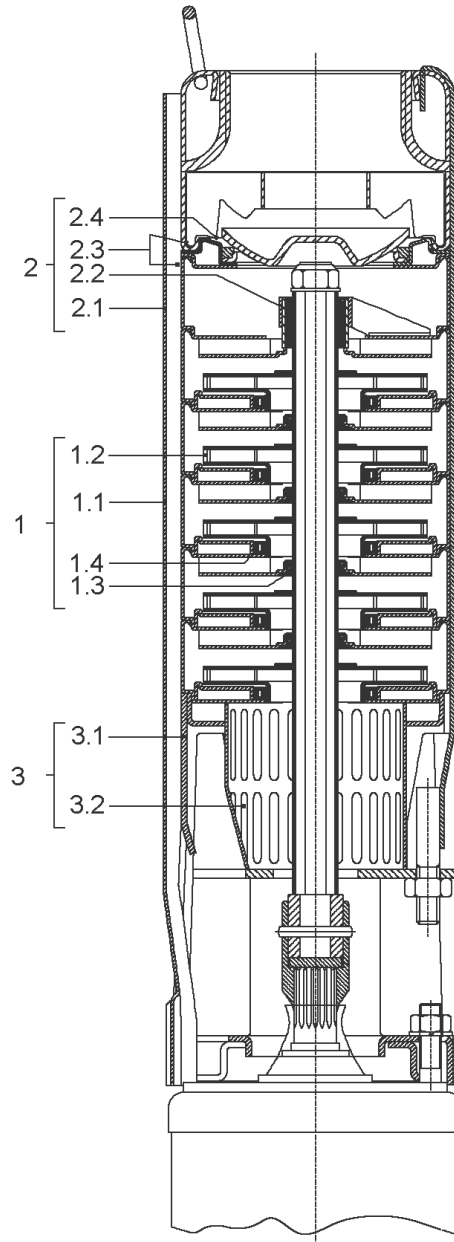

TWI4-0706-DM (4068743)

Item	Description	Quantity
1	OTHERS STAGES KIT TWI4-07 PUMP	1
1.1	> DIFFUSER WITH RETURN GUIDE VANE	1
1.2	> PUMP IS 7 IMPELLER	1
1.3	> INTERMEDIATE BEARING	1
1.4	> NECK RING + STAINLESS STEEL PART (AISI)	1
2	STANDARD CASING DISCHARGE TWI4-07 PUMP	1
2.1	> DISCHARGE CHAMBER	1
2.2	> BEARING SPACER	1
2.3	> VALVE SEAT AND RETAINER	1
2.4	> VALVE CONE	1
3	SUCTION CASING AND STRAINER KIT TWI PUMP	1
3.1	> SUCTION INTERCONNECTOR	1
3.2	> STRAINER	1



TWI4-0709-DM (4068744)

Item	Description	Quantity
1	OTHERS STAGES KIT TWI4-07 PUMP	1
1.1	> DIFFUSER WITH RETURN GUIDE VANE	1
1.2	> PUMP IS 7 IMPELLER	1
1.3	> INTERMEDIATE BEARING	1
1.4	> NECK RING + STAINLESS STEEL PART (AISI)	1
2	STANDARD CASING DISCHARGE TWI4-07 PUMP	1
2.1	> DISCHARGE CHAMBER	1
2.2	> BEARING SPACER	1
2.3	> VALVE SEAT AND RETAINER	1
2.4	> VALVE CONE	1
3	SUCTION CASING AND STRAINER KIT TWI PUMP	1
3.1	> SUCTION INTERCONNECTOR	1
3.2	> STRAINER	1



TWI4-0713-DM (4068745)

Item	Description	Quantity
1	OTHERS STAGES KIT TWI4-07 PUMP	1
1.1	> DIFFUSER WITH RETURN GUIDE VANE	1
1.2	> PUMP IS 7 IMPELLER	1
1.3	> INTERMEDIATE BEARING	1
1.4	> NECK RING + STAINLESS STEEL PART (AISI)	1
2	STANDARD CASING DISCHARGE TWI4-07 PUMP	1
2.1	> DISCHARGE CHAMBER	1
2.2	> BEARING SPACER	1
2.3	> VALVE SEAT AND RETAINER	1
2.4	> VALVE CONE	1
3	SUCTION CASING AND STRAINER KIT TWI PUMP	1
3.1	> SUCTION INTERCONNECTOR	1
3.2	> STRAINER	1

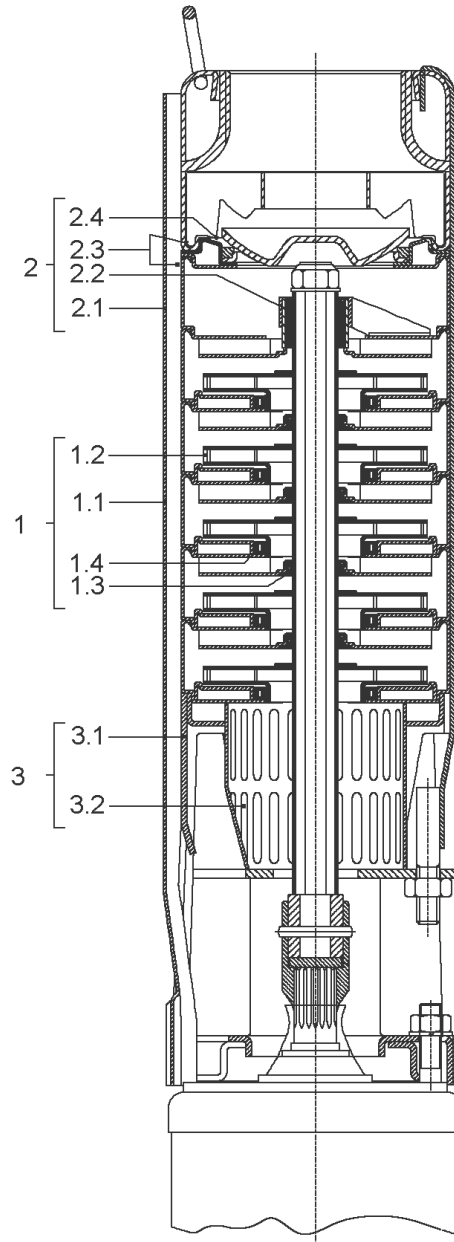

TWI4-0716-DM (4068746)

Item	Description	Quantity
1	OTHERS STAGES KIT TWI4-07 PUMP	1
1.1	> DIFFUSER WITH RETURN GUIDE VANE	1
1.2	> PUMP IS 7 IMPELLER	1
1.3	> INTERMEDIATE BEARING	1
1.4	> NECK RING + STAINLESS STEEL PART (AISI)	1
2	STANDARD CASING DISCHARGE TWI4-07 PUMP	1
2.1	> DISCHARGE CHAMBER	1
2.2	> BEARING SPACER	1
2.3	> VALVE SEAT AND RETAINER	1
2.4	> VALVE CONE	1
3	SUCTION CASING AND STRAINER KIT TWI PUMP	1
3.1	> SUCTION INTERCONNECTOR	1
3.2	> STRAINER	1

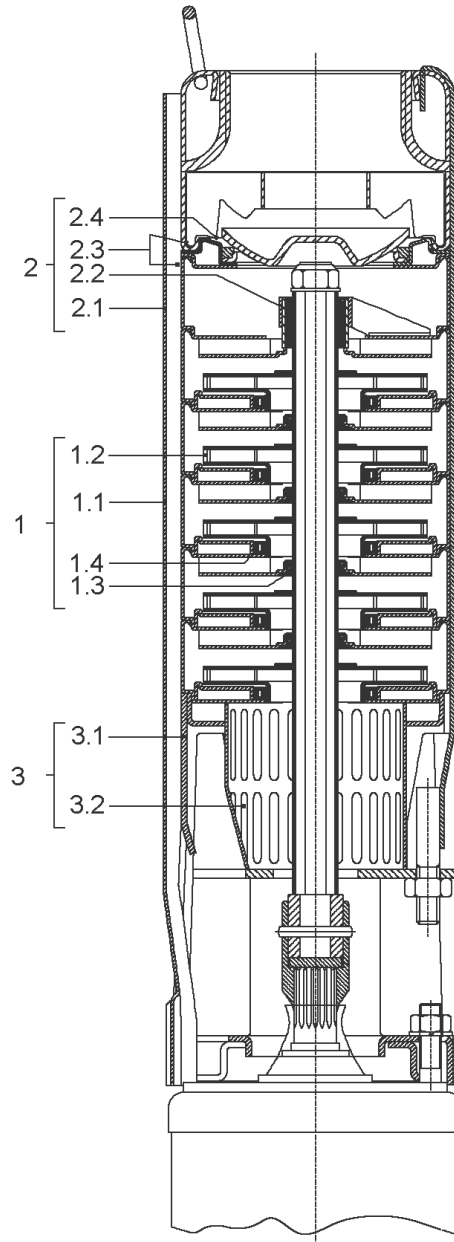

TWI4-0719-DM (4068747)

Item	Description	Quantity
1	OTHERS STAGES KIT TWI4-07 PUMP	1
1.1	> DIFFUSER WITH RETURN GUIDE VANE	1
1.2	> PUMP IS 7 IMPELLER	1
1.3	> INTERMEDIATE BEARING	1
1.4	> NECK RING + STAINLESS STEEL PART (AISI)	1
2	STANDARD CASING DISCHARGE TWI4-07 PUMP	1
2.1	> DISCHARGE CHAMBER	1
2.2	> BEARING SPACER	1
2.3	> VALVE SEAT AND RETAINER	1
2.4	> VALVE CONE	1
3	SUCTION CASING AND STRAINER KIT TWI PUMP	1
3.1	> SUCTION INTERCONNECTOR	1
3.2	> STRAINER	1



TWI4-0723-DM (4068748)

Item	Description	Quantity
1	OTHERS STAGES KIT TWI4-07 PUMP	1
1.1	> DIFFUSER WITH RETURN GUIDE VANE	1
1.2	> PUMP IS 7 IMPELLER	1
1.3	> INTERMEDIATE BEARING	1
1.4	> NECK RING + STAINLESS STEEL PART (AISI)	1
2	STANDARD CASING DISCHARGE TWI4-07 PUMP	1
2.1	> DISCHARGE CHAMBER	1
2.2	> BEARING SPACER	1
2.3	> VALVE SEAT AND RETAINER	1
2.4	> VALVE CONE	1
3	SUCTION CASING AND STRAINER KIT TWI PUMP	1
3.1	> SUCTION INTERCONNECTOR	1
3.2	> STRAINER	1



TWI4-0726-DM (4068749)

Item	Description	Quantity
1	OTHERS STAGES KIT TWI4-07 PUMP	1
1.1	> DIFFUSER WITH RETURN GUIDE VANE	1
1.2	> PUMP IS 7 IMPELLER	1
1.3	> INTERMEDIATE BEARING	1
1.4	> NECK RING + STAINLESS STEEL PART (AISI)	1
2	STANDARD CASING DISCHARGE TWI4-07 PUMP	1
2.1	> DISCHARGE CHAMBER	1
2.2	> BEARING SPACER	1
2.3	> VALVE SEAT AND RETAINER	1
2.4	> VALVE CONE	1
3	SUCTION CASING AND STRAINER KIT TWI PUMP	1
3.1	> SUCTION INTERCONNECTOR	1
3.2	> STRAINER	1

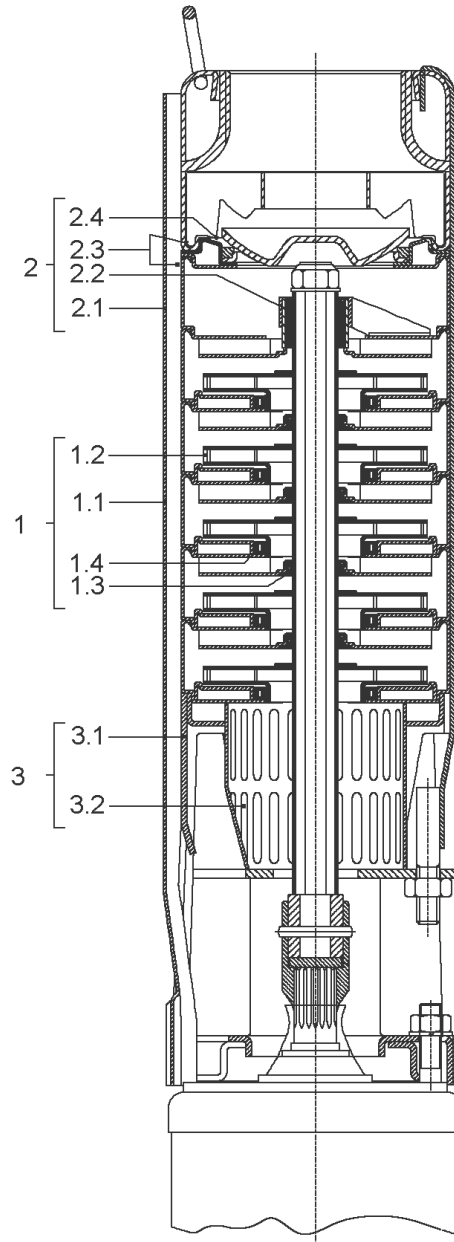

TWI4-0729-DM (4068750)

Item	Description	Quantity
1	OTHERS STAGES KIT TWI4-07 PUMP	1
1.1	> DIFFUSER WITH RETURN GUIDE VANE	1
1.2	> PUMP IS 7 IMPELLER	1
1.3	> INTERMEDIATE BEARING	1
1.4	> NECK RING + STAINLESS STEEL PART (AISI)	1
2	STANDARD CASING DISCHARGE TWI4-07 PUMP	1
2.1	> DISCHARGE CHAMBER	1
2.2	> BEARING SPACER	1
2.3	> VALVE SEAT AND RETAINER	1
2.4	> VALVE CONE	1
3	SUCTION CASING AND STRAINER KIT TWI PUMP	1
3.1	> SUCTION INTERCONNECTOR	1
3.2	> STRAINER	1

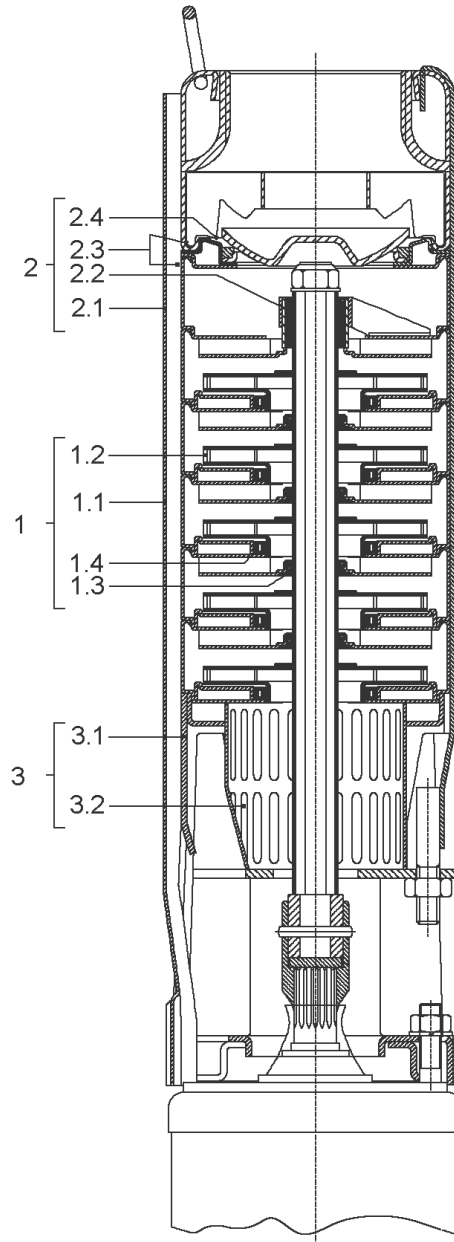

TWI4-0732-DM (4068752)

Item	Description	Quantity
1	OTHERS STAGES KIT TWI4-07 PUMP	1
1.1	> DIFFUSER WITH RETURN GUIDE VANE	1
1.2	> PUMP IS 7 IMPELLER	1
1.3	> INTERMEDIATE BEARING	1
1.4	> NECK RING + STAINLESS STEEL PART (AISI)	1
2	STANDARD CASING DISCHARGE TWI4-07 PUMP	1
2.1	> DISCHARGE CHAMBER	1
2.2	> BEARING SPACER	1
2.3	> VALVE SEAT AND RETAINER	1
2.4	> VALVE CONE	1
3	SUCTION CASING AND STRAINER KIT TWI PUMP	1
3.1	> SUCTION INTERCONNECTOR	1
3.2	> STRAINER	1



TWI4-0734-DM (4068756)

Item	Description	Quantity
1	OTHERS STAGES KIT TWI4-07 PUMP	1
1.1	> DIFFUSER WITH RETURN GUIDE VANE	1
1.2	> PUMP IS 7 IMPELLER	1
1.3	> INTERMEDIATE BEARING	1
1.4	> NECK RING + STAINLESS STEEL PART (AISI)	1
2	STANDARD CASING DISCHARGE TWI4-07 PUMP	1
2.1	> DISCHARGE CHAMBER	1
2.2	> BEARING SPACER	1
2.3	> VALVE SEAT AND RETAINER	1
2.4	> VALVE CONE	1
3	SUCTION CASING AND STRAINER KIT TWI PUMP	1
3.1	> SUCTION INTERCONNECTOR	1
3.2	> STRAINER	1



TWI4-0739-DM (4068757)

Item	Description	Quantity
1	OTHERS STAGES KIT TWI4-07 PUMP	1
1.1	> DIFFUSER WITH RETURN GUIDE VANE	1
1.2	> PUMP IS 7 IMPELLER	1
1.3	> INTERMEDIATE BEARING	1
1.4	> NECK RING + STAINLESS STEEL PART (AISI)	1
2	STANDARD CASING DISCHARGE TWI4-07 PUMP	1
2.1	> DISCHARGE CHAMBER	1
2.2	> BEARING SPACER	1
2.3	> VALVE SEAT AND RETAINER	1
2.4	> VALVE CONE	1
3	SUCTION CASING AND STRAINER KIT TWI PUMP	1
3.1	> SUCTION INTERCONNECTOR	1
3.2	> STRAINER	1

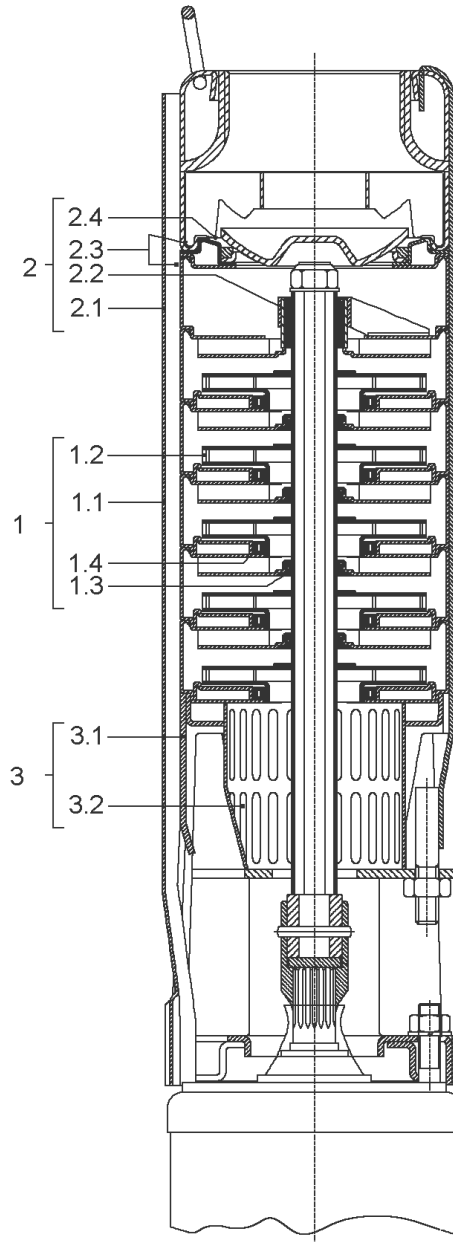

TWI4-0744-DM (4068758)

Item	Description	Quantity
1	OTHERS STAGES KIT TWI4-07 PUMP	1
1.1	> DIFFUSER WITH RETURN GUIDE VANE	1
1.2	> PUMP IS 7 IMPELLER	1
1.3	> INTERMEDIATE BEARING	1
1.4	> NECK RING + STAINLESS STEEL PART (AISI)	1
2	STANDARD CASING DISCHARGE TWI4-07 PUMP	1
2.1	> DISCHARGE CHAMBER	1
2.2	> BEARING SPACER	1
2.3	> VALVE SEAT AND RETAINER	1
2.4	> VALVE CONE	1
3	SUCTION CASING AND STRAINER KIT TWI PUMP	1
3.1	> SUCTION INTERCONNECTOR	1
3.2	> STRAINER	1

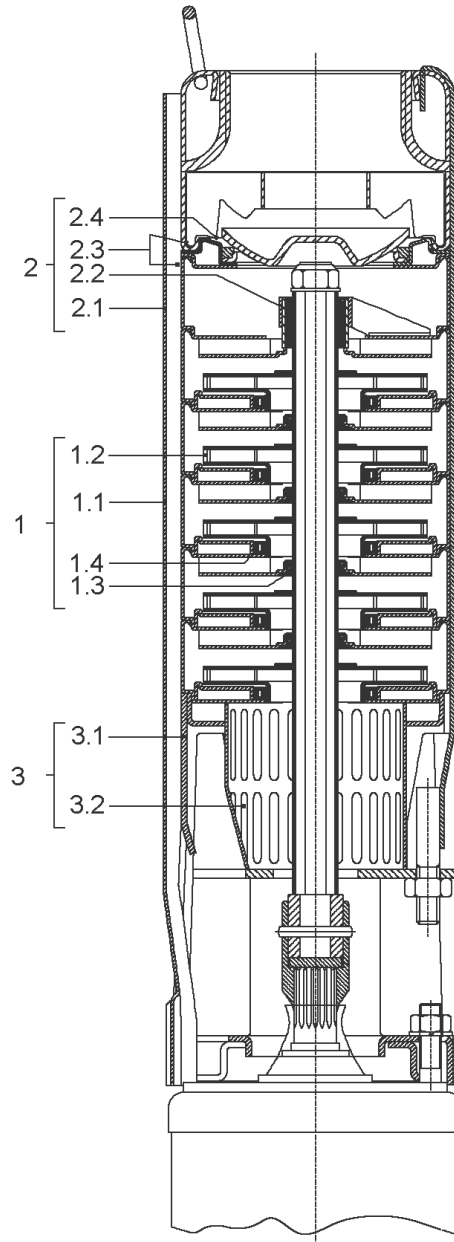

TWI4-0749-DM (4068759)

Item	Description	Quantity
1	OTHERS STAGES KIT TWI4-07 PUMP	1
1.1	> DIFFUSER WITH RETURN GUIDE VANE	1
1.2	> PUMP IS 7 IMPELLER	1
1.3	> INTERMEDIATE BEARING	1
1.4	> NECK RING + STAINLESS STEEL PART (AISI)	1
2	SEVERE DUTY DISCHARGE KIT TWI4-07 PUMP	1
Note: no longer available / nicht mehr lieferbar / ne plus disponible		
2.1	> SEVERE DUTY DISCHARGE CHAMBER	1
2.2	> BEARING SPACER	1
3	SUCTION CASING AND STRAINER KIT TWI PUMP	1
3.1	> SUCTION INTERCONNECTOR	1
3.2	> STRAINER	1



TWI4-0754-DM (4068760)

Item	Description	Quantity
1	OTHERS STAGES KIT TWI4-07 PUMP	1
1.1	> DIFFUSER WITH RETURN GUIDE VANE	1
1.2	> PUMP IS 7 IMPELLER	1
1.3	> INTERMEDIATE BEARING	1
1.4	> NECK RING + STAINLESS STEEL PART (AISI)	1
2	SEVERE DUTY DISCHARGE KIT TWI4-07 PUMP	1
Note: no longer available / nicht mehr lieferbar / ne plus disponible		
2.1	> SEVERE DUTY DISCHARGE CHAMBER	1
2.2	> BEARING SPACER	1
3	SUCTION CASING AND STRAINER KIT TWI PUMP	1
3.1	> SUCTION INTERCONNECTOR	1
3.2	> STRAINER	1



TWI4-0759-DM (4068761)

Item	Description	Quantity
1	OTHERS STAGES KIT TWI4-07 PUMP	1
1.1	> DIFFUSER WITH RETURN GUIDE VANE	1
1.2	> PUMP IS 7 IMPELLER	1
1.3	> INTERMEDIATE BEARING	1
1.4	> NECK RING + STAINLESS STEEL PART (AISI)	1
2	SEVERE DUTY DISCHARGE KIT TWI4-07 PUMP	1
Note: no longer available / nicht mehr lieferbar / ne plus disponible		
2.1	> SEVERE DUTY DISCHARGE CHAMBER	1
2.2	> BEARING SPACER	1
3	SUCTION CASING AND STRAINER KIT TWI PUMP	1
3.1	> SUCTION INTERCONNECTOR	1
3.2	> STRAINER	1

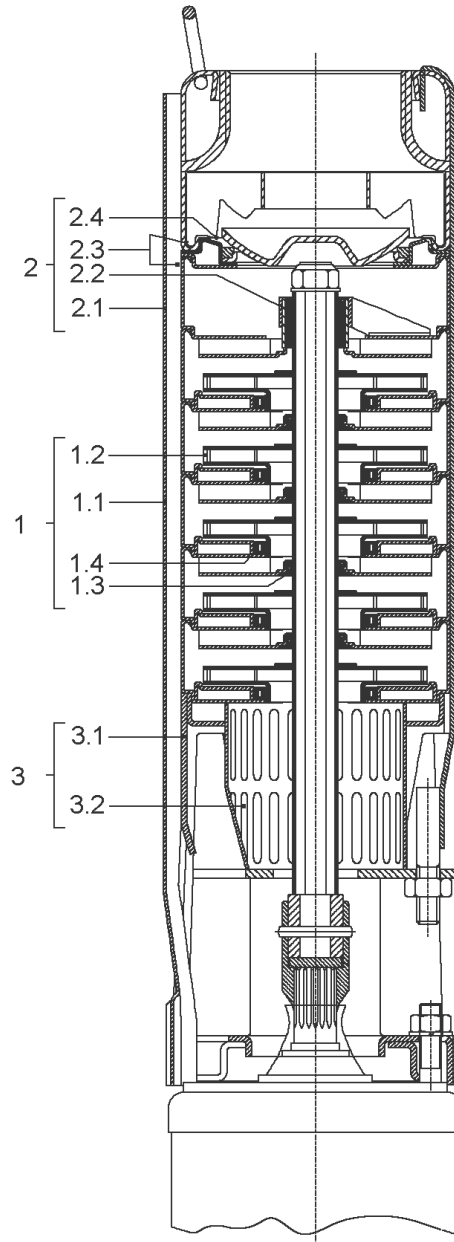

TWI4-0764-DM (4068762)

Item	Description	Quantity
1	OTHERS STAGES KIT TWI4-07 PUMP	1
1.1	> DIFFUSER WITH RETURN GUIDE VANE	1
1.2	> PUMP IS 7 IMPELLER	1
1.3	> INTERMEDIATE BEARING	1
1.4	> NECK RING + STAINLESS STEEL PART (AISI)	1
2	SEVERE DUTY DISCHARGE KIT TWI4-07 PUMP	1
Note: no longer available / nicht mehr lieferbar / ne plus disponible		
2.1	> SEVERE DUTY DISCHARGE CHAMBER	1
2.2	> BEARING SPACER	1
3	SUCTION CASING AND STRAINER KIT TWI PUMP	1
3.1	> SUCTION INTERCONNECTOR	1
3.2	> STRAINER	1

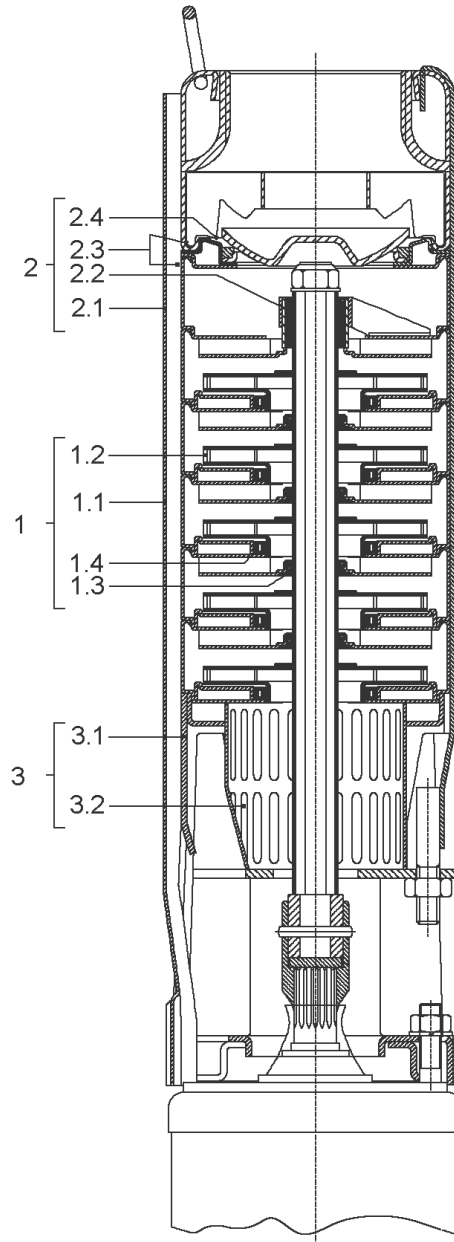

TWI4-1203-DM (4068763)

Item	Description	Quantity
1	OTHERS STAGES KIT TWI4-12 PUMP	1
1.1	> DIFFUSER WITH RETURN GUIDE VANE	1
1.2	> PUMP IS 12 IMPELLER	1
1.3	> INTERMEDIATE BEARING	1
1.4	> NECK RING + STAINLESS STEEL PART (AISI)	1
2	STANDARD CASING DISCHARGE TWI4-12 PUMP	1
2.1	> DISCHARGE CHAMBER	1
2.2	> BEARING SPACER	1
2.3	> VALVE SEAT AND RETAINER	1
2.4	> VALVE CONE	1
3	SUCTION CASING AND STRAINER KIT TWI PUMP	1
3.1	> SUCTION INTERCONNECTOR	1
3.2	> STRAINER	1



TWI4-1205-DM (4068764)

Item	Description	Quantity
1	OTHERS STAGES KIT TWI4-12 PUMP	1
1.1	> DIFFUSER WITH RETURN GUIDE VANE	1
1.2	> PUMP IS 12 IMPELLER	1
1.3	> INTERMEDIATE BEARING	1
1.4	> NECK RING + STAINLESS STEEL PART (AISI)	1
2	STANDARD CASING DISCHARGE TWI4-12 PUMP	1
2.1	> DISCHARGE CHAMBER	1
2.2	> BEARING SPACER	1
2.3	> VALVE SEAT AND RETAINER	1
2.4	> VALVE CONE	1
3	SUCTION CASING AND STRAINER KIT TWI PUMP	1
3.1	> SUCTION INTERCONNECTOR	1
3.2	> STRAINER	1



TWI4-1208-DM (4068765)

Item	Description	Quantity
1	OTHERS STAGES KIT TWI4-12 PUMP	1
1.1	> DIFFUSER WITH RETURN GUIDE VANE	1
1.2	> PUMP IS 12 IMPELLER	1
1.3	> INTERMEDIATE BEARING	1
1.4	> NECK RING + STAINLESS STEEL PART (AISI)	1
2	STANDARD CASING DISCHARGE TWI4-12 PUMP	1
2.1	> DISCHARGE CHAMBER	1
2.2	> BEARING SPACER	1
2.3	> VALVE SEAT AND RETAINER	1
2.4	> VALVE CONE	1
3	SUCTION CASING AND STRAINER KIT TWI PUMP	1
3.1	> SUCTION INTERCONNECTOR	1
3.2	> STRAINER	1

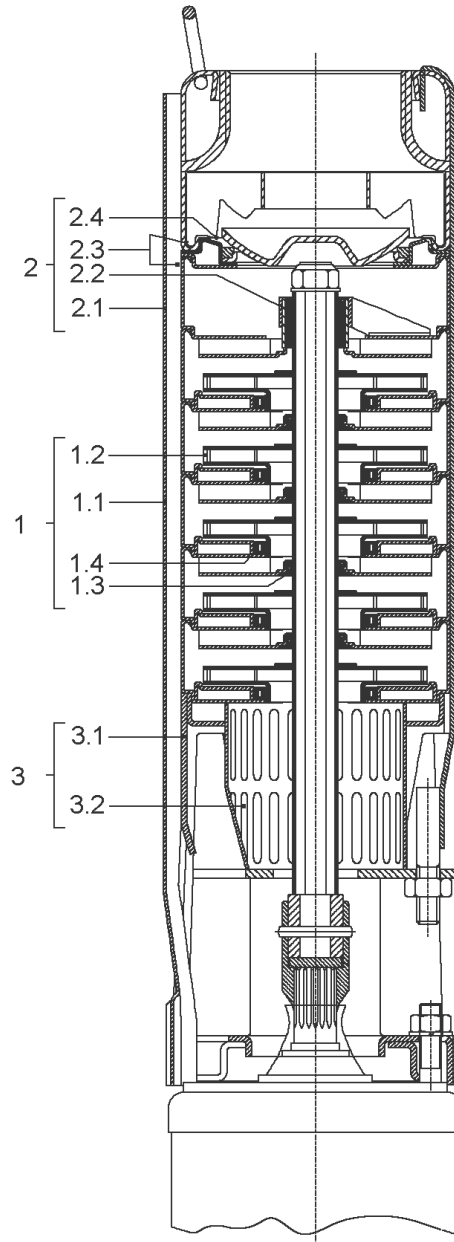

TWI4-1210-DM (4068766)

Item	Description	Quantity
1	OTHERS STAGES KIT TWI4-12 PUMP	1
1.1	> DIFFUSER WITH RETURN GUIDE VANE	1
1.2	> PUMP IS 12 IMPELLER	1
1.3	> INTERMEDIATE BEARING	1
1.4	> NECK RING + STAINLESS STEEL PART (AISI)	1
2	STANDARD CASING DISCHARGE TWI4-12 PUMP	1
2.1	> DISCHARGE CHAMBER	1
2.2	> BEARING SPACER	1
2.3	> VALVE SEAT AND RETAINER	1
2.4	> VALVE CONE	1
3	SUCTION CASING AND STRAINER KIT TWI PUMP	1
3.1	> SUCTION INTERCONNECTOR	1
3.2	> STRAINER	1

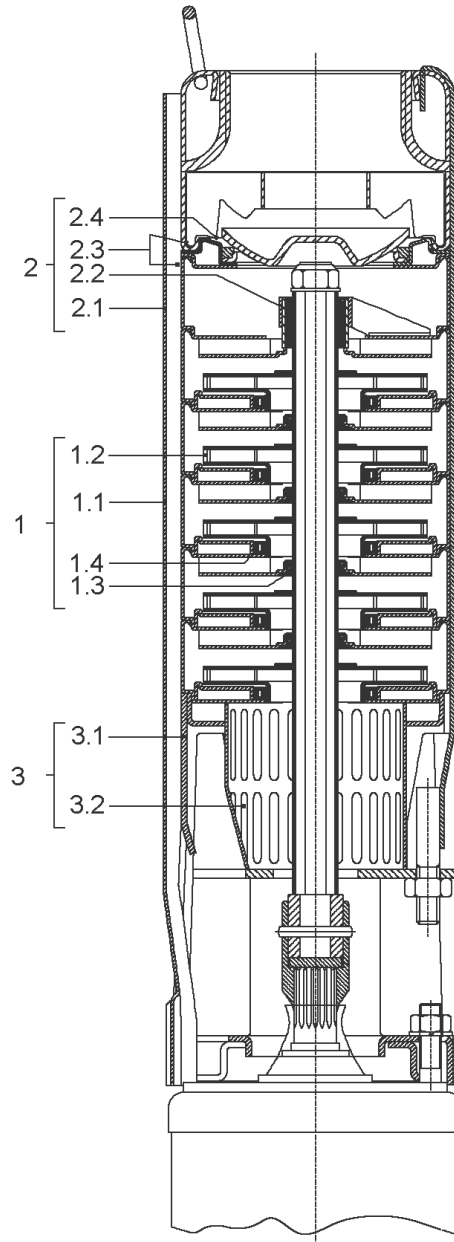

TWI4-1213-DM (4068767)

Item	Description	Quantity
1	OTHERS STAGES KIT TWI4-12 PUMP	1
1.1	> DIFFUSER WITH RETURN GUIDE VANE	1
1.2	> PUMP IS 12 IMPELLER	1
1.3	> INTERMEDIATE BEARING	1
1.4	> NECK RING + STAINLESS STEEL PART (AISI)	1
2	STANDARD CASING DISCHARGE TWI4-12 PUMP	1
2.1	> DISCHARGE CHAMBER	1
2.2	> BEARING SPACER	1
2.3	> VALVE SEAT AND RETAINER	1
2.4	> VALVE CONE	1
3	SUCTION CASING AND STRAINER KIT TWI PUMP	1
3.1	> SUCTION INTERCONNECTOR	1
3.2	> STRAINER	1



TWI4-1214-DM (4068768)

Item	Description	Quantity
1	OTHERS STAGES KIT TWI4-12 PUMP	1
1.1	> DIFFUSER WITH RETURN GUIDE VANE	1
1.2	> PUMP IS 12 IMPELLER	1
1.3	> INTERMEDIATE BEARING	1
1.4	> NECK RING + STAINLESS STEEL PART (AISI)	1
2	STANDARD CASING DISCHARGE TWI4-12 PUMP	1
2.1	> DISCHARGE CHAMBER	1
2.2	> BEARING SPACER	1
2.3	> VALVE SEAT AND RETAINER	1
2.4	> VALVE CONE	1
3	SUCTION CASING AND STRAINER KIT TWI PUMP	1
3.1	> SUCTION INTERCONNECTOR	1
3.2	> STRAINER	1



TWI4-1217-DM (4068769)

Item	Description	Quantity
1	OTHERS STAGES KIT TWI4-12 PUMP	1
1.1	> DIFFUSER WITH RETURN GUIDE VANE	1
1.2	> PUMP IS 12 IMPELLER	1
1.3	> INTERMEDIATE BEARING	1
1.4	> NECK RING + STAINLESS STEEL PART (AISI)	1
2	STANDARD CASING DISCHARGE TWI4-12 PUMP	1
2.1	> DISCHARGE CHAMBER	1
2.2	> BEARING SPACER	1
2.3	> VALVE SEAT AND RETAINER	1
2.4	> VALVE CONE	1
3	SUCTION CASING AND STRAINER KIT TWI PUMP	1
3.1	> SUCTION INTERCONNECTOR	1
3.2	> STRAINER	1

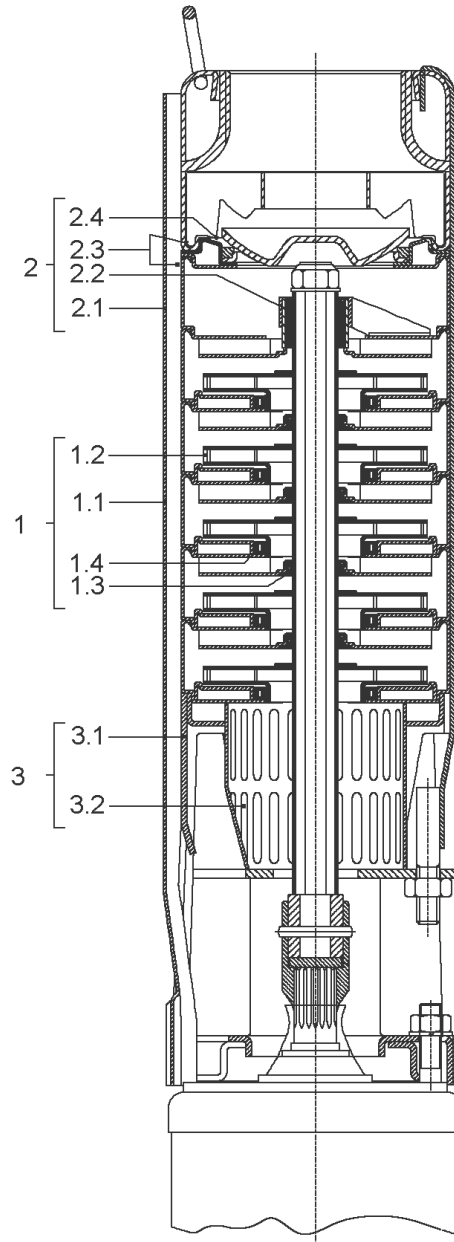

TWI4-1220-DM (4068770)

Item	Description	Quantity
1	OTHERS STAGES KIT TWI4-12 PUMP	1
1.1	> DIFFUSER WITH RETURN GUIDE VANE	1
1.2	> PUMP IS 12 IMPELLER	1
1.3	> INTERMEDIATE BEARING	1
1.4	> NECK RING + STAINLESS STEEL PART (AISI)	1
2	STANDARD CASING DISCHARGE TWI4-12 PUMP	1
2.1	> DISCHARGE CHAMBER	1
2.2	> BEARING SPACER	1
2.3	> VALVE SEAT AND RETAINER	1
2.4	> VALVE CONE	1
3	SUCTION CASING AND STRAINER KIT TWI PUMP	1
3.1	> SUCTION INTERCONNECTOR	1
3.2	> STRAINER	1

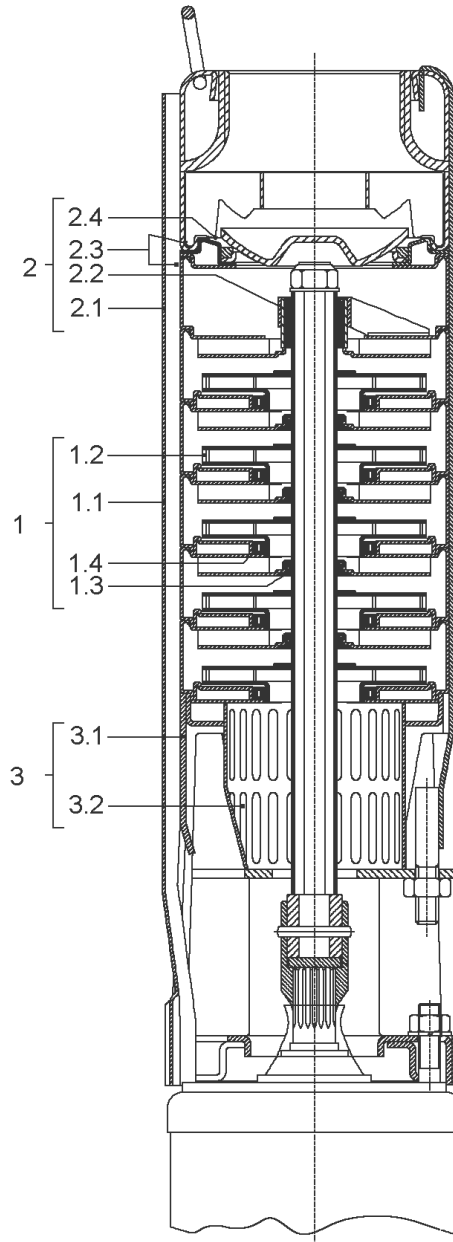

TWI4-1224-DM (4068771)

Item	Description	Quantity
1	OTHERS STAGES KIT TWI4-12 PUMP	1
1.1	> DIFFUSER WITH RETURN GUIDE VANE	1
1.2	> PUMP IS 12 IMPELLER	1
1.3	> INTERMEDIATE BEARING	1
1.4	> NECK RING + STAINLESS STEEL PART (AISI)	1
2	STANDARD CASING DISCHARGE TWI4-12 PUMP	1
2.1	> DISCHARGE CHAMBER	1
2.2	> BEARING SPACER	1
2.3	> VALVE SEAT AND RETAINER	1
2.4	> VALVE CONE	1
3	SUCTION CASING AND STRAINER KIT TWI PUMP	1
3.1	> SUCTION INTERCONNECTOR	1
3.2	> STRAINER	1



TWI4-1227-DM (4068772)

Item	Description	Quantity
1	OTHERS STAGES KIT TWI4-12 PUMP	1
1.1	> DIFFUSER WITH RETURN GUIDE VANE	1
1.2	> PUMP IS 12 IMPELLER	1
1.3	> INTERMEDIATE BEARING	1
1.4	> NECK RING + STAINLESS STEEL PART (AISI)	1
2	STANDARD CASING DISCHARGE TWI4-12 PUMP	1
2.1	> DISCHARGE CHAMBER	1
2.2	> BEARING SPACER	1
2.3	> VALVE SEAT AND RETAINER	1
2.4	> VALVE CONE	1
3	SUCTION CASING AND STRAINER KIT TWI PUMP	1
3.1	> SUCTION INTERCONNECTOR	1
3.2	> STRAINER	1



TWI4-0206-EM (4068823)

Item	Article no.	Description	Quantity
1		OTHERS STAGES KIT TWI4-02 PUMP	1
Note: no longer available / nicht mehr lieferbar / ne plus disponible			
1.1		> DIFFUSER WITH RETURN GUIDE VANE	1
1.2		> PUMP IS 2 IMPELLER	1
1.3		> INTERMEDIATE BEARING	1
1.4		> NECK RING + STAINLESS STEEL PART (AISI)	1
2		STANDARD CASING DISCHARGE TWI4-02 PUMP	1
2.1		> DISCHARGE CHAMBER	1
2.2		> BEARING SPACER	1
2.3		> VALVE SEAT AND RETAINER	1
2.4		> VALVE CONE	1
3		SUCTION CASING AND STRAINER KIT TWI PUMP	1
3.1		> SUCTION INTERCONNECTOR	1
3.2		> STRAINER	1
	4063927	CAPACITOR 16µf	1

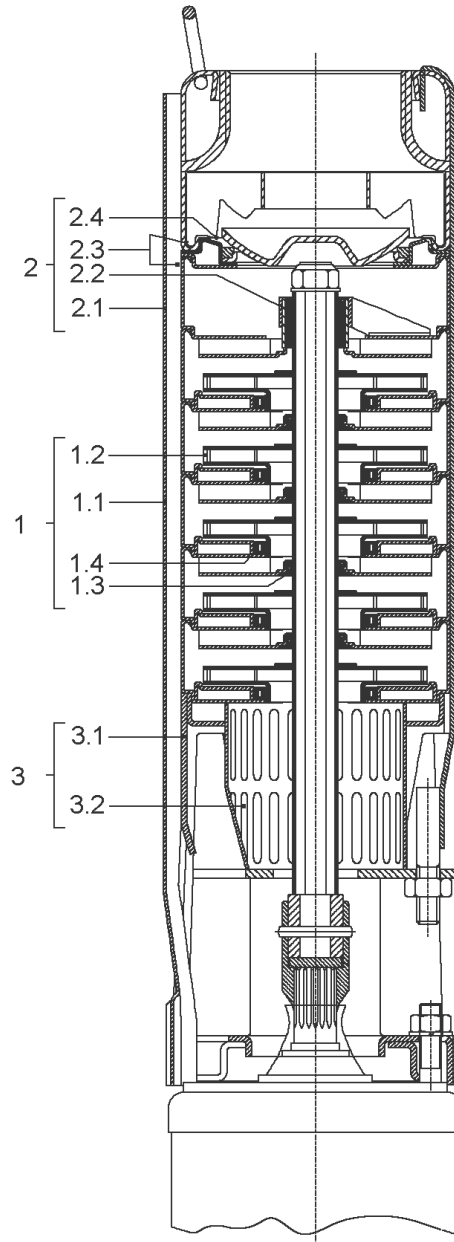

TWI4-0208-EM (4068824)

Item	Article no.	Description	Quantity
1		OTHERS STAGES KIT TWI4-02 PUMP	1
Note: no longer available / nicht mehr lieferbar / ne plus disponible			
1.1		> DIFFUSER WITH RETURN GUIDE VANE	1
1.2		> PUMP IS 2 IMPELLER	1
1.3		> INTERMEDIATE BEARING	1
1.4		> NECK RING + STAINLESS STEEL PART (AISI)	1
2		STANDARD CASING DISCHARGE TWI4-02 PUMP	1
Note: no longer available / nicht mehr lieferbar / ne plus disponible			
2.1		> DISCHARGE CHAMBER	1
2.2		> BEARING SPACER	1
2.3		> VALVE SEAT AND RETAINER	1
2.4		> VALVE CONE	1
3		SUCTION CASING AND STRAINER KIT TWI PUMP	1
3.1		> SUCTION INTERCONNECTOR	1
3.2		> STRAINER	1
	4063927	CAPACITOR 16µf	1

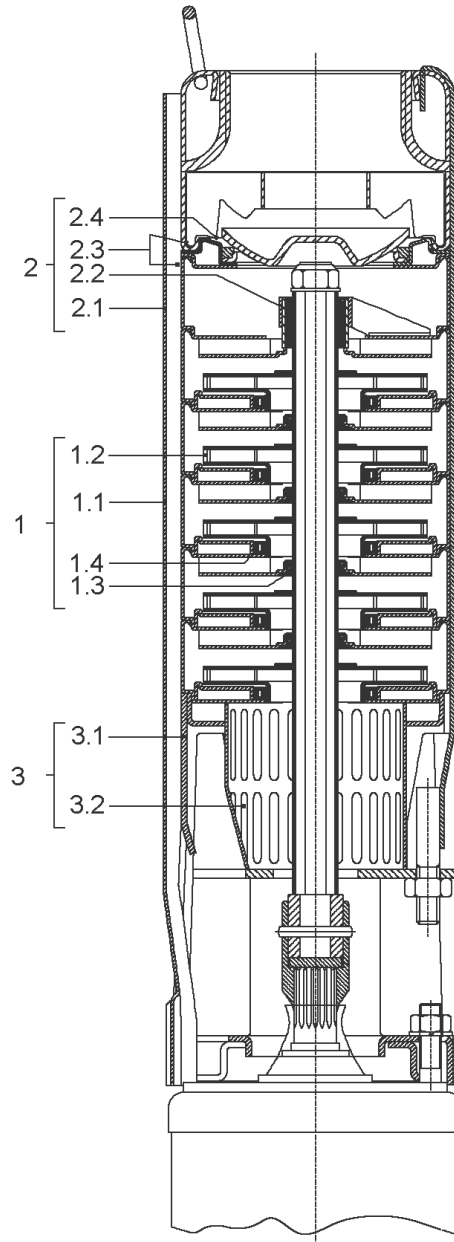

TWI4-0213-EM (4068825)

Item	Article no.	Description	Quantity
1		OTHERS STAGES KIT TWI4-02 PUMP	1
Note: no longer available / nicht mehr lieferbar / ne plus disponible			
1.1		> DIFFUSER WITH RETURN GUIDE VANE	1
1.2		> PUMP IS 2 IMPELLER	1
1.3		> INTERMEDIATE BEARING	1
1.4		> NECK RING + STAINLESS STEEL PART (AISI)	1
2		STANDARD CASING DISCHARGE TWI4-02 PUMP	1
Note: no longer available / nicht mehr lieferbar / ne plus disponible			
2.1		> DISCHARGE CHAMBER	1
2.2		> BEARING SPACER	1
2.3		> VALVE SEAT AND RETAINER	1
2.4		> VALVE CONE	1
3		SUCTION CASING AND STRAINER KIT TWI PUMP	1
3.1		> SUCTION INTERCONNECTOR	1
3.2		> STRAINER	1
	4003576	CAPACITOR-20MF	1



TWI4-0217-EM (4068826)

Item	Article no.	Description	Quantity
1		OTHERS STAGES KIT TWI4-02 PUMP	1
Note: no longer available / nicht mehr lieferbar / ne plus disponible			
1.1		> DIFFUSER WITH RETURN GUIDE VANE	1
1.2		> PUMP IS 2 IMPELLER	1
1.3		> INTERMEDIATE BEARING	1
1.4		> NECK RING + STAINLESS STEEL PART (AISI)	1
2		STANDARD CASING DISCHARGE TWI4-02 PUMP	1
Note: no longer available / nicht mehr lieferbar / ne plus disponible			
2.1		> DISCHARGE CHAMBER	1
2.2		> BEARING SPACER	1
2.3		> VALVE SEAT AND RETAINER	1
2.4		> VALVE CONE	1
3		SUCTION CASING AND STRAINER KIT TWI PUMP	1
3.1		> SUCTION INTERCONNECTOR	1
3.2		> STRAINER	1
	6083974	capacitor 30µF VP.	1

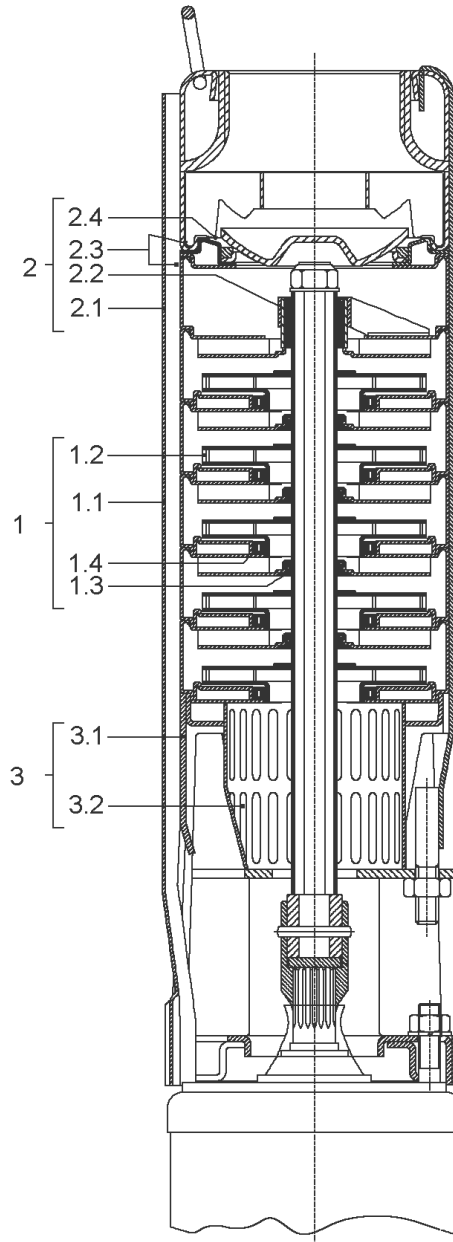

TWI4-0221-EM (4068827)

Item	Article no.	Description	Quantity
1		OTHERS STAGES KIT TWI4-02 PUMP	1
Note: no longer available / nicht mehrlieferbar / ne plus disponible			
1.1		> DIFFUSER WITH RETURN GUIDE VANE	1
1.2		> PUMP IS 2 IMPELLER	1
1.3		> INTERMEDIATE BEARING	1
1.4		> NECK RING + STAINLESS STEEL PART (AISI)	1
2		STANDARD CASING DISCHARGE TWI4-02 PUMP	1
Note: no longer available / nicht mehrlieferbar / ne plus disponible			
2.1		> DISCHARGE CHAMBER	1
2.2		> BEARING SPACER	1
2.3		> VALVE SEAT AND RETAINER	1
2.4		> VALVE CONE	1
3		SUCTION CASING AND STRAINER KIT TWI PUMP	1
3.1		> SUCTION INTERCONNECTOR	1
3.2		> STRAINER	1
	4003578	CAPACITOR-40MF	1

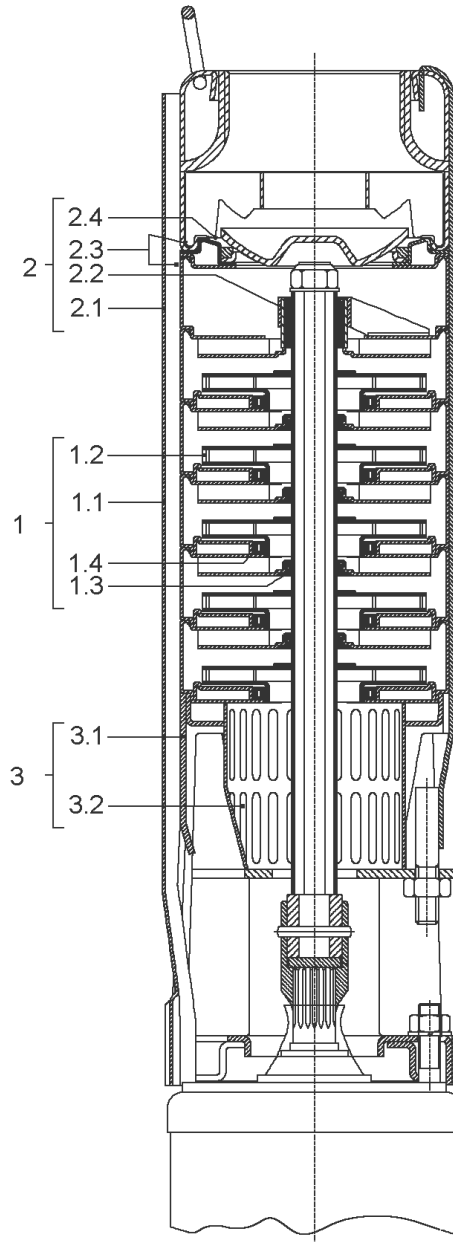

TWI4-0225-EM (4068828)

Item	Article no.	Description	Quantity
1		OTHERS STAGES KIT TWI4-02 PUMP	1
Note: no longer available / nicht mehr lieferbar / ne plus disponible			
1.1		> DIFFUSER WITH RETURN GUIDE VANE	1
1.2		> PUMP IS 2 IMPELLER	1
1.3		> INTERMEDIATE BEARING	1
1.4		> NECK RING + STAINLESS STEEL PART (AISI)	1
2		STANDARD CASING DISCHARGE TWI4-02 PUMP	1
Note: no longer available / nicht mehr lieferbar / ne plus disponible			
2.1		> DISCHARGE CHAMBER	1
2.2		> BEARING SPACER	1
2.3		> VALVE SEAT AND RETAINER	1
2.4		> VALVE CONE	1
3		SUCTION CASING AND STRAINER KIT TWI PUMP	1
3.1		> SUCTION INTERCONNECTOR	1
3.2		> STRAINER	1
	4003578	CAPACITOR-40MF	1

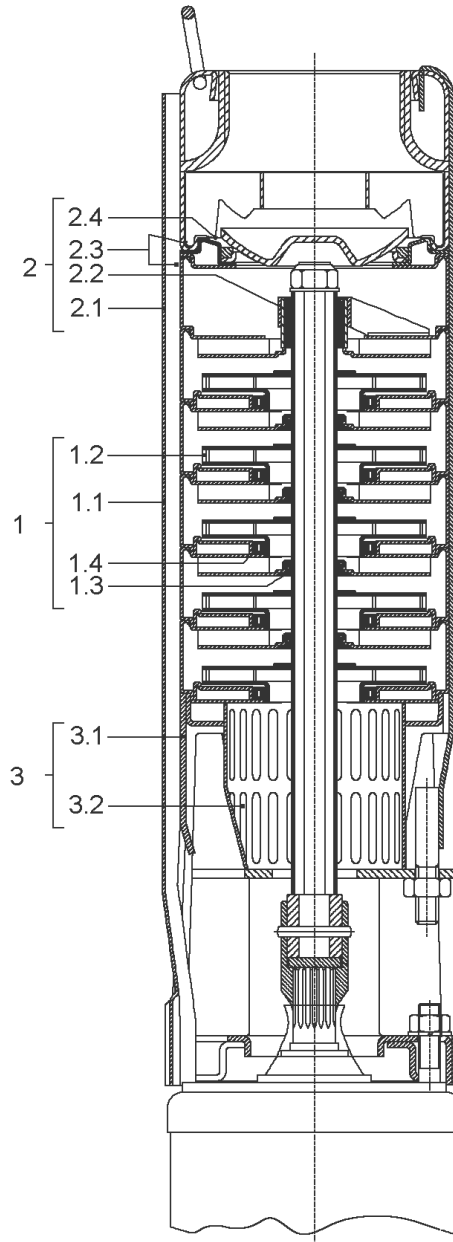

TWI4-0230-EM (4068829)

Item	Article no.	Description	Quantity
1		OTHERS STAGES KIT TWI4-02 PUMP	1
Note: no longer available / nicht mehr lieferbar / ne plus disponible			
1.1		> DIFFUSER WITH RETURN GUIDE VANE	1
1.2		> PUMP IS 2 IMPELLER	1
1.3		> INTERMEDIATE BEARING	1
1.4		> NECK RING + STAINLESS STEEL PART (AISI)	1
2		STANDARD CASING DISCHARGE TWI4-02 PUMP	1
Note: no longer available / nicht mehr lieferbar / ne plus disponible			
2.1		> DISCHARGE CHAMBER	1
2.2		> BEARING SPACER	1
2.3		> VALVE SEAT AND RETAINER	1
2.4		> VALVE CONE	1
3		SUCTION CASING AND STRAINER KIT TWI PUMP	1
3.1		> SUCTION INTERCONNECTOR	1
3.2		> STRAINER	1
	4003579	CAPACITOR-50MF	1

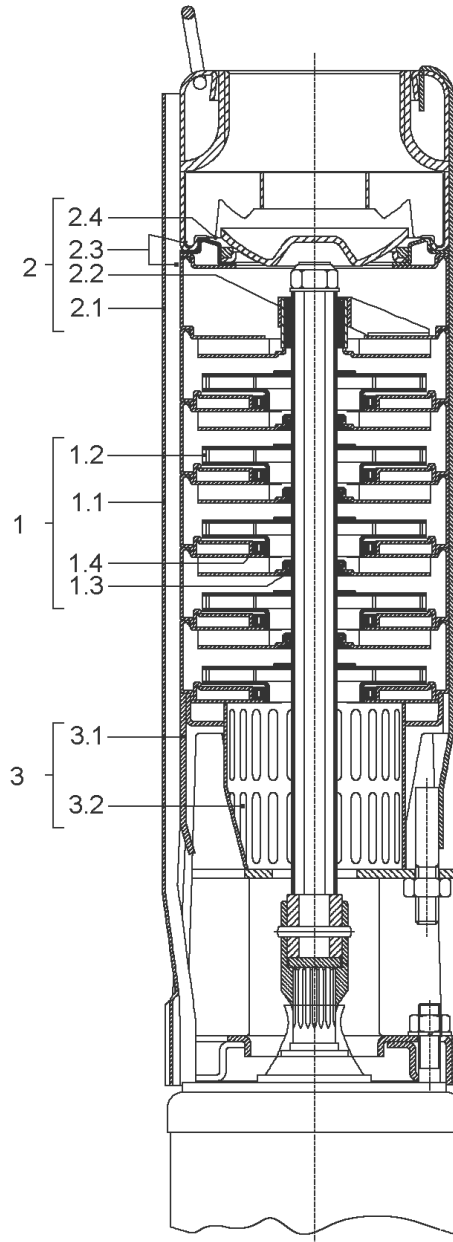

TWI4-0235-EM (4068830)

Item	Article no.	Description	Quantity
1		OTHERS STAGES KIT TWI4-02 PUMP	1
Note: no longer available / nicht mehr lieferbar / ne plus disponible			
1.1		> DIFFUSER WITH RETURN GUIDE VANE	1
1.2		> PUMP IS 2 IMPELLER	1
1.3		> INTERMEDIATE BEARING	1
1.4		> NECK RING + STAINLESS STEEL PART (AISI)	1
2		STANDARD CASING DISCHARGE TWI4-02 PUMP	1
Note: no longer available / nicht mehr lieferbar / ne plus disponible			
2.1		> DISCHARGE CHAMBER	1
2.2		> BEARING SPACER	1
2.3		> VALVE SEAT AND RETAINER	1
2.4		> VALVE CONE	1
3		SUCTION CASING AND STRAINER KIT TWI PUMP	1
3.1		> SUCTION INTERCONNECTOR	1
3.2		> STRAINER	1
	4003579	CAPACITOR-50MF	1

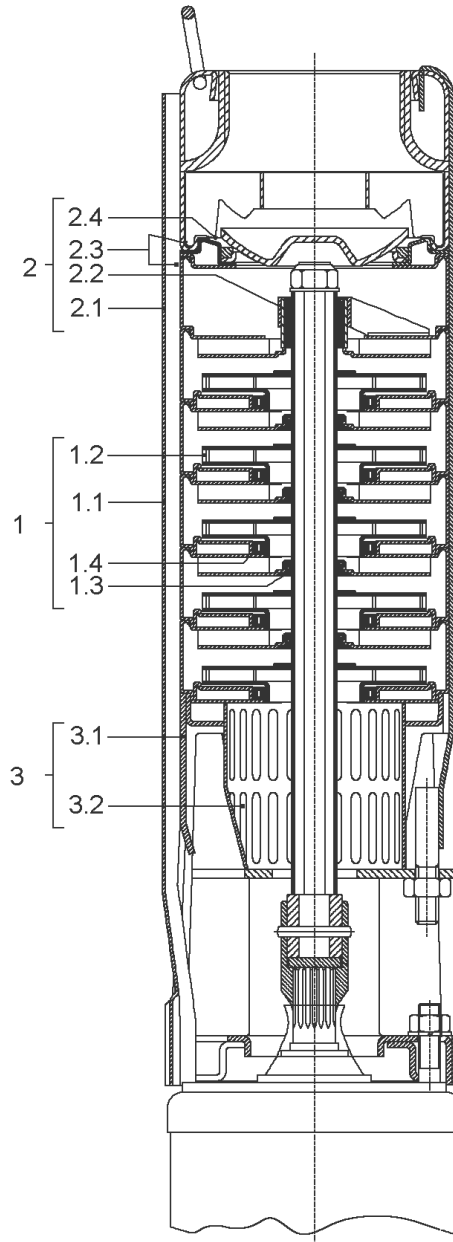

TWI4-0240-EM (4068831)

Item	Article no.	Description	Quantity
1		OTHERS STAGES KIT TWI4-02 PUMP	1
Note: no longer available / nicht mehr lieferbar / ne plus disponible			
1.1		> DIFFUSER WITH RETURN GUIDE VANE	1
1.2		> PUMP IS 2 IMPELLER	1
1.3		> INTERMEDIATE BEARING	1
1.4		> NECK RING + STAINLESS STEEL PART (AISI)	1
2		STANDARD CASING DISCHARGE TWI4-02 PUMP	1
Note: no longer available / nicht mehr lieferbar / ne plus disponible			
2.1		> DISCHARGE CHAMBER	1
2.2		> BEARING SPACER	1
2.3		> VALVE SEAT AND RETAINER	1
2.4		> VALVE CONE	1
3		SUCTION CASING AND STRAINER KIT TWI PUMP	1
3.1		> SUCTION INTERCONNECTOR	1
3.2		> STRAINER	1
	4080849	CAPACITOR-75 MF	1

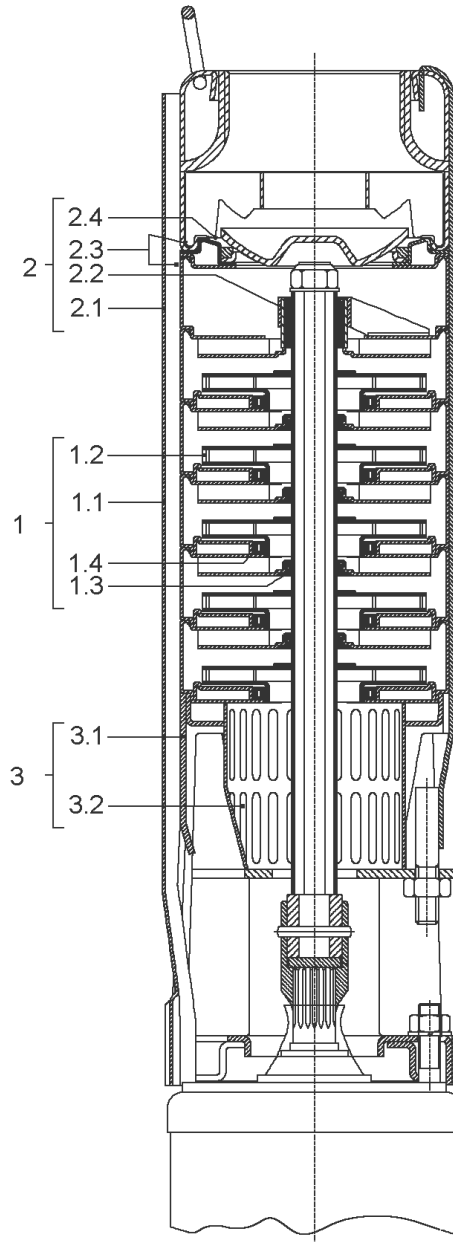

TWI4-0247-EM (4068832)

Item	Article no.	Description	Quantity
1		OTHERS STAGES KIT TWI4-02 PUMP	1
Note: no longer available / nicht mehr lieferbar / ne plus disponible			
1.1		> DIFFUSER WITH RETURN GUIDE VANE	1
1.2		> PUMP IS 2 IMPELLER	1
1.3		> INTERMEDIATE BEARING	1
1.4		> NECK RING + STAINLESS STEEL PART (AISI)	1
2		STANDARD CASING DISCHARGE TWI4-02 PUMP	1
Note: no longer available / nicht mehr lieferbar / ne plus disponible			
2.1		> DISCHARGE CHAMBER	1
2.2		> BEARING SPACER	1
2.3		> VALVE SEAT AND RETAINER	1
2.4		> VALVE CONE	1
3		SUCTION CASING AND STRAINER KIT TWI PUMP	1
3.1		> SUCTION INTERCONNECTOR	1
3.2		> STRAINER	1
	4080849	CAPACITOR-75 MF	1

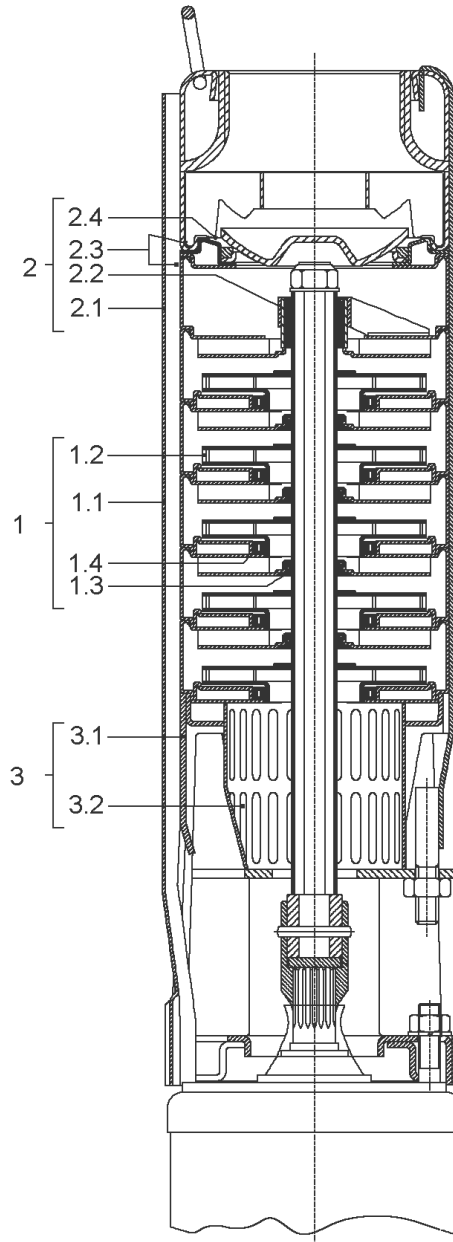

TWI4-0254-EM (4068833)

Item	Article no.	Description	Quantity
1		OTHERS STAGES KIT TWI4-02 PUMP	1
Note: no longer available / nicht mehr lieferbar / ne plus disponible			
1.1		> DIFFUSER WITH RETURN GUIDE VANE	1
1.2		> PUMP IS 2 IMPELLER	1
1.3		> INTERMEDIATE BEARING	1
1.4		> NECK RING + STAINLESS STEEL PART (AISI)	1
2		STANDARD CASING DISCHARGE TWI4-02 PUMP	1
Note: no longer available / nicht mehr lieferbar / ne plus disponible			
2.1		> DISCHARGE CHAMBER	1
2.2		> BEARING SPACER	1
2.3		> VALVE SEAT AND RETAINER	1
2.4		> VALVE CONE	1
3		SUCTION CASING AND STRAINER KIT TWI PUMP	1
3.1		> SUCTION INTERCONNECTOR	1
3.2		> STRAINER	1
	4080849	CAPACITOR-75 MF	1

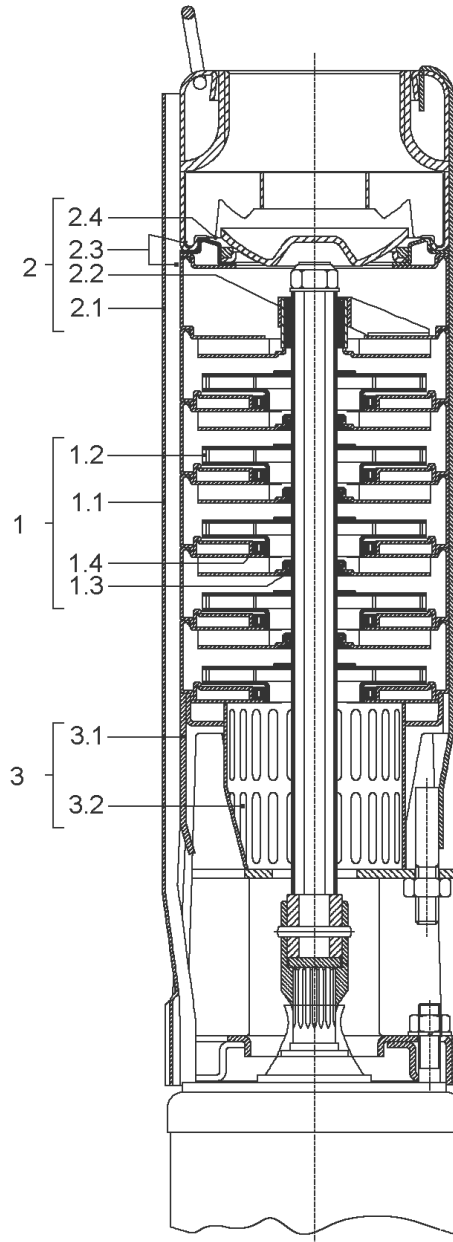

TWI4-0306-EM (4068834)

Item	Article no.	Description	Quantity
1		OTHERS STAGES KIT TWI4-03 PUMP	1
1.1		> DIFFUSER WITH RETURN GUIDE VANE	1
1.2		> PUMP IS 3 IMPELLER	1
1.3		> INTERMEDIATE BEARING	1
1.4		> NECK RING + STAINLESS STEEL PART (AISI)	1
2		SEVERE DUTY DISCHARGE KIT TWI4-03 PUMP	1
Note: no longer available / nicht mehr lieferbar / ne plus disponible			
2.1		> SEVERE DUTY DISCHARGE CHAMBER	1
2.2		> BEARING SPACER	1
3		SUCTION CASING AND STRAINER KIT TWI PUMP	1
3.1		> SUCTION INTERCONNECTOR	1
3.2		> STRAINER	1
	4063927	CAPACITOR 16µf	1



TWI4-0309-EM (4068835)

Item	Article no.	Description	Quantity
1		OTHERS STAGES KIT TWI4-03 PUMP	1
1.1		> DIFFUSER WITH RETURN GUIDE VANE	1
1.2		> PUMP IS 3 IMPELLER	1
1.3		> INTERMEDIATE BEARING	1
1.4		> NECK RING + STAINLESS STEEL PART (AISI)	1
2		SEVERE DUTY DISCHARGE KIT TWI4-03 PUMP	1
Note: no longer available / nicht mehr lieferbar / ne plus disponible			
2.1		> SEVERE DUTY DISCHARGE CHAMBER	1
2.2		> BEARING SPACER	1
3		SUCTION CASING AND STRAINER KIT TWI PUMP	1
3.1		> SUCTION INTERCONNECTOR	1
3.2		> STRAINER	1
	4003576	CAPACITOR-20MF	1

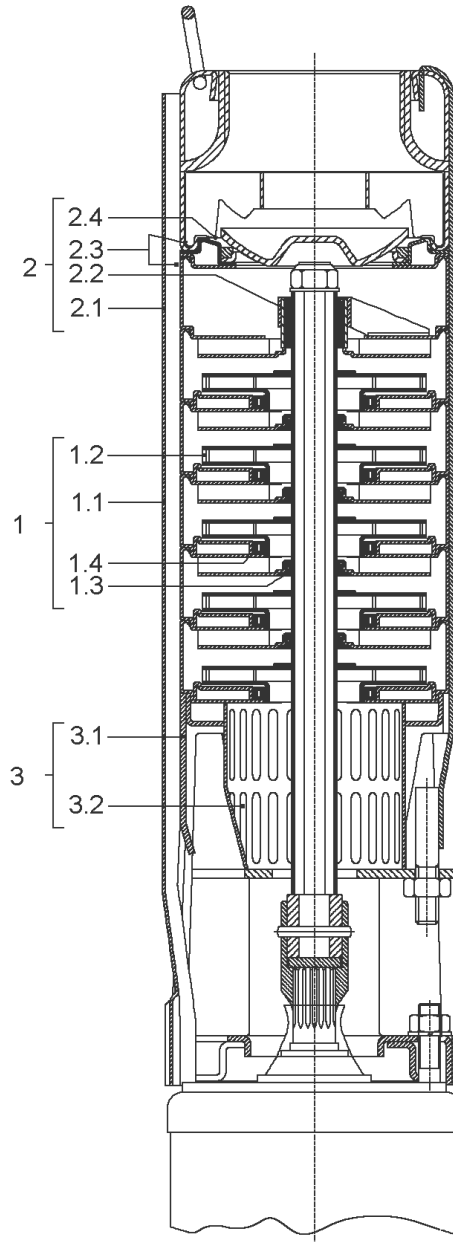

TWI4-0312-EM (4068836)

Item	Article no.	Description	Quantity
1		OTHERS STAGES KIT TWI4-03 PUMP	1
1.1		> DIFFUSER WITH RETURN GUIDE VANE	1
1.2		> PUMP IS 3 IMPELLER	1
1.3		> INTERMEDIATE BEARING	1
1.4		> NECK RING + STAINLESS STEEL PART (AISI)	1
2		SEVERE DUTY DISCHARGE KIT TWI4-03 PUMP	1
Note: no longer available / nicht mehr lieferbar / ne plus disponible			
2.1		> SEVERE DUTY DISCHARGE CHAMBER	1
2.2		> BEARING SPACER	1
3		SUCTION CASING AND STRAINER KIT TWI PUMP	1
3.1		> SUCTION INTERCONNECTOR	1
3.2		> STRAINER	1
	6083974	capacitor 30μF VP.	1

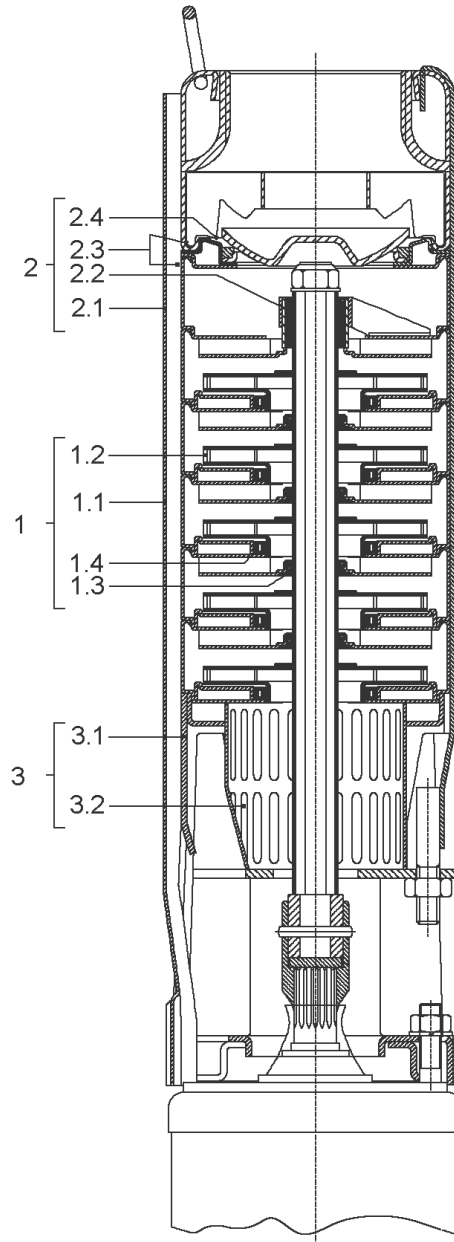

TWI4-0315-EM (4068837)

Item	Article no.	Description	Quantity
1		OTHERS STAGES KIT TWI4-03 PUMP	1
1.1		> DIFFUSER WITH RETURN GUIDE VANE	1
1.2		> PUMP IS 3 IMPELLER	1
1.3		> INTERMEDIATE BEARING	1
1.4		> NECK RING + STAINLESS STEEL PART (AISI)	1
2		SEVERE DUTY DISCHARGE KIT TWI4-03 PUMP	1
Note: no longer available / nicht mehr lieferbar / ne plus disponible			
2.1		> SEVERE DUTY DISCHARGE CHAMBER	1
2.2		> BEARING SPACER	1
3		SUCTION CASING AND STRAINER KIT TWI PUMP	1
3.1		> SUCTION INTERCONNECTOR	1
3.2		> STRAINER	1
	4003578	CAPACITOR-40MF	1



TWI4-0318-EM (4068838)

Item	Article no.	Description	Quantity
1		OTHERS STAGES KIT TWI4-03 PUMP	1
1.1		> DIFFUSER WITH RETURN GUIDE VANE	1
1.2		> PUMP IS 3 IMPELLER	1
1.3		> INTERMEDIATE BEARING	1
1.4		> NECK RING + STAINLESS STEEL PART (AISI)	1
2		SEVERE DUTY DISCHARGE KIT TWI4-03 PUMP	1
Note: no longer available / nicht mehr lieferbar / ne plus disponible			
2.1		> SEVERE DUTY DISCHARGE CHAMBER	1
2.2		> BEARING SPACER	1
3		SUCTION CASING AND STRAINER KIT TWI PUMP	1
3.1		> SUCTION INTERCONNECTOR	1
3.2		> STRAINER	1
	4003578	CAPACITOR-40MF	1



TWI4-0322-EM (4068839)

Item	Article no.	Description	Quantity
1		OTHERS STAGES KIT TWI4-03 PUMP	1
1.1		> DIFFUSER WITH RETURN GUIDE VANE	1
1.2		> PUMP IS 3 IMPELLER	1
1.3		> INTERMEDIATE BEARING	1
1.4		> NECK RING + STAINLESS STEEL PART (AISI)	1
2		SEVERE DUTY DISCHARGE KIT TWI4-03 PUMP	1
Note: no longer available / nicht mehr lieferbar / ne plus disponible			
2.1		> SEVERE DUTY DISCHARGE CHAMBER	1
2.2		> BEARING SPACER	1
3		SUCTION CASING AND STRAINER KIT TWI PUMP	1
3.1		> SUCTION INTERCONNECTOR	1
3.2		> STRAINER	1
	4003579	CAPACITOR-50MF	1

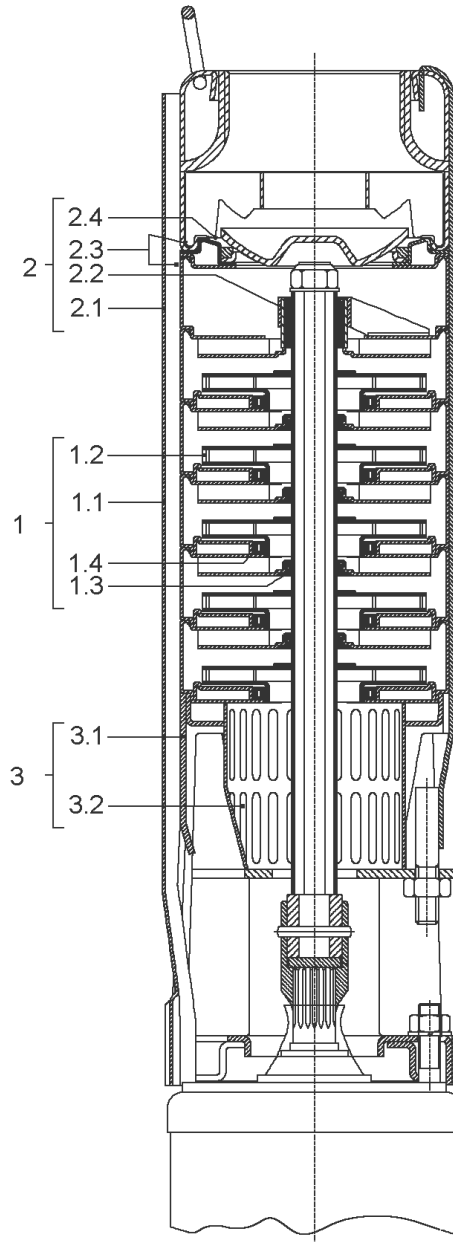

TWI4-0325-EM (4068840)

Item	Article no.	Description	Quantity
1		OTHERS STAGES KIT TWI4-03 PUMP	1
1.1		> DIFFUSER WITH RETURN GUIDE VANE	1
1.2		> PUMP IS 3 IMPELLER	1
1.3		> INTERMEDIATE BEARING	1
1.4		> NECK RING + STAINLESS STEEL PART (AISI)	1
2		SEVERE DUTY DISCHARGE KIT TWI4-03 PUMP	1
Note: no longer available / nicht mehr lieferbar / ne plus disponible			
2.1		> SEVERE DUTY DISCHARGE CHAMBER	1
2.2		> BEARING SPACER	1
3		SUCTION CASING AND STRAINER KIT TWI PUMP	1
3.1		> SUCTION INTERCONNECTOR	1
3.2		> STRAINER	1
	4003579	CAPACITOR-50MF	1

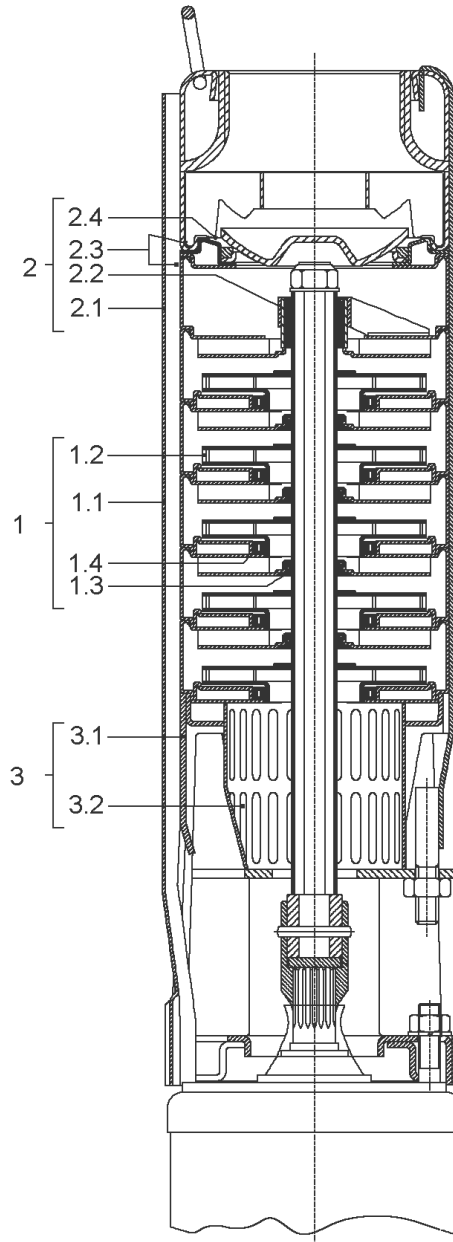

TWI4-0330-EM (4068841)

Item	Article no.	Description	Quantity
1		OTHERS STAGES KIT TWI4-03 PUMP	1
1.1		> DIFFUSER WITH RETURN GUIDE VANE	1
1.2		> PUMP IS 3 IMPELLER	1
1.3		> INTERMEDIATE BEARING	1
1.4		> NECK RING + STAINLESS STEEL PART (AISI)	1
2		SEVERE DUTY DISCHARGE KIT TWI4-03 PUMP	1
Note: no longer available / nicht mehr lieferbar / ne plus disponible			
2.1		> SEVERE DUTY DISCHARGE CHAMBER	1
2.2		> BEARING SPACER	1
3		SUCTION CASING AND STRAINER KIT TWI PUMP	1
3.1		> SUCTION INTERCONNECTOR	1
3.2		> STRAINER	1
	4080849	CAPACITOR-75 MF	1



TWI4-0336-EM (4068842)

Item	Article no.	Description	Quantity
1		OTHERS STAGES KIT TWI4-03 PUMP	1
1.1		> DIFFUSER WITH RETURN GUIDE VANE	1
1.2		> PUMP IS 3 IMPELLER	1
1.3		> INTERMEDIATE BEARING	1
1.4		> NECK RING + STAINLESS STEEL PART (AISI)	1
2		SEVERE DUTY DISCHARGE KIT TWI4-03 PUMP	1
Note: no longer available / nicht mehr lieferbar / ne plus disponible			
2.1		> SEVERE DUTY DISCHARGE CHAMBER	1
2.2		> BEARING SPACER	1
3		SUCTION CASING AND STRAINER KIT TWI PUMP	1
3.1		> SUCTION INTERCONNECTOR	1
3.2		> STRAINER	1
	4080849	CAPACITOR-75 MF	1



TWI4-0404-EM (4068843)

Item	Article no.	Description	Quantity
1		OTHERS STAGES KIT TWI4-04 PUMP	1
1.1		> DIFFUSER WITH RETURN GUIDE VANE	1
1.2		> PUMP IS 4 IMPELLER	1
1.3		> INTERMEDIATE BEARING	1
1.4		> NECK RING + STAINLESS STEEL PART (AISI)	1
2		SEVERE DUTY DISCHARGE KIT TWI4-04 PUMP	1
Note: no longer available / nicht mehr lieferbar / ne plus disponible			
2.1		> SEVERE DUTY DISCHARGE CHAMBER	1
2.2		> BEARING SPACER	1
3		SUCTION CASING AND STRAINER KIT TWI PUMP	1
3.1		> SUCTION INTERCONNECTOR	1
3.2		> STRAINER	1
	4063927	CAPACITOR 16µf	1

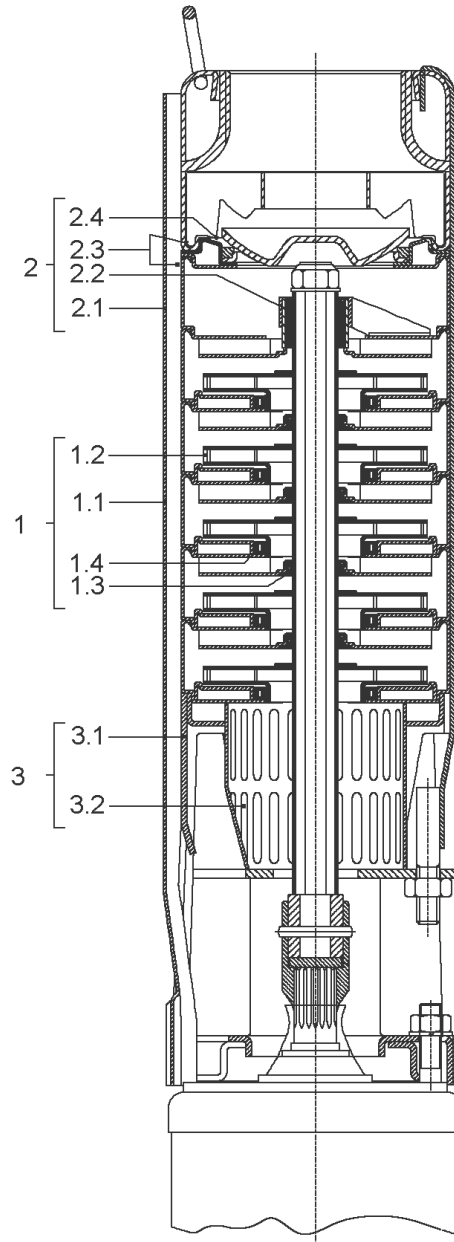

TWI4-0407-EM (4068844)

Item	Article no.	Description	Quantity
1		OTHERS STAGES KIT TWI4-04 PUMP	1
1.1		> DIFFUSER WITH RETURN GUIDE VANE	1
1.2		> PUMP IS 4 IMPELLER	1
1.3		> INTERMEDIATE BEARING	1
1.4		> NECK RING + STAINLESS STEEL PART (AISI)	1
2		SEVERE DUTY DISCHARGE KIT TWI4-04 PUMP	1
Note: no longer available / nicht mehr lieferbar / ne plus disponible			
2.1		> SEVERE DUTY DISCHARGE CHAMBER	1
2.2		> BEARING SPACER	1
3		SUCTION CASING AND STRAINER KIT TWI PUMP	1
3.1		> SUCTION INTERCONNECTOR	1
3.2		> STRAINER	1
	4003576	CAPACITOR-20MF	1

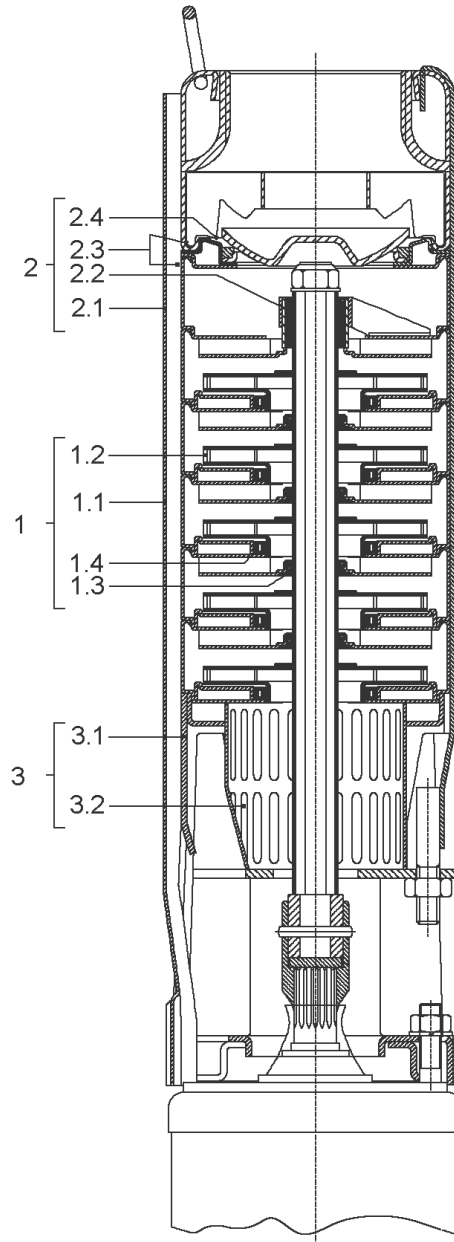

TWI4-0409-EM (4068845)

Item	Article no.	Description	Quantity
1		OTHERS STAGES KIT TWI4-04 PUMP	1
1.1		> DIFFUSER WITH RETURN GUIDE VANE	1
1.2		> PUMP IS 4 IMPELLER	1
1.3		> INTERMEDIATE BEARING	1
1.4		> NECK RING + STAINLESS STEEL PART (AISI)	1
2		SEVERE DUTY DISCHARGE KIT TWI4-04 PUMP	1
Note: no longer available / nicht mehr lieferbar / ne plus disponible			
2.1		> SEVERE DUTY DISCHARGE CHAMBER	1
2.2		> BEARING SPACER	1
3		SUCTION CASING AND STRAINER KIT TWI PUMP	1
3.1		> SUCTION INTERCONNECTOR	1
3.2		> STRAINER	1
	6083974	capacitor 30μF VP.	1



TWI4-0414-EM (4068846)

Item	Article no.	Description	Quantity
1		OTHERS STAGES KIT TWI4-04 PUMP	1
1.1		> DIFFUSER WITH RETURN GUIDE VANE	1
1.2		> PUMP IS 4 IMPELLER	1
1.3		> INTERMEDIATE BEARING	1
1.4		> NECK RING + STAINLESS STEEL PART (AISI)	1
2		SEVERE DUTY DISCHARGE KIT TWI4-04 PUMP	1
Note: no longer available / nicht mehr lieferbar / ne plus disponible			
2.1		> SEVERE DUTY DISCHARGE CHAMBER	1
2.2		> BEARING SPACER	1
3		SUCTION CASING AND STRAINER KIT TWI PUMP	1
3.1		> SUCTION INTERCONNECTOR	1
3.2		> STRAINER	1
	4003578	CAPACITOR-40MF	1



TWI4-0419-EM (4068847)

Item	Article no.	Description	Quantity
1		OTHERS STAGES KIT TWI4-04 PUMP	1
1.1		> DIFFUSER WITH RETURN GUIDE VANE	1
1.2		> PUMP IS 4 IMPELLER	1
1.3		> INTERMEDIATE BEARING	1
1.4		> NECK RING + STAINLESS STEEL PART (AISI)	1
2		SEVERE DUTY DISCHARGE KIT TWI4-04 PUMP	1
Note: no longer available / nicht mehr lieferbar / ne plus disponible			
2.1		> SEVERE DUTY DISCHARGE CHAMBER	1
2.2		> BEARING SPACER	1
3		SUCTION CASING AND STRAINER KIT TWI PUMP	1
3.1		> SUCTION INTERCONNECTOR	1
3.2		> STRAINER	1
	4003579	CAPACITOR-50MF	1

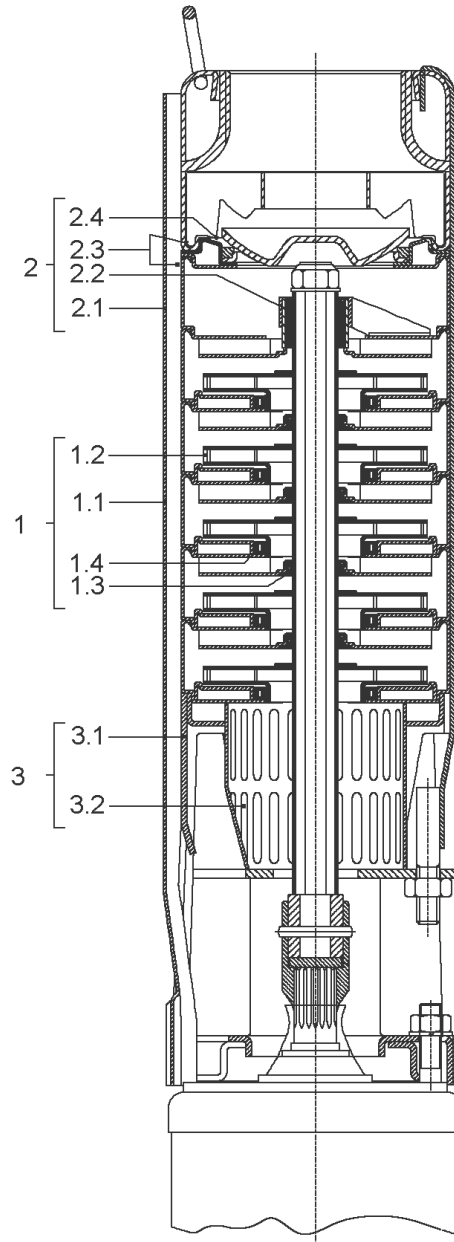

TWI4-0424-EM (4068848)

Item	Article no.	Description	Quantity
1		OTHERS STAGES KIT TWI4-04 PUMP	1
1.1		> DIFFUSER WITH RETURN GUIDE VANE	1
1.2		> PUMP IS 4 IMPELLER	1
1.3		> INTERMEDIATE BEARING	1
1.4		> NECK RING + STAINLESS STEEL PART (AISI)	1
2		SEVERE DUTY DISCHARGE KIT TWI4-04 PUMP	1
Note: no longer available / nicht mehr lieferbar / ne plus disponible			
2.1		> SEVERE DUTY DISCHARGE CHAMBER	1
2.2		> BEARING SPACER	1
3		SUCTION CASING AND STRAINER KIT TWI PUMP	1
3.1		> SUCTION INTERCONNECTOR	1
3.2		> STRAINER	1
	4080849	CAPACITOR-75 MF	1

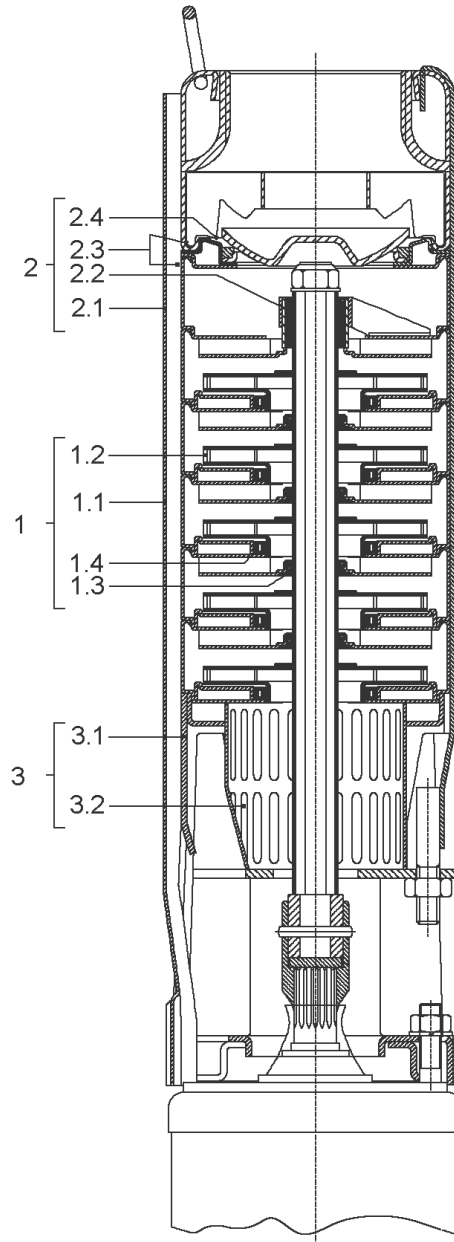

TWI4-0429-EM (4068849)

Item	Article no.	Description	Quantity
1		OTHERS STAGES KIT TWI4-04 PUMP	1
1.1		> DIFFUSER WITH RETURN GUIDE VANE	1
1.2		> PUMP IS 4 IMPELLER	1
1.3		> INTERMEDIATE BEARING	1
1.4		> NECK RING + STAINLESS STEEL PART (AISI)	1
2		SEVERE DUTY DISCHARGE KIT TWI4-04 PUMP	1
Note: no longer available / nicht mehr lieferbar / ne plus disponible			
2.1		> SEVERE DUTY DISCHARGE CHAMBER	1
2.2		> BEARING SPACER	1
3		SUCTION CASING AND STRAINER KIT TWI PUMP	1
3.1		> SUCTION INTERCONNECTOR	1
3.2		> STRAINER	1
	4080849	CAPACITOR-75 MF	1



TWI4-0703-EM (4068850)

Item	Article no.	Description	Quantity
1		OTHERS STAGES KIT TWI4-07 PUMP	1
1.1		> DIFFUSER WITH RETURN GUIDE VANE	1
1.2		> PUMP IS 7 IMPELLER	1
1.3		> INTERMEDIATE BEARING	1
1.4		> NECK RING + STAINLESS STEEL PART (AISI)	1
2		SEVERE DUTY DISCHARGE KIT TWI4-07 PUMP	1
Note: no longer available / nicht mehr lieferbar / ne plus disponible			
2.1		> SEVERE DUTY DISCHARGE CHAMBER	1
2.2		> BEARING SPACER	1
3		SUCTION CASING AND STRAINER KIT TWI PUMP	1
3.1		> SUCTION INTERCONNECTOR	1
3.2		> STRAINER	1
	4063927	CAPACITOR 16µf	1



TWI4-0704-EM (4068851)

Item	Article no.	Description	Quantity
1		OTHERS STAGES KIT TWI4-07 PUMP	1
1.1		> DIFFUSER WITH RETURN GUIDE VANE	1
1.2		> PUMP IS 7 IMPELLER	1
1.3		> INTERMEDIATE BEARING	1
1.4		> NECK RING + STAINLESS STEEL PART (AISI)	1
2		SEVERE DUTY DISCHARGE KIT TWI4-07 PUMP	1
Note: no longer available / nicht mehr lieferbar / ne plus disponible			
2.1		> SEVERE DUTY DISCHARGE CHAMBER	1
2.2		> BEARING SPACER	1
3		SUCTION CASING AND STRAINER KIT TWI PUMP	1
3.1		> SUCTION INTERCONNECTOR	1
3.2		> STRAINER	1
	4003576	CAPACITOR-20MF	1

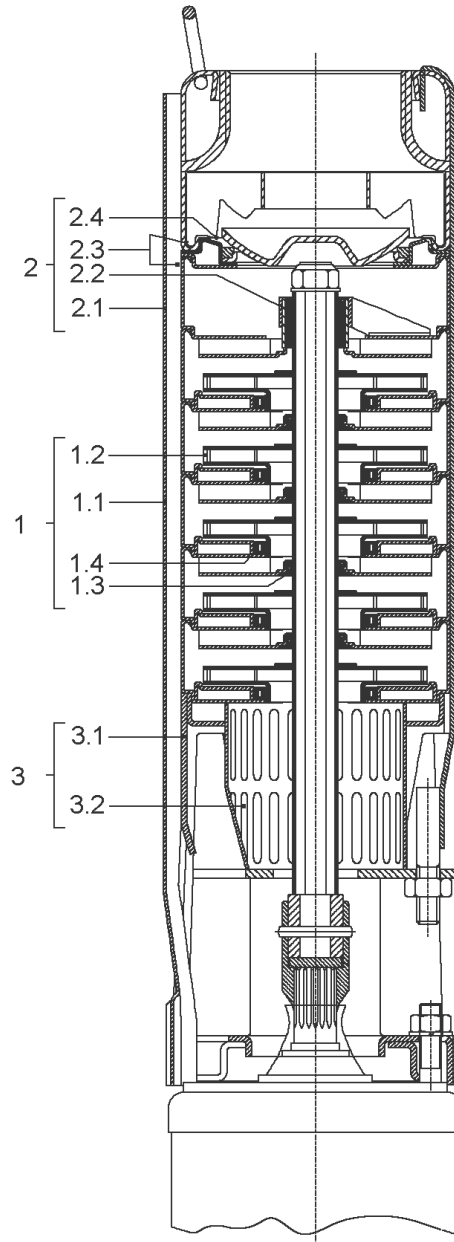

TWI4-0706-EM (4068852)

Item	Article no.	Description	Quantity
1		OTHERS STAGES KIT TWI4-07 PUMP	1
1.1		> DIFFUSER WITH RETURN GUIDE VANE	1
1.2		> PUMP IS 7 IMPELLER	1
1.3		> INTERMEDIATE BEARING	1
1.4		> NECK RING + STAINLESS STEEL PART (AISI)	1
2		SEVERE DUTY DISCHARGE KIT TWI4-07 PUMP	1
Note: no longer available / nicht mehr lieferbar / ne plus disponible			
2.1		> SEVERE DUTY DISCHARGE CHAMBER	1
2.2		> BEARING SPACER	1
3		SUCTION CASING AND STRAINER KIT TWI PUMP	1
3.1		> SUCTION INTERCONNECTOR	1
3.2		> STRAINER	1
	6083974	capacitor 30μF VP.	1

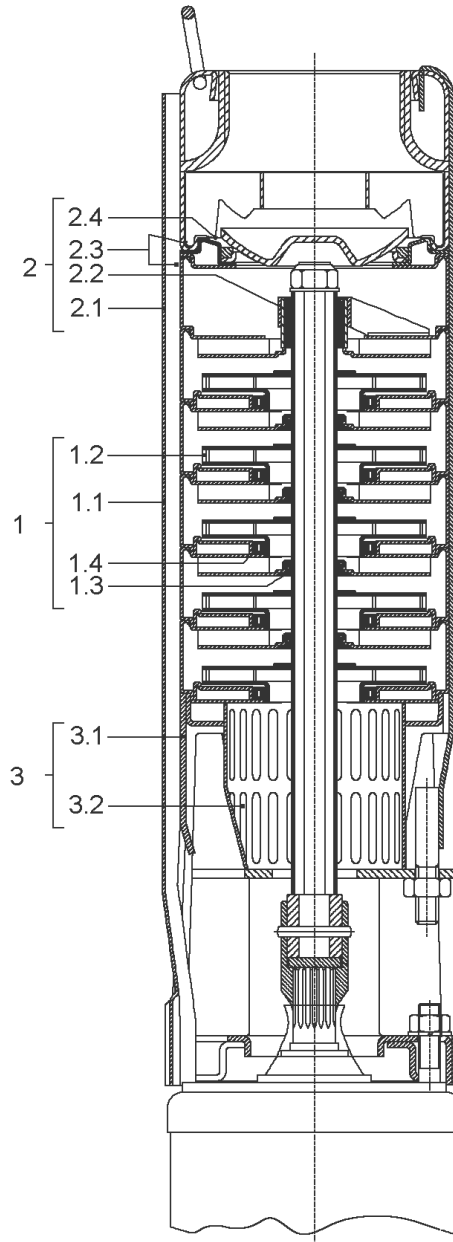

TWI4-0709-EM (4068853)

Item	Article no.	Description	Quantity
1		OTHERS STAGES KIT TWI4-07 PUMP	1
1.1		> DIFFUSER WITH RETURN GUIDE VANE	1
1.2		> PUMP IS 7 IMPELLER	1
1.3		> INTERMEDIATE BEARING	1
1.4		> NECK RING + STAINLESS STEEL PART (AISI)	1
2		SEVERE DUTY DISCHARGE KIT TWI4-07 PUMP	1
Note: no longer available / nicht mehr lieferbar / ne plus disponible			
2.1		> SEVERE DUTY DISCHARGE CHAMBER	1
2.2		> BEARING SPACER	1
3		SUCTION CASING AND STRAINER KIT TWI PUMP	1
3.1		> SUCTION INTERCONNECTOR	1
3.2		> STRAINER	1
	4003578	CAPACITOR-40MF	1

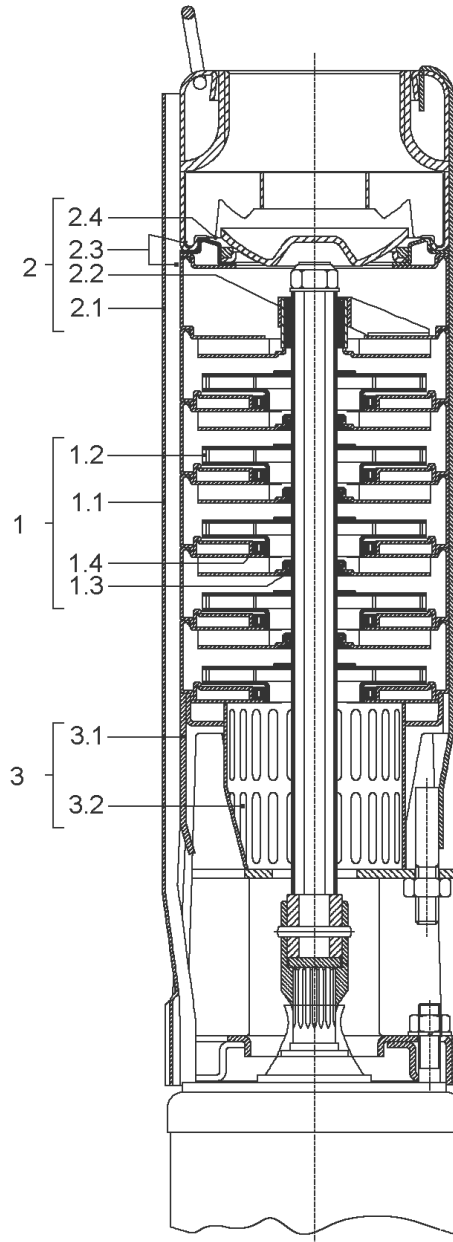

TWI4-0713-EM (4068854)

Item	Article no.	Description	Quantity
1		OTHERS STAGES KIT TWI4-07 PUMP	1
1.1		> DIFFUSER WITH RETURN GUIDE VANE	1
1.2		> PUMP IS 7 IMPELLER	1
1.3		> INTERMEDIATE BEARING	1
1.4		> NECK RING + STAINLESS STEEL PART (AISI)	1
2		SEVERE DUTY DISCHARGE KIT TWI4-07 PUMP	1
Note: no longer available / nicht mehr lieferbar / ne plus disponible			
2.1		> SEVERE DUTY DISCHARGE CHAMBER	1
2.2		> BEARING SPACER	1
3		SUCTION CASING AND STRAINER KIT TWI PUMP	1
3.1		> SUCTION INTERCONNECTOR	1
3.2		> STRAINER	1
	4003579	CAPACITOR-50MF	1

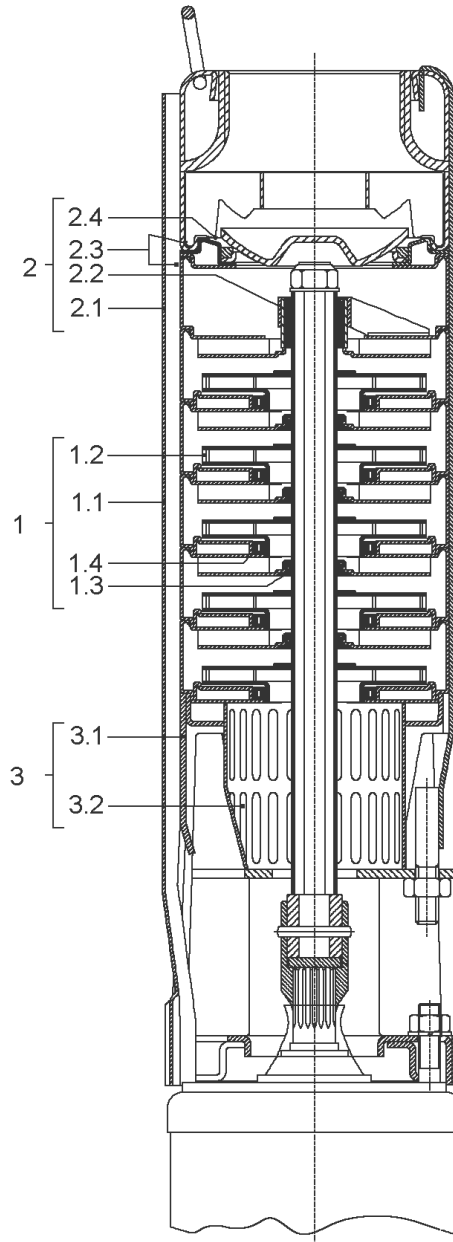

TWI4-0716-EM (4068855)

Item	Article no.	Description	Quantity
1		OTHERS STAGES KIT TWI4-07 PUMP	1
1.1		> DIFFUSER WITH RETURN GUIDE VANE	1
1.2		> PUMP IS 7 IMPELLER	1
1.3		> INTERMEDIATE BEARING	1
1.4		> NECK RING + STAINLESS STEEL PART (AISI)	1
2		SEVERE DUTY DISCHARGE KIT TWI4-07 PUMP	1
Note: no longer available / nicht mehr lieferbar / ne plus disponible			
2.1		> SEVERE DUTY DISCHARGE CHAMBER	1
2.2		> BEARING SPACER	1
3		SUCTION CASING AND STRAINER KIT TWI PUMP	1
3.1		> SUCTION INTERCONNECTOR	1
3.2		> STRAINER	1
	4080849	CAPACITOR-75 MF	1

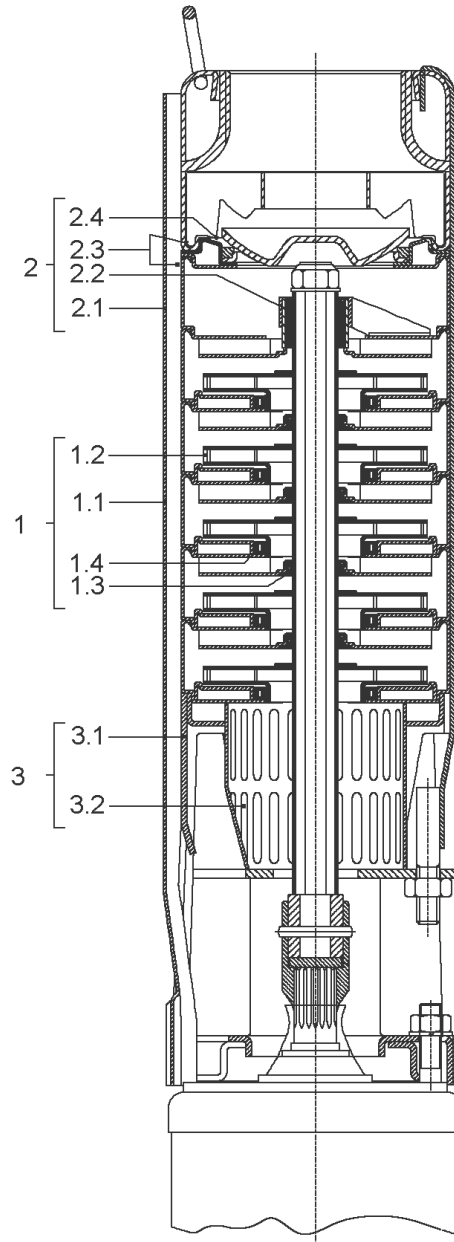

TWI4-0719-EM (4068856)

Item	Article no.	Description	Quantity
1		OTHERS STAGES KIT TWI4-07 PUMP	1
1.1		> DIFFUSER WITH RETURN GUIDE VANE	1
1.2		> PUMP IS 7 IMPELLER	1
1.3		> INTERMEDIATE BEARING	1
1.4		> NECK RING + STAINLESS STEEL PART (AISI)	1
2		SEVERE DUTY DISCHARGE KIT TWI4-07 PUMP	1
Note: no longer available / nicht mehr lieferbar / ne plus disponible			
2.1		> SEVERE DUTY DISCHARGE CHAMBER	1
2.2		> BEARING SPACER	1
3		SUCTION CASING AND STRAINER KIT TWI PUMP	1
3.1		> SUCTION INTERCONNECTOR	1
3.2		> STRAINER	1
	4080849	CAPACITOR-75 MF	1

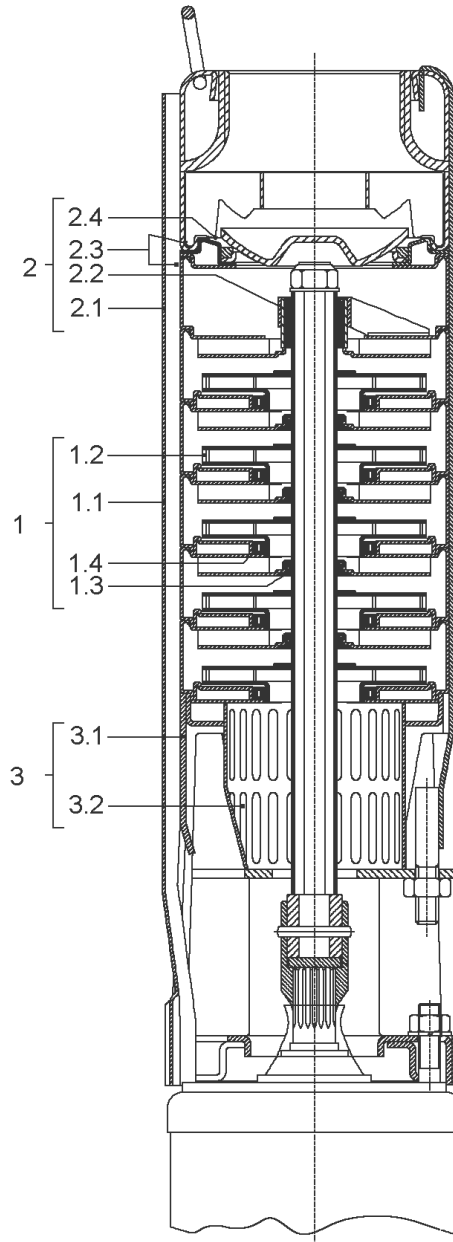

TWI4-1203-EM (4068857)

Item	Article no.	Description	Quantity
1		OTHERS STAGES KIT TWI4-12 PUMP	1
1.1		> DIFFUSER WITH RETURN GUIDE VANE	1
1.2		> PUMP IS 12 IMPELLER	1
1.3		> INTERMEDIATE BEARING	1
1.4		> NECK RING + STAINLESS STEEL PART (AISI)	1
2		SEVERE DUTY DISCHARGE KIT TWI12 PUMP	1
Note: no longer available / nicht mehr lieferbar / ne plus disponible			
3		SUCTION CASING AND STRAINER KIT TWI PUMP	1
3.1		> SUCTION INTERCONNECTOR	1
3.2		> STRAINER	1
	4003578	CAPACITOR-40MF	1

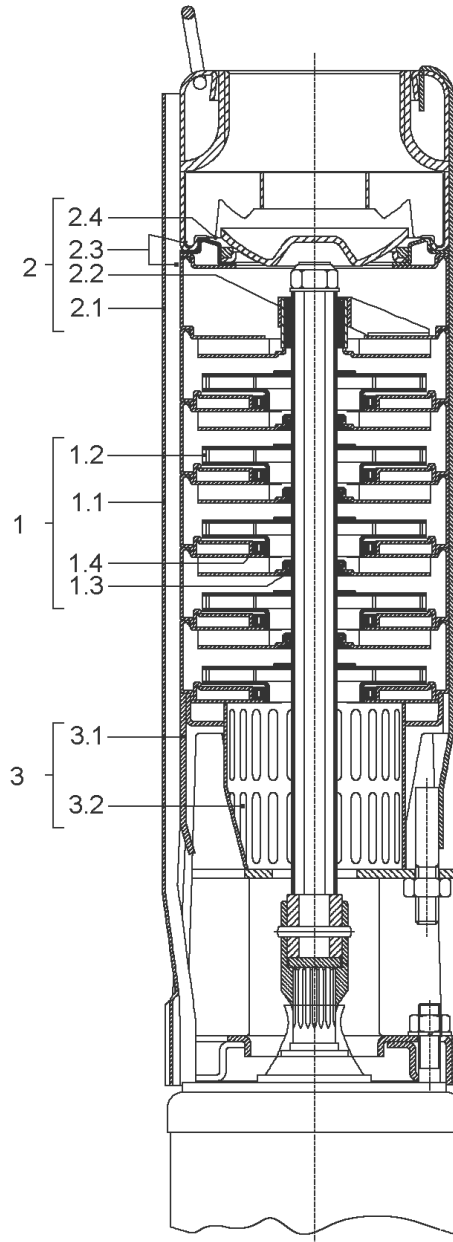

TWI4-1205-EM (4068858)

Item	Article no.	Description	Quantity
1		OTHERS STAGES KIT TWI4-12 PUMP	1
1.1		> DIFFUSER WITH RETURN GUIDE VANE	1
1.2		> PUMP IS 12 IMPELLER	1
1.3		> INTERMEDIATE BEARING	1
1.4		> NECK RING + STAINLESS STEEL PART (AISI)	1
2		SEVERE DUTY DISCHARGE KIT TWI12 PUMP	1
Note: no longer available / nicht mehr lieferbar / ne plus disponible			
3		SUCTION CASING AND STRAINER KIT TWI PUMP	1
3.1		> SUCTION INTERCONNECTOR	1
3.2		> STRAINER	1
	4003579	CAPACITOR-50MF	1

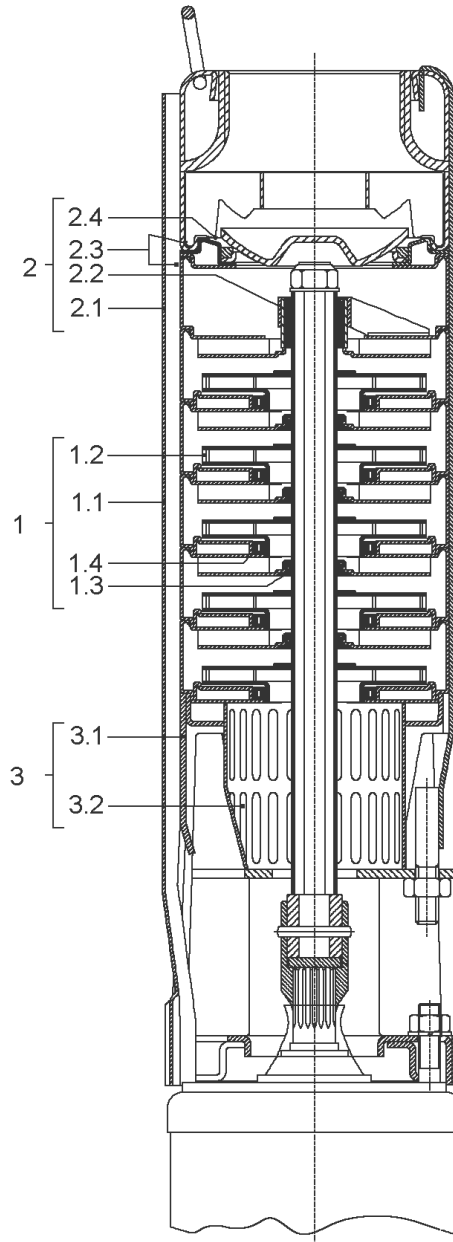

TWI4-1208-EM (4068859)

Item	Article no.	Description	Quantity
1		OTHERS STAGES KIT TWI4-12 PUMP	1
1.1		> DIFFUSER WITH RETURN GUIDE VANE	1
1.2		> PUMP IS 12 IMPELLER	1
1.3		> INTERMEDIATE BEARING	1
1.4		> NECK RING + STAINLESS STEEL PART (AISI)	1
2		SEVERE DUTY DISCHARGE KIT TWI12 PUMP	1
Note: no longer available / nicht mehr lieferbar / ne plus disponible			
3		SUCTION CASING AND STRAINER KIT TWI PUMP	1
3.1		> SUCTION INTERCONNECTOR	1
3.2		> STRAINER	1
	4080849	CAPACITOR-75 MF	1

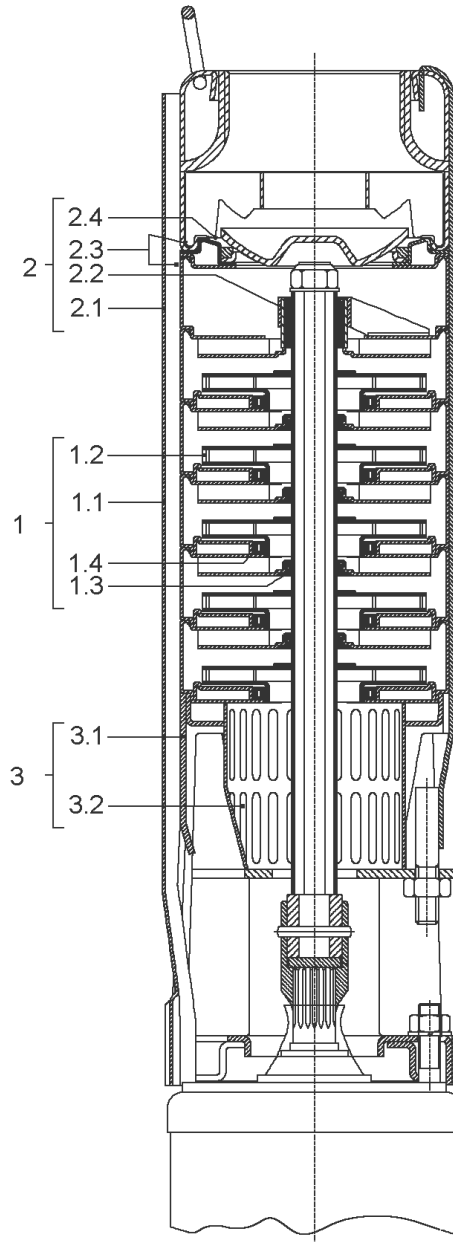

TWI4-0206-EMSC (4068865)

Item	Article no.	Description	Quantity
1		OTHERS STAGES KIT TWI4-02 PUMP	1
Note: no longer available / nicht mehrlieferbar / ne plus disponible			
1.1		> DIFFUSER WITH RETURN GUIDE VANE	1
1.2		> PUMP IS 2 IMPELLER	1
1.3		> INTERMEDIATE BEARING	1
1.4		> NECK RING + STAINLESS STEEL PART (AISI)	1
2		STANDARD CASING DISCHARGE TWI4-02 PUMP	1
Note: no longer available / nicht mehrlieferbar / ne plus disponible			
2.1		> DISCHARGE CHAMBER	1
2.2		> BEARING SPACER	1
2.3		> VALVE SEAT AND RETAINER	1
2.4		> VALVE CONE	1
3		SUCTION CASING AND STRAINER KIT TWI PUMP	1
3.1		> SUCTION INTERCONNECTOR	1
3.2		> STRAINER	1
	4063927	CAPACITOR 16µf	1

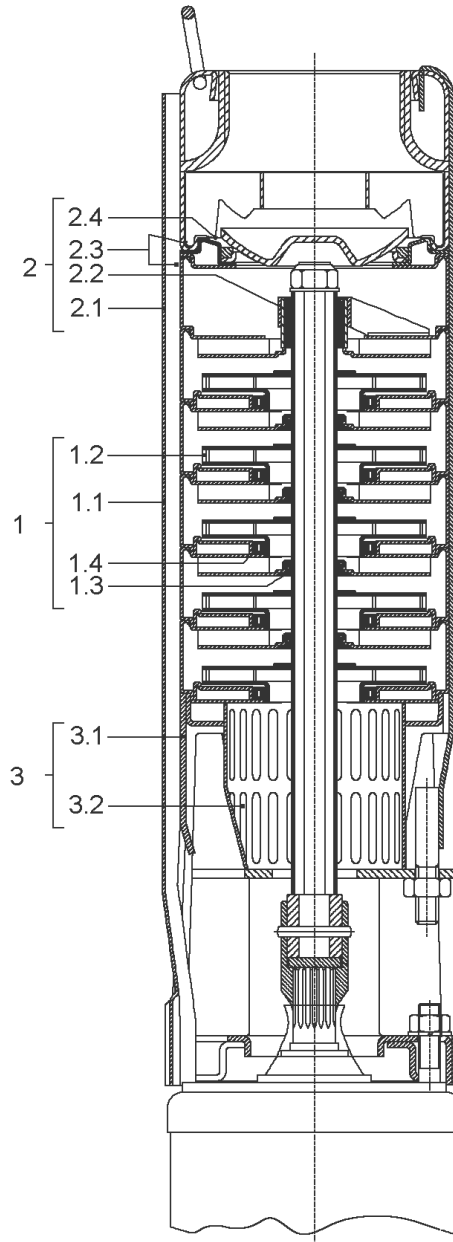

TWI4-0208-EMSC (4068866)

Item	Article no.	Description	Quantity
1		OTHERS STAGES KIT TWI4-02 PUMP	1
Note: no longer available / nicht mehr lieferbar / ne plus disponible			
1.1		> DIFFUSER WITH RETURN GUIDE VANE	1
1.2		> PUMP IS 2 IMPELLER	1
1.3		> INTERMEDIATE BEARING	1
1.4		> NECK RING + STAINLESS STEEL PART (AISI)	1
2		STANDARD CASING DISCHARGE TWI4-02 PUMP	1
Note: no longer available / nicht mehr lieferbar / ne plus disponible			
2.1		> DISCHARGE CHAMBER	1
2.2		> BEARING SPACER	1
2.3		> VALVE SEAT AND RETAINER	1
2.4		> VALVE CONE	1
3		SUCTION CASING AND STRAINER KIT TWI PUMP	1
3.1		> SUCTION INTERCONNECTOR	1
3.2		> STRAINER	1
	4063927	CAPACITOR 16µf	1



TWI4-0213-EMSC (4068867)

Item	Article no.	Description	Quantity
1		OTHERS STAGES KIT TWI4-02 PUMP	1
Note: no longer available / nicht mehrlieferbar / ne plus disponible			
1.1		> DIFFUSER WITH RETURN GUIDE VANE	1
1.2		> PUMP IS 2 IMPELLER	1
1.3		> INTERMEDIATE BEARING	1
1.4		> NECK RING + STAINLESS STEEL PART (AISI)	1
2		STANDARD CASING DISCHARGE TWI4-02 PUMP	1
Note: no longer available / nicht mehrlieferbar / ne plus disponible			
2.1		> DISCHARGE CHAMBER	1
2.2		> BEARING SPACER	1
2.3		> VALVE SEAT AND RETAINER	1
2.4		> VALVE CONE	1
3		SUCTION CASING AND STRAINER KIT TWI PUMP	1
3.1		> SUCTION INTERCONNECTOR	1
3.2		> STRAINER	1
	4003576	CAPACITOR-20MF	1

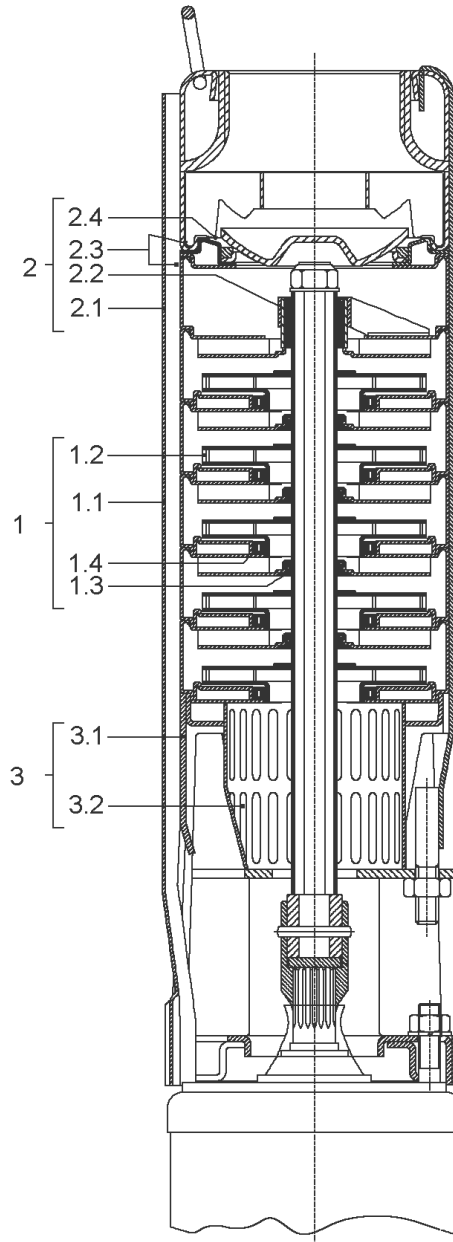

TWI4-0217-EMSC (4068868)

Item	Article no.	Description	Quantity
1		OTHERS STAGES KIT TWI4-02 PUMP	1
Note: no longer available / nicht mehr lieferbar / ne plus disponible			
1.1		> DIFFUSER WITH RETURN GUIDE VANE	1
1.2		> PUMP IS 2 IMPELLER	1
1.3		> INTERMEDIATE BEARING	1
1.4		> NECK RING + STAINLESS STEEL PART (AISI)	1
2		STANDARD CASING DISCHARGE TWI4-02 PUMP	1
Note: no longer available / nicht mehr lieferbar / ne plus disponible			
2.1		> DISCHARGE CHAMBER	1
2.2		> BEARING SPACER	1
2.3		> VALVE SEAT AND RETAINER	1
2.4		> VALVE CONE	1
3		SUCTION CASING AND STRAINER KIT TWI PUMP	1
3.1		> SUCTION INTERCONNECTOR	1
3.2		> STRAINER	1
	6083974	capacitor 30μF VP.	1

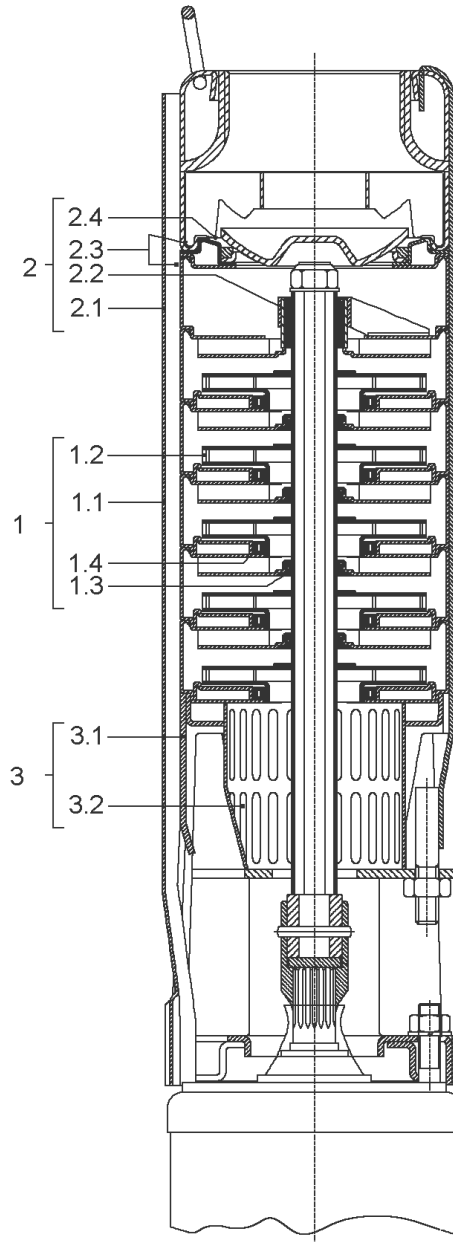

TWI4-0221-EMSC (4068869)

Item	Article no.	Description	Quantity
1		OTHERS STAGES KIT TWI4-02 PUMP	1
Note: no longer available / nicht mehrlieferbar / ne plus disponible			
1.1		> DIFFUSER WITH RETURN GUIDE VANE	1
1.2		> PUMP IS 2 IMPELLER	1
1.3		> INTERMEDIATE BEARING	1
1.4		> NECK RING + STAINLESS STEEL PART (AISI)	1
2		STANDARD CASING DISCHARGE TWI4-02 PUMP	1
Note: no longer available / nicht mehrlieferbar / ne plus disponible			
2.1		> DISCHARGE CHAMBER	1
2.2		> BEARING SPACER	1
2.3		> VALVE SEAT AND RETAINER	1
2.4		> VALVE CONE	1
3		SUCTION CASING AND STRAINER KIT TWI PUMP	1
3.1		> SUCTION INTERCONNECTOR	1
3.2		> STRAINER	1
	4003578	CAPACITOR-40MF	1

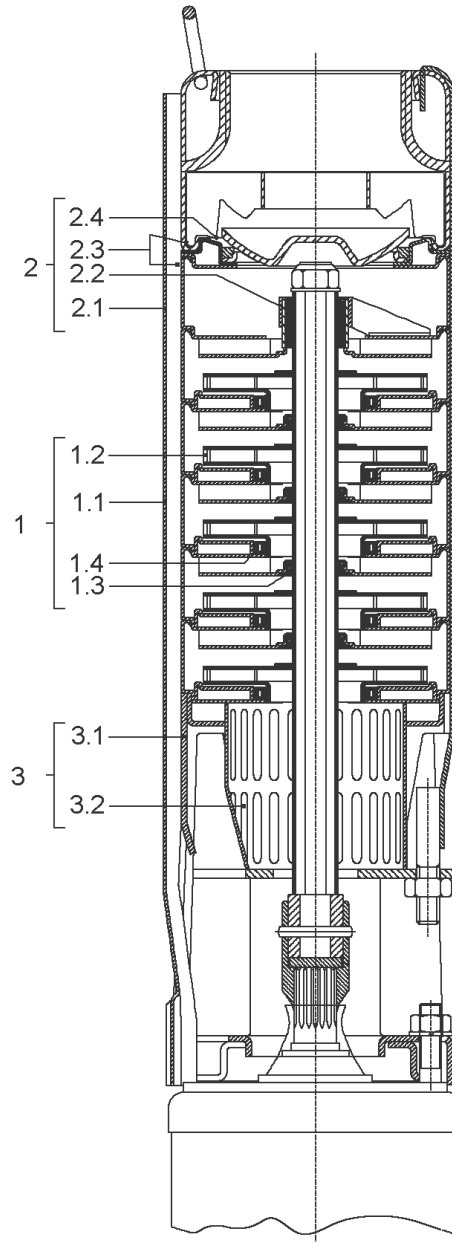

TWI4-0225-EMSC (4068870)

Item	Article no.	Description	Quantity
1		OTHERS STAGES KIT TWI4-02 PUMP	1
Note: no longer available / nicht mehrlieferbar / ne plus disponible			
1.1		> DIFFUSER WITH RETURN GUIDE VANE	1
1.2		> PUMP IS 2 IMPELLER	1
1.3		> INTERMEDIATE BEARING	1
1.4		> NECK RING + STAINLESS STEEL PART (AISI)	1
2		STANDARD CASING DISCHARGE TWI4-02 PUMP	1
Note: no longer available / nicht mehrlieferbar / ne plus disponible			
2.1		> DISCHARGE CHAMBER	1
2.2		> BEARING SPACER	1
2.3		> VALVE SEAT AND RETAINER	1
2.4		> VALVE CONE	1
3		SUCTION CASING AND STRAINER KIT TWI PUMP	1
3.1		> SUCTION INTERCONNECTOR	1
3.2		> STRAINER	1
	4003578	CAPACITOR-40MF	1

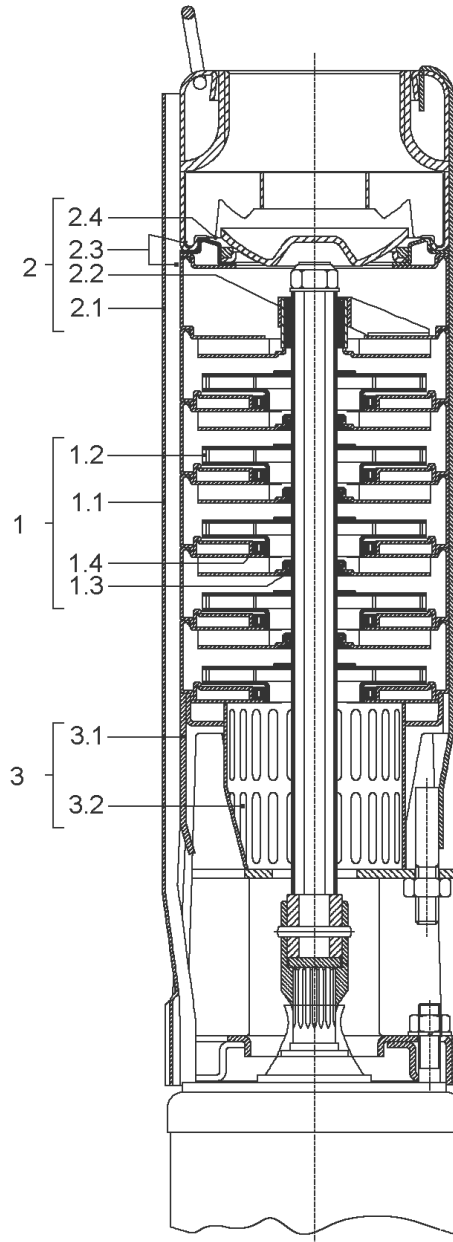

TWI4-0230-EMSC (4068871)

Item	Article no.	Description	Quantity
1		OTHERS STAGES KIT TWI4-02 PUMP	1
Note: no longer available / nicht mehrlieferbar / ne plus disponible			
1.1		> DIFFUSER WITH RETURN GUIDE VANE	1
1.2		> PUMP IS 2 IMPELLER	1
1.3		> INTERMEDIATE BEARING	1
1.4		> NECK RING + STAINLESS STEEL PART (AISI)	1
2		STANDARD CASING DISCHARGE TWI4-02 PUMP	1
Note: no longer available / nicht mehrlieferbar / ne plus disponible			
2.1		> DISCHARGE CHAMBER	1
2.2		> BEARING SPACER	1
2.3		> VALVE SEAT AND RETAINER	1
2.4		> VALVE CONE	1
3		SUCTION CASING AND STRAINER KIT TWI PUMP	1
3.1		> SUCTION INTERCONNECTOR	1
3.2		> STRAINER	1
	4003579	CAPACITOR-50MF	1

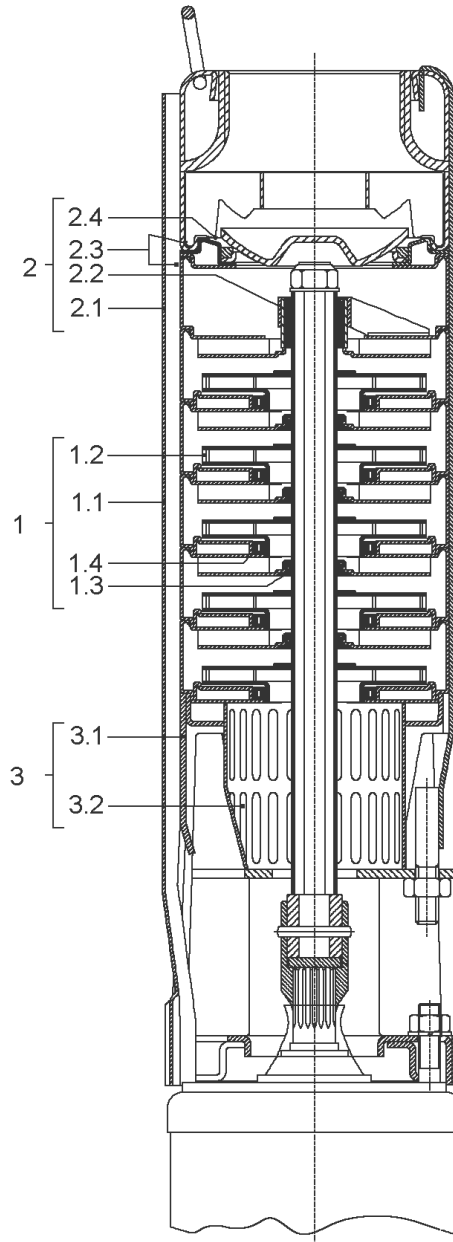

TWI4-0235-EMSC (4068872)

Item	Article no.	Description	Quantity
1		OTHERS STAGES KIT TWI4-02 PUMP	1
Note: no longer available / nicht mehrlieferbar / ne plus disponible			
1.1		> DIFFUSER WITH RETURN GUIDE VANE	1
1.2		> PUMP IS 2 IMPELLER	1
1.3		> INTERMEDIATE BEARING	1
1.4		> NECK RING + STAINLESS STEEL PART (AISI)	1
2		STANDARD CASING DISCHARGE TWI4-02 PUMP	1
Note: no longer available / nicht mehrlieferbar / ne plus disponible			
2.1		> DISCHARGE CHAMBER	1
2.2		> BEARING SPACER	1
2.3		> VALVE SEAT AND RETAINER	1
2.4		> VALVE CONE	1
3		SUCTION CASING AND STRAINER KIT TWI PUMP	1
3.1		> SUCTION INTERCONNECTOR	1
3.2		> STRAINER	1
	4003579	CAPACITOR-50MF	1

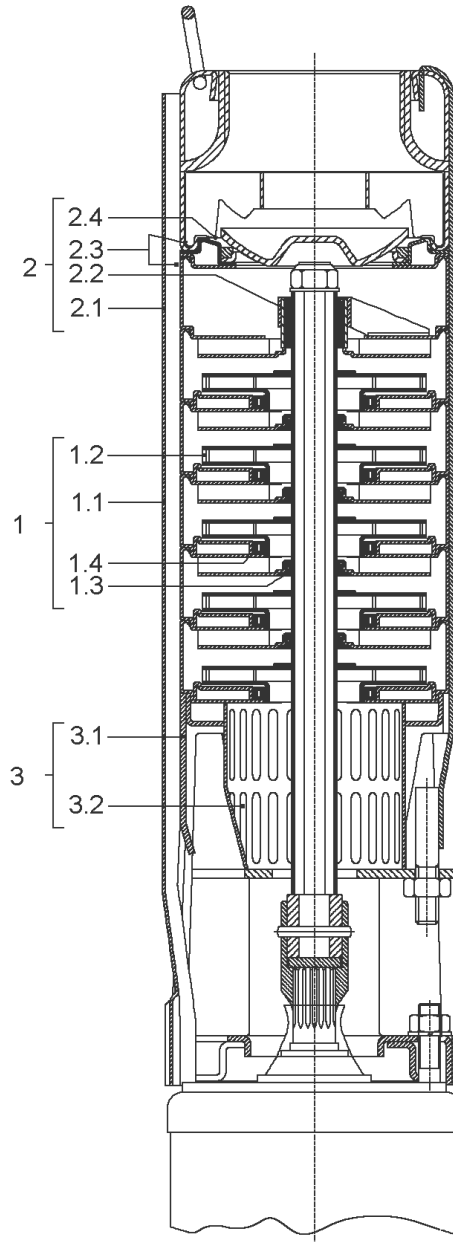

TWI4-0240-EMSC (4068873)

Item	Article no.	Description	Quantity
1		OTHERS STAGES KIT TWI4-02 PUMP	1
Note: no longer available / nicht mehr lieferbar / ne plus disponible			
1.1		> DIFFUSER WITH RETURN GUIDE VANE	1
1.2		> PUMP IS 2 IMPELLER	1
1.3		> INTERMEDIATE BEARING	1
1.4		> NECK RING + STAINLESS STEEL PART (AISI)	1
2		STANDARD CASING DISCHARGE TWI4-02 PUMP	1
Note: no longer available / nicht mehr lieferbar / ne plus disponible			
2.1		> DISCHARGE CHAMBER	1
2.2		> BEARING SPACER	1
2.3		> VALVE SEAT AND RETAINER	1
2.4		> VALVE CONE	1
3		SUCTION CASING AND STRAINER KIT TWI PUMP	1
3.1		> SUCTION INTERCONNECTOR	1
3.2		> STRAINER	1
	4080849	CAPACITOR-75 MF	1

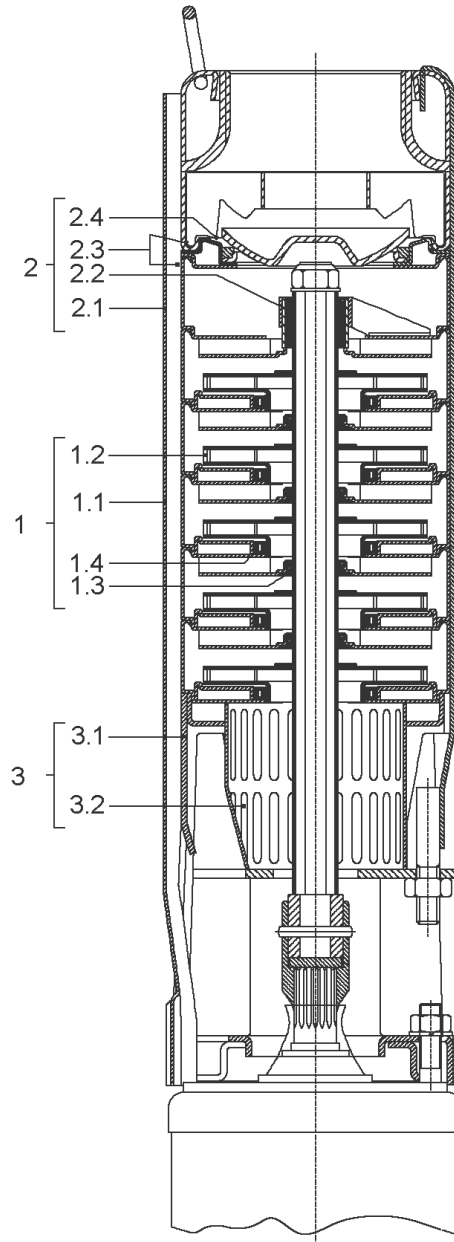

TWI4-0247-EMSC (4068874)

Item	Article no.	Description	Quantity
1		OTHERS STAGES KIT TWI4-02 PUMP	1
Note: no longer available / nicht mehr lieferbar / ne plus disponible			
1.1		> DIFFUSER WITH RETURN GUIDE VANE	1
1.2		> PUMP IS 2 IMPELLER	1
1.3		> INTERMEDIATE BEARING	1
1.4		> NECK RING + STAINLESS STEEL PART (AISI)	1
2		STANDARD CASING DISCHARGE TWI4-02 PUMP	1
Note: no longer available / nicht mehr lieferbar / ne plus disponible			
2.1		> DISCHARGE CHAMBER	1
2.2		> BEARING SPACER	1
2.3		> VALVE SEAT AND RETAINER	1
2.4		> VALVE CONE	1
3		SUCTION CASING AND STRAINER KIT TWI PUMP	1
3.1		> SUCTION INTERCONNECTOR	1
3.2		> STRAINER	1
	4080849	CAPACITOR-75 MF	1

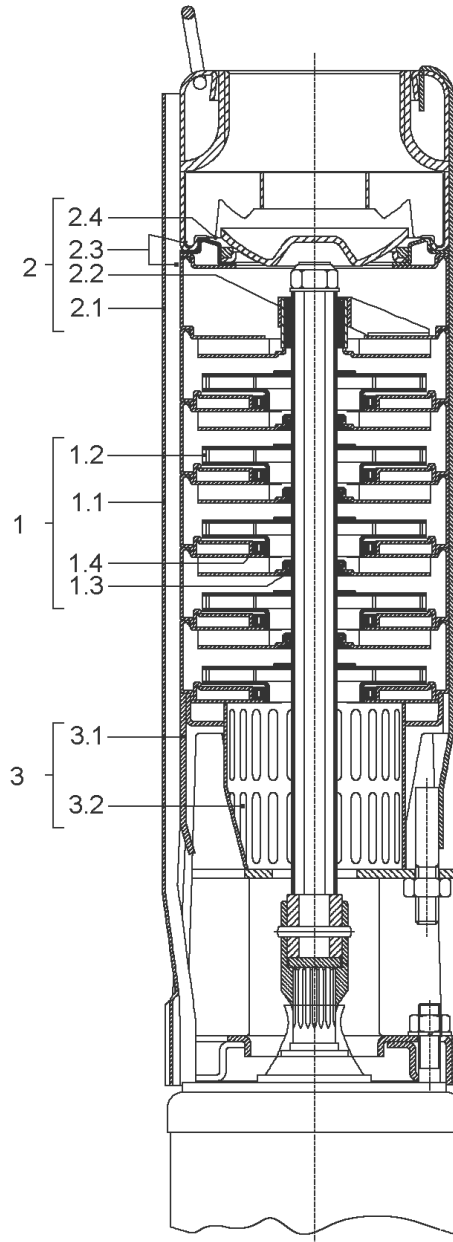

TWI4-0254-EMSC (4068875)

Item	Article no.	Description	Quantity
1		OTHERS STAGES KIT TWI4-02 PUMP	1
Note: no longer available / nicht mehr lieferbar / ne plus disponible			
1.1		> DIFFUSER WITH RETURN GUIDE VANE	1
1.2		> PUMP IS 2 IMPELLER	1
1.3		> INTERMEDIATE BEARING	1
1.4		> NECK RING + STAINLESS STEEL PART (AISI)	1
2		STANDARD CASING DISCHARGE TWI4-02 PUMP	1
Note: no longer available / nicht mehr lieferbar / ne plus disponible			
2.1		> DISCHARGE CHAMBER	1
2.2		> BEARING SPACER	1
2.3		> VALVE SEAT AND RETAINER	1
2.4		> VALVE CONE	1
3		SUCTION CASING AND STRAINER KIT TWI PUMP	1
3.1		> SUCTION INTERCONNECTOR	1
3.2		> STRAINER	1
	4080849	CAPACITOR-75 MF	1

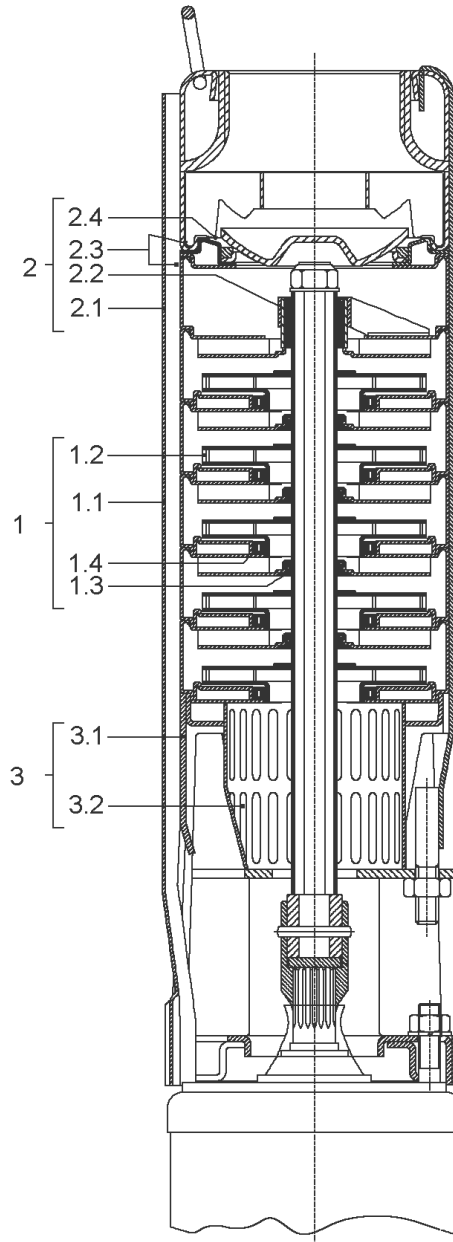

TWI4-0306-EMSC (4068876)

Item	Article no.	Description	Quantity
1		OTHERS STAGES KIT TWI4-03 PUMP	1
1.1		> DIFFUSER WITH RETURN GUIDE VANE	1
1.2		> PUMP IS 3 IMPELLER	1
1.3		> INTERMEDIATE BEARING	1
1.4		> NECK RING + STAINLESS STEEL PART (AISI)	1
2		SEVERE DUTY DISCHARGE KIT TWI4-03 PUMP	1
Note: no longer available / nicht mehr lieferbar / ne plus disponible			
2.1		> SEVERE DUTY DISCHARGE CHAMBER	1
2.2		> BEARING SPACER	1
3		SUCTION CASING AND STRAINER KIT TWI PUMP	1
3.1		> SUCTION INTERCONNECTOR	1
3.2		> STRAINER	1
	4063927	CAPACITOR 16µf	1

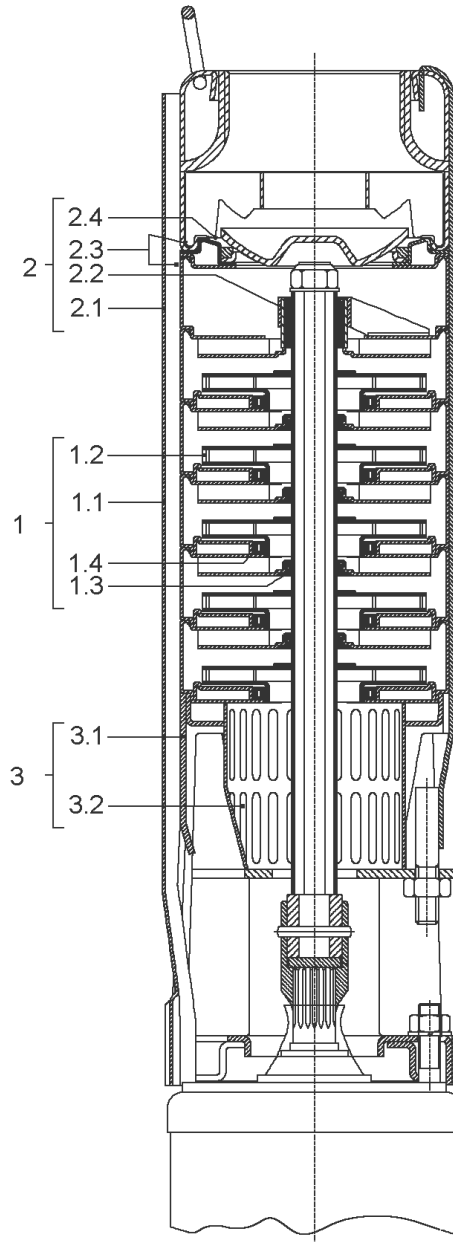

TWI4-0309-EMSC (4068877)

Item	Article no.	Description	Quantity
1		OTHERS STAGES KIT TWI4-03 PUMP	1
1.1		> DIFFUSER WITH RETURN GUIDE VANE	1
1.2		> PUMP IS 3 IMPELLER	1
1.3		> INTERMEDIATE BEARING	1
1.4		> NECK RING + STAINLESS STEEL PART (AISI)	1
2		SEVERE DUTY DISCHARGE KIT TWI4-03 PUMP	1
Note: no longer available / nicht mehr lieferbar / ne plus disponible			
2.1		> SEVERE DUTY DISCHARGE CHAMBER	1
2.2		> BEARING SPACER	1
3		SUCTION CASING AND STRAINER KIT TWI PUMP	1
3.1		> SUCTION INTERCONNECTOR	1
3.2		> STRAINER	1
	4003576	CAPACITOR-20MF	1

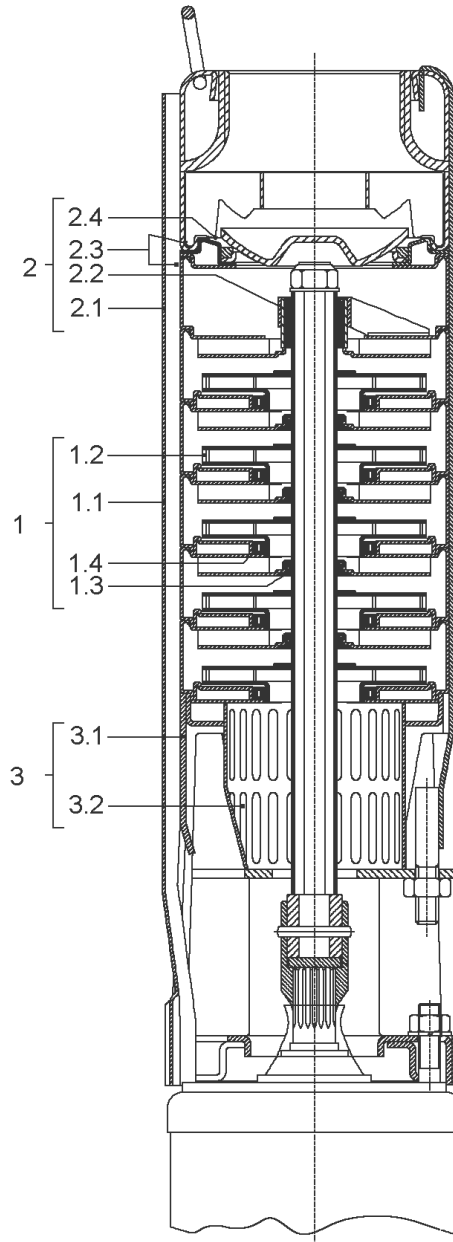

TWI4-0312-EMSC (4068878)

Item	Article no.	Description	Quantity
1		OTHERS STAGES KIT TWI4-03 PUMP	1
1.1		> DIFFUSER WITH RETURN GUIDE VANE	1
1.2		> PUMP IS 3 IMPELLER	1
1.3		> INTERMEDIATE BEARING	1
1.4		> NECK RING + STAINLESS STEEL PART (AISI)	1
2		SEVERE DUTY DISCHARGE KIT TWI4-03 PUMP	1
Note: no longer available / nicht mehr lieferbar / ne plus disponible			
2.1		> SEVERE DUTY DISCHARGE CHAMBER	1
2.2		> BEARING SPACER	1
3		SUCTION CASING AND STRAINER KIT TWI PUMP	1
3.1		> SUCTION INTERCONNECTOR	1
3.2		> STRAINER	1
	6083974	capacitor 30μF VP.	1

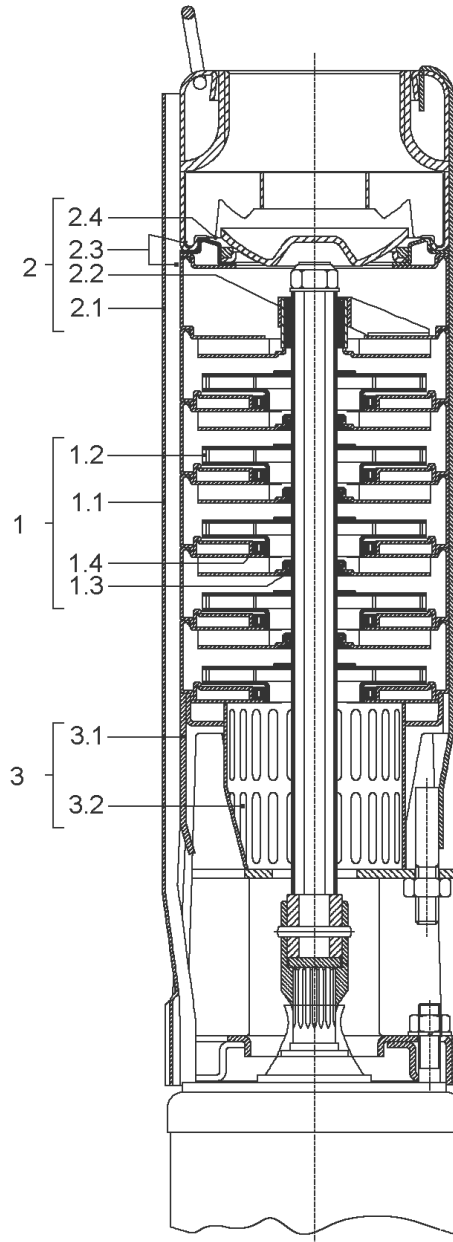

TWI4-0315-EMSC (4068879)

Item	Article no.	Description	Quantity
1		OTHERS STAGES KIT TWI4-03 PUMP	1
1.1		> DIFFUSER WITH RETURN GUIDE VANE	1
1.2		> PUMP IS 3 IMPELLER	1
1.3		> INTERMEDIATE BEARING	1
1.4		> NECK RING + STAINLESS STEEL PART (AISI)	1
2		SEVERE DUTY DISCHARGE KIT TWI4-03 PUMP	1
Note: no longer available / nicht mehr lieferbar / ne plus disponible			
2.1		> SEVERE DUTY DISCHARGE CHAMBER	1
2.2		> BEARING SPACER	1
3		SUCTION CASING AND STRAINER KIT TWI PUMP	1
3.1		> SUCTION INTERCONNECTOR	1
3.2		> STRAINER	1
	4003578	CAPACITOR-40MF	1

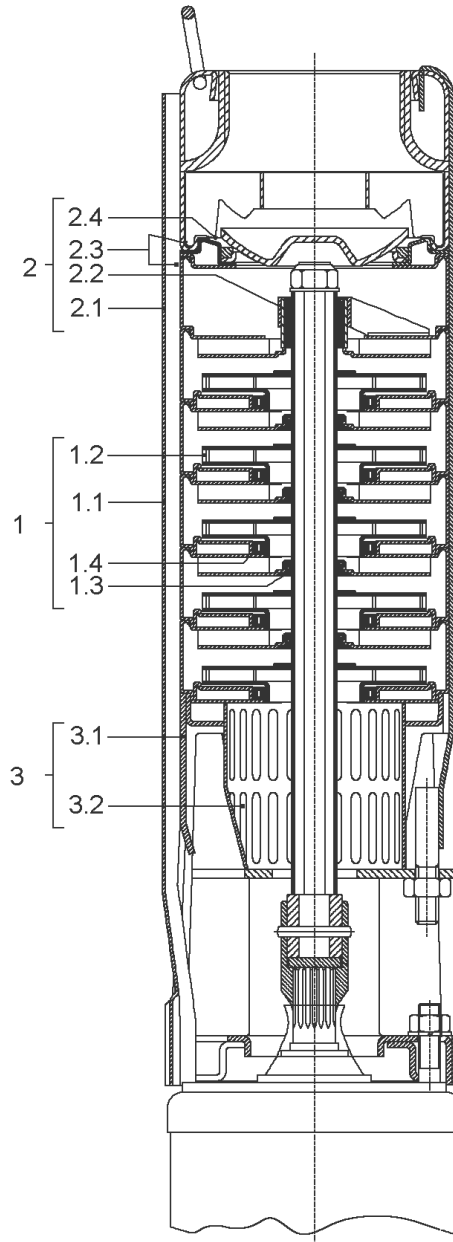

TWI4-0318-EMSC (4068880)

Item	Article no.	Description	Quantity
1		OTHERS STAGES KIT TWI4-03 PUMP	1
1.1		> DIFFUSER WITH RETURN GUIDE VANE	1
1.2		> PUMP IS 3 IMPELLER	1
1.3		> INTERMEDIATE BEARING	1
1.4		> NECK RING + STAINLESS STEEL PART (AISI)	1
2		SEVERE DUTY DISCHARGE KIT TWI4-03 PUMP	1
Note: no longer available / nicht mehr lieferbar / ne plus disponible			
2.1		> SEVERE DUTY DISCHARGE CHAMBER	1
2.2		> BEARING SPACER	1
3		SUCTION CASING AND STRAINER KIT TWI PUMP	1
3.1		> SUCTION INTERCONNECTOR	1
3.2		> STRAINER	1
	4003578	CAPACITOR-40MF	1

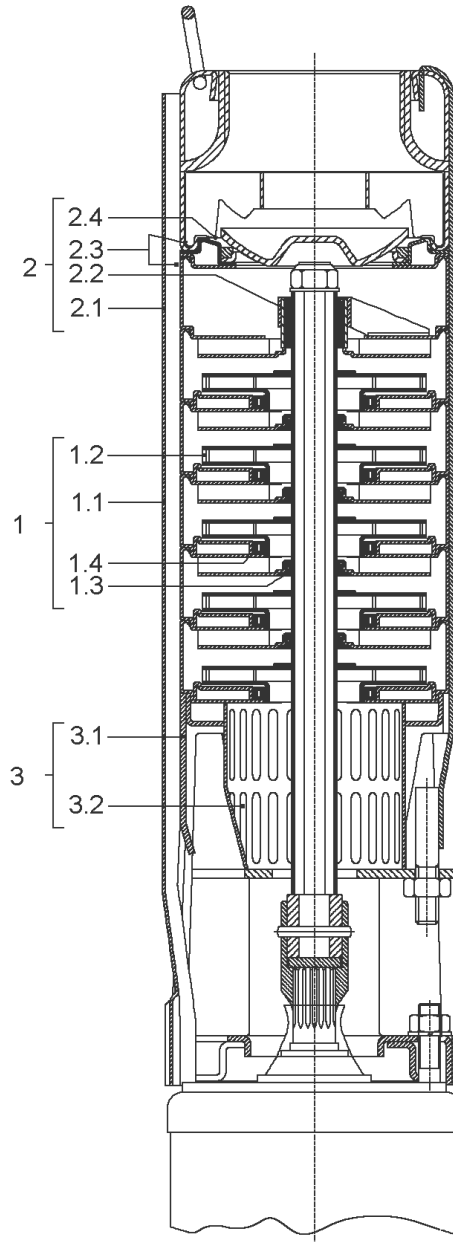

TWI4-0322-EMSC (4068881)

Item	Article no.	Description	Quantity
1		OTHERS STAGES KIT TWI4-03 PUMP	1
1.1		> DIFFUSER WITH RETURN GUIDE VANE	1
1.2		> PUMP IS 3 IMPELLER	1
1.3		> INTERMEDIATE BEARING	1
1.4		> NECK RING + STAINLESS STEEL PART (AISI)	1
2		SEVERE DUTY DISCHARGE KIT TWI4-03 PUMP	1
Note: no longer available / nicht mehr lieferbar / ne plus disponible			
2.1		> SEVERE DUTY DISCHARGE CHAMBER	1
2.2		> BEARING SPACER	1
3		SUCTION CASING AND STRAINER KIT TWI PUMP	1
3.1		> SUCTION INTERCONNECTOR	1
3.2		> STRAINER	1
	4003579	CAPACITOR-50MF	1

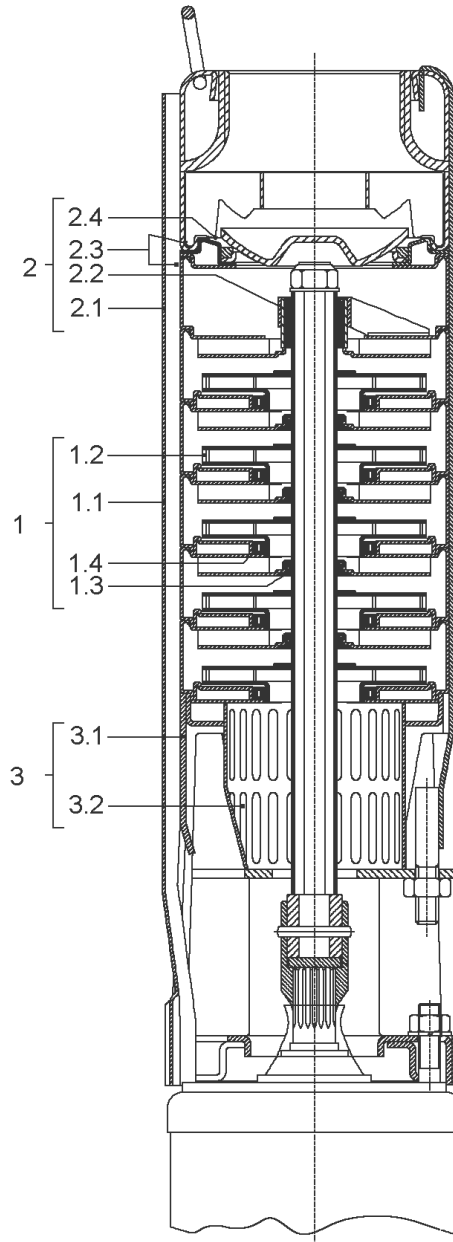

TWI4-0325-EMSC (4068882)

Item	Article no.	Description	Quantity
1		OTHERS STAGES KIT TWI4-03 PUMP	1
1.1		> DIFFUSER WITH RETURN GUIDE VANE	1
1.2		> PUMP IS 3 IMPELLER	1
1.3		> INTERMEDIATE BEARING	1
1.4		> NECK RING + STAINLESS STEEL PART (AISI)	1
2		SEVERE DUTY DISCHARGE KIT TWI4-03 PUMP	1
Note: no longer available / nicht mehr lieferbar / ne plus disponible			
2.1		> SEVERE DUTY DISCHARGE CHAMBER	1
2.2		> BEARING SPACER	1
3		SUCTION CASING AND STRAINER KIT TWI PUMP	1
3.1		> SUCTION INTERCONNECTOR	1
3.2		> STRAINER	1
	4003579	CAPACITOR-50MF	1

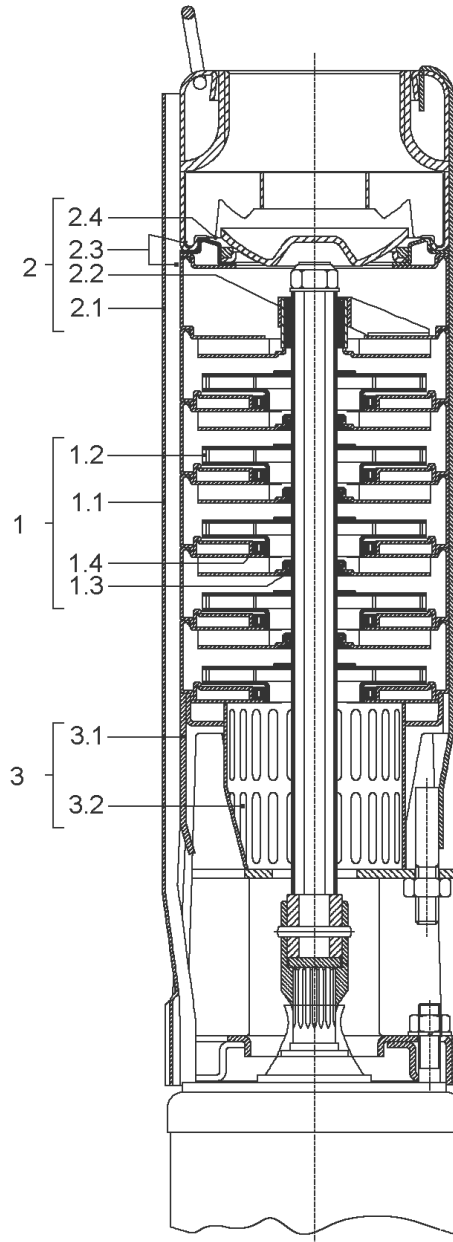

TWI4-0330-EMSC (4068883)

Item	Article no.	Description	Quantity
1		OTHERS STAGES KIT TWI4-03 PUMP	1
1.1		> DIFFUSER WITH RETURN GUIDE VANE	1
1.2		> PUMP IS 3 IMPELLER	1
1.3		> INTERMEDIATE BEARING	1
1.4		> NECK RING + STAINLESS STEEL PART (AISI)	1
2		SEVERE DUTY DISCHARGE KIT TWI4-03 PUMP	1
Note: no longer available / nicht mehr lieferbar / ne plus disponible			
2.1		> SEVERE DUTY DISCHARGE CHAMBER	1
2.2		> BEARING SPACER	1
3		SUCTION CASING AND STRAINER KIT TWI PUMP	1
3.1		> SUCTION INTERCONNECTOR	1
3.2		> STRAINER	1
	4080849	CAPACITOR-75 MF	1



TWI4-0336-EMSC (4068884)

Item	Article no.	Description	Quantity
1		OTHERS STAGES KIT TWI4-03 PUMP	1
1.1		> DIFFUSER WITH RETURN GUIDE VANE	1
1.2		> PUMP IS 3 IMPELLER	1
1.3		> INTERMEDIATE BEARING	1
1.4		> NECK RING + STAINLESS STEEL PART (AISI)	1
2		SEVERE DUTY DISCHARGE KIT TWI4-03 PUMP	1
Note: no longer available / nicht mehr lieferbar / ne plus disponible			
2.1		> SEVERE DUTY DISCHARGE CHAMBER	1
2.2		> BEARING SPACER	1
3		SUCTION CASING AND STRAINER KIT TWI PUMP	1
3.1		> SUCTION INTERCONNECTOR	1
3.2		> STRAINER	1
	4080849	CAPACITOR-75 MF	1

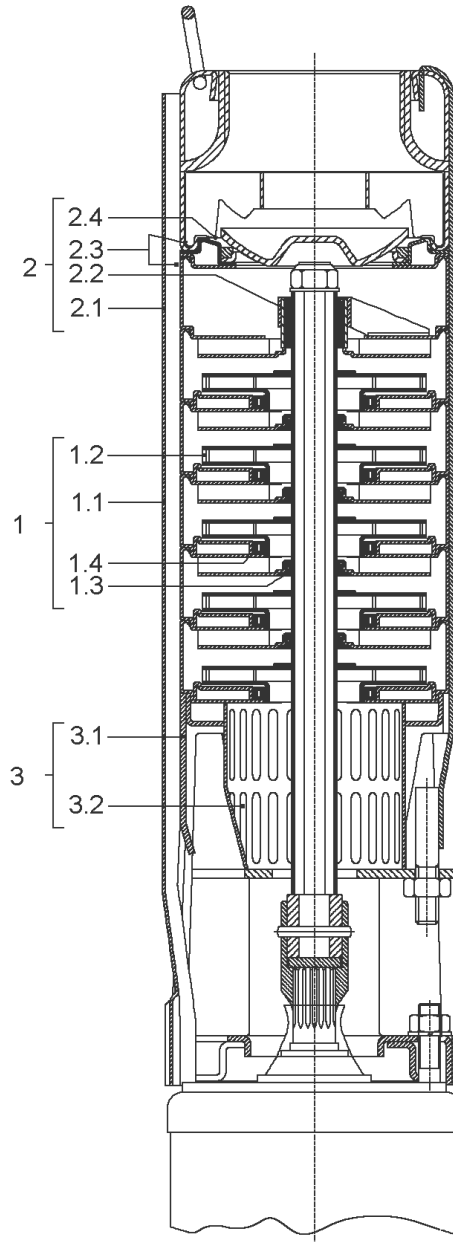

TWI4-0404-EMSC (4068885)

Item	Article no.	Description	Quantity
1		OTHERS STAGES KIT TWI4-04 PUMP	1
1.1		> DIFFUSER WITH RETURN GUIDE VANE	1
1.2		> PUMP IS 4 IMPELLER	1
1.3		> INTERMEDIATE BEARING	1
1.4		> NECK RING + STAINLESS STEEL PART (AISI)	1
2		SEVERE DUTY DISCHARGE KIT TWI4-04 PUMP	1
Note: no longer available / nicht mehr lieferbar / ne plus disponible			
2.1		> SEVERE DUTY DISCHARGE CHAMBER	1
2.2		> BEARING SPACER	1
3		SUCTION CASING AND STRAINER KIT TWI PUMP	1
3.1		> SUCTION INTERCONNECTOR	1
3.2		> STRAINER	1
	4063927	CAPACITOR 16µf	1

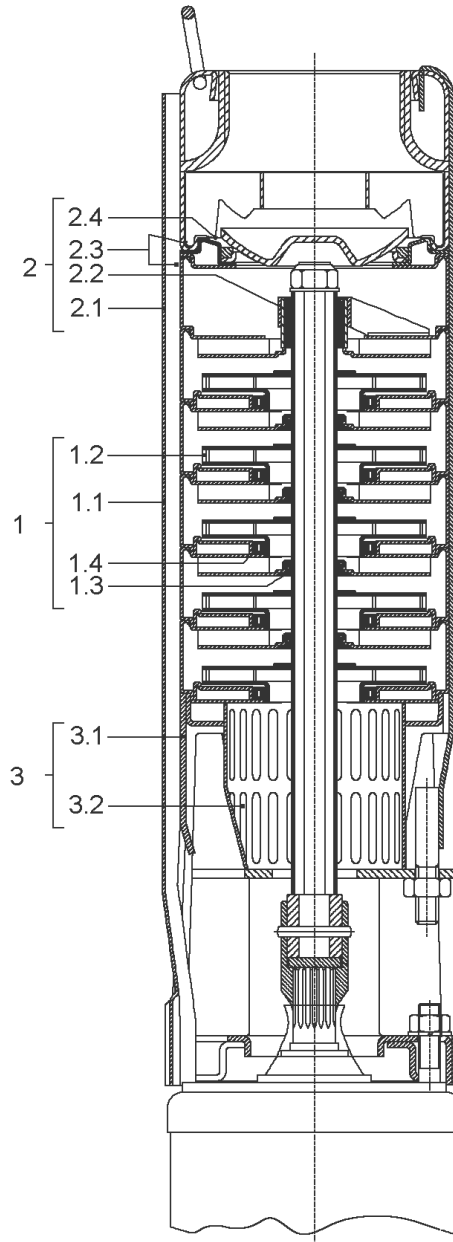

TWI4-0407-EMSC (4068886)

Item	Article no.	Description	Quantity
1		OTHERS STAGES KIT TWI4-04 PUMP	1
1.1		> DIFFUSER WITH RETURN GUIDE VANE	1
1.2		> PUMP IS 4 IMPELLER	1
1.3		> INTERMEDIATE BEARING	1
1.4		> NECK RING + STAINLESS STEEL PART (AISI)	1
2		SEVERE DUTY DISCHARGE KIT TWI4-04 PUMP	1
Note: no longer available / nicht mehr lieferbar / ne plus disponible			
2.1		> SEVERE DUTY DISCHARGE CHAMBER	1
2.2		> BEARING SPACER	1
3		SUCTION CASING AND STRAINER KIT TWI PUMP	1
3.1		> SUCTION INTERCONNECTOR	1
3.2		> STRAINER	1
	4003576	CAPACITOR-20MF	1

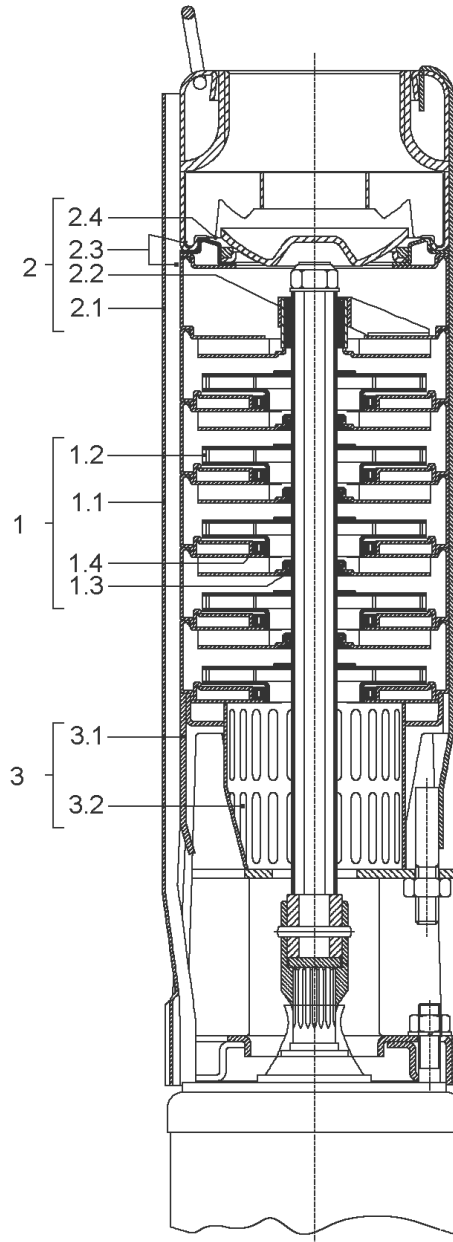

TWI4-0409-EMSC (4068887)

Item	Article no.	Description	Quantity
1		OTHERS STAGES KIT TWI4-04 PUMP	1
1.1		> DIFFUSER WITH RETURN GUIDE VANE	1
1.2		> PUMP IS 4 IMPELLER	1
1.3		> INTERMEDIATE BEARING	1
1.4		> NECK RING + STAINLESS STEEL PART (AISI)	1
2		SEVERE DUTY DISCHARGE KIT TWI4-04 PUMP	1
Note: no longer available / nicht mehr lieferbar / ne plus disponible			
2.1		> SEVERE DUTY DISCHARGE CHAMBER	1
2.2		> BEARING SPACER	1
3		SUCTION CASING AND STRAINER KIT TWI PUMP	1
3.1		> SUCTION INTERCONNECTOR	1
3.2		> STRAINER	1
	6083974	capacitor 30μF VP.	1

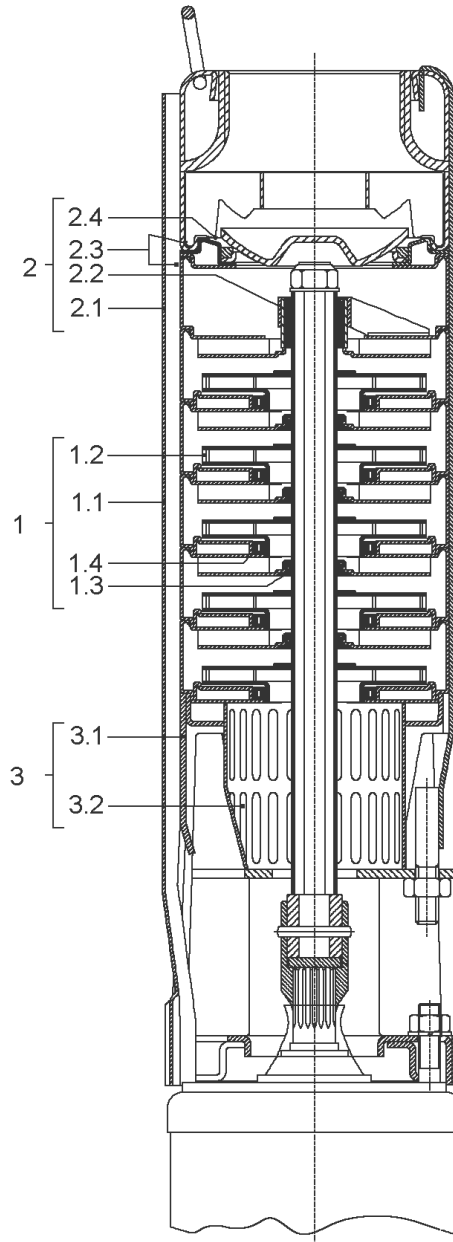

TWI4-0414-EMSC (4068888)

Item	Article no.	Description	Quantity
1		OTHERS STAGES KIT TWI4-04 PUMP	1
1.1		> DIFFUSER WITH RETURN GUIDE VANE	1
1.2		> PUMP IS 4 IMPELLER	1
1.3		> INTERMEDIATE BEARING	1
1.4		> NECK RING + STAINLESS STEEL PART (AISI)	1
2		SEVERE DUTY DISCHARGE KIT TWI4-04 PUMP	1
Note: no longer available / nicht mehr lieferbar / ne plus disponible			
2.1		> SEVERE DUTY DISCHARGE CHAMBER	1
2.2		> BEARING SPACER	1
3		SUCTION CASING AND STRAINER KIT TWI PUMP	1
3.1		> SUCTION INTERCONNECTOR	1
3.2		> STRAINER	1
	4003578	CAPACITOR-40MF	1

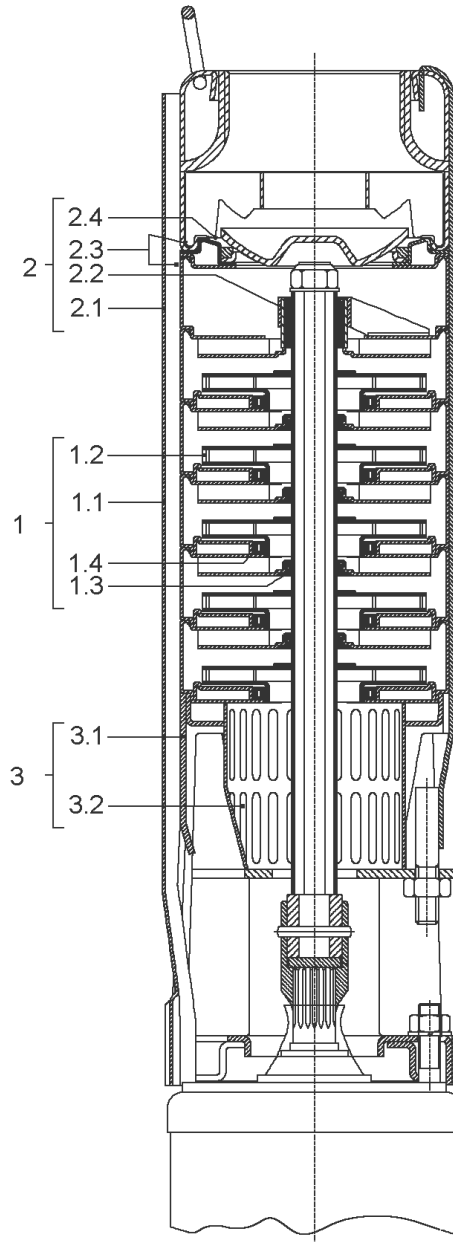

TWI4-0419-EMSC (4068889)

Item	Article no.	Description	Quantity
1		OTHERS STAGES KIT TWI4-04 PUMP	1
1.1		> DIFFUSER WITH RETURN GUIDE VANE	1
1.2		> PUMP IS 4 IMPELLER	1
1.3		> INTERMEDIATE BEARING	1
1.4		> NECK RING + STAINLESS STEEL PART (AISI)	1
2		SEVERE DUTY DISCHARGE KIT TWI4-04 PUMP	1
Note: no longer available / nicht mehr lieferbar / ne plus disponible			
2.1		> SEVERE DUTY DISCHARGE CHAMBER	1
2.2		> BEARING SPACER	1
3		SUCTION CASING AND STRAINER KIT TWI PUMP	1
3.1		> SUCTION INTERCONNECTOR	1
3.2		> STRAINER	1
	4003579	CAPACITOR-50MF	1

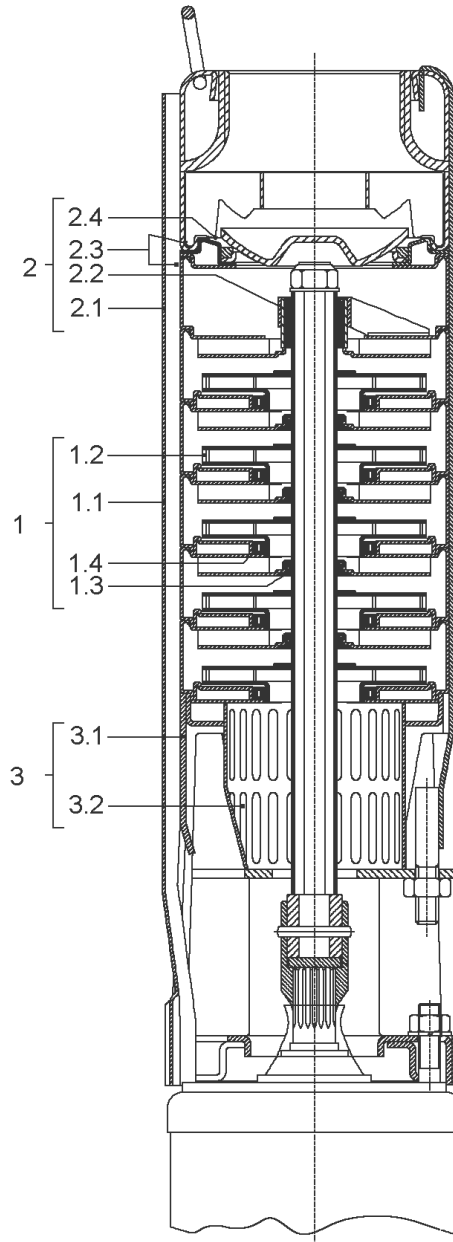

TWI4-0424-EMSC (4068890)

Item	Article no.	Description	Quantity
1		OTHERS STAGES KIT TWI4-04 PUMP	1
1.1		> DIFFUSER WITH RETURN GUIDE VANE	1
1.2		> PUMP IS 4 IMPELLER	1
1.3		> INTERMEDIATE BEARING	1
1.4		> NECK RING + STAINLESS STEEL PART (AISI)	1
2		SEVERE DUTY DISCHARGE KIT TWI4-04 PUMP	1
Note: no longer available / nicht mehr lieferbar / ne plus disponible			
2.1		> SEVERE DUTY DISCHARGE CHAMBER	1
2.2		> BEARING SPACER	1
3		SUCTION CASING AND STRAINER KIT TWI PUMP	1
3.1		> SUCTION INTERCONNECTOR	1
3.2		> STRAINER	1
	4080849	CAPACITOR-75 MF	1

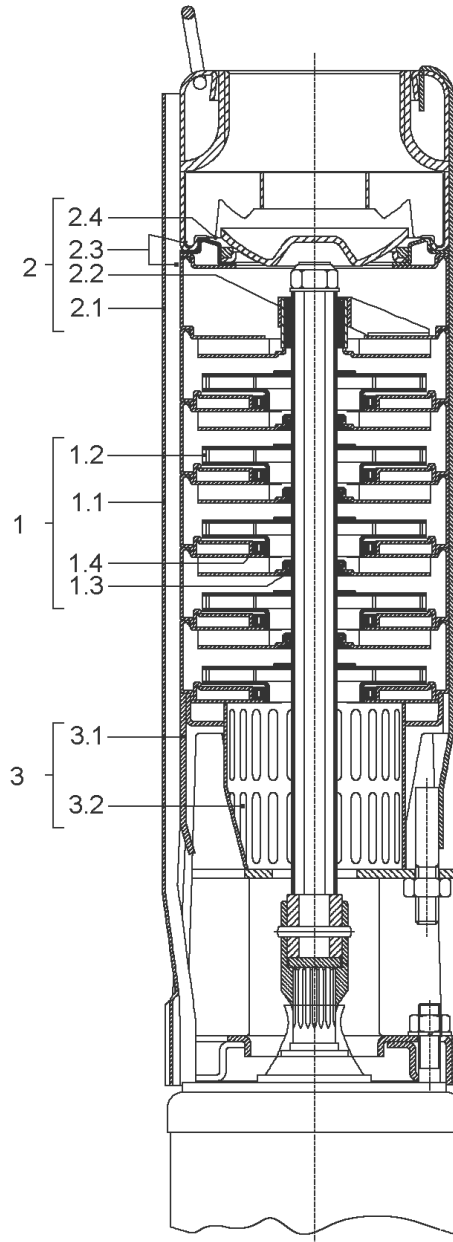

TWI4-0429-EMSC (4068891)

Item	Article no.	Description	Quantity
1		OTHERS STAGES KIT TWI4-04 PUMP	1
1.1		> DIFFUSER WITH RETURN GUIDE VANE	1
1.2		> PUMP IS 4 IMPELLER	1
1.3		> INTERMEDIATE BEARING	1
1.4		> NECK RING + STAINLESS STEEL PART (AISI)	1
2		SEVERE DUTY DISCHARGE KIT TWI4-04 PUMP	1
Note: no longer available / nicht mehr lieferbar / ne plus disponible			
2.1		> SEVERE DUTY DISCHARGE CHAMBER	1
2.2		> BEARING SPACER	1
3		SUCTION CASING AND STRAINER KIT TWI PUMP	1
3.1		> SUCTION INTERCONNECTOR	1
3.2		> STRAINER	1
	4080849	CAPACITOR-75 MF	1

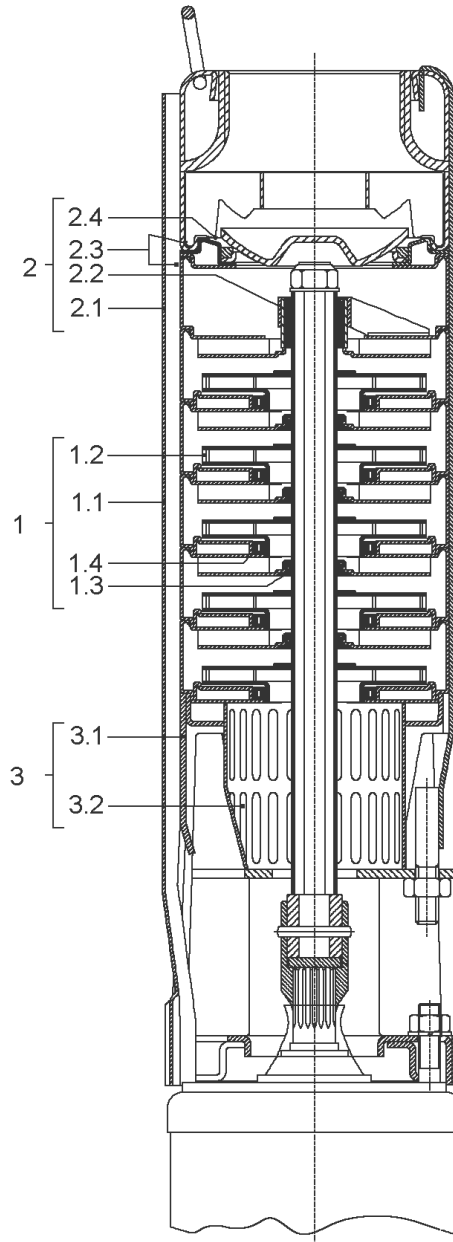

TWI4-0703-EMSC (4068892)

Item	Article no.	Description	Quantity
1		OTHERS STAGES KIT TWI4-07 PUMP	1
1.1		> DIFFUSER WITH RETURN GUIDE VANE	1
1.2		> PUMP IS 7 IMPELLER	1
1.3		> INTERMEDIATE BEARING	1
1.4		> NECK RING + STAINLESS STEEL PART (AISI)	1
2		SEVERE DUTY DISCHARGE KIT TWI4-07 PUMP	1
Note: no longer available / nicht mehr lieferbar / ne plus disponible			
2.1		> SEVERE DUTY DISCHARGE CHAMBER	1
2.2		> BEARING SPACER	1
3		SUCTION CASING AND STRAINER KIT TWI PUMP	1
3.1		> SUCTION INTERCONNECTOR	1
3.2		> STRAINER	1
	4063927	CAPACITOR 16µf	1

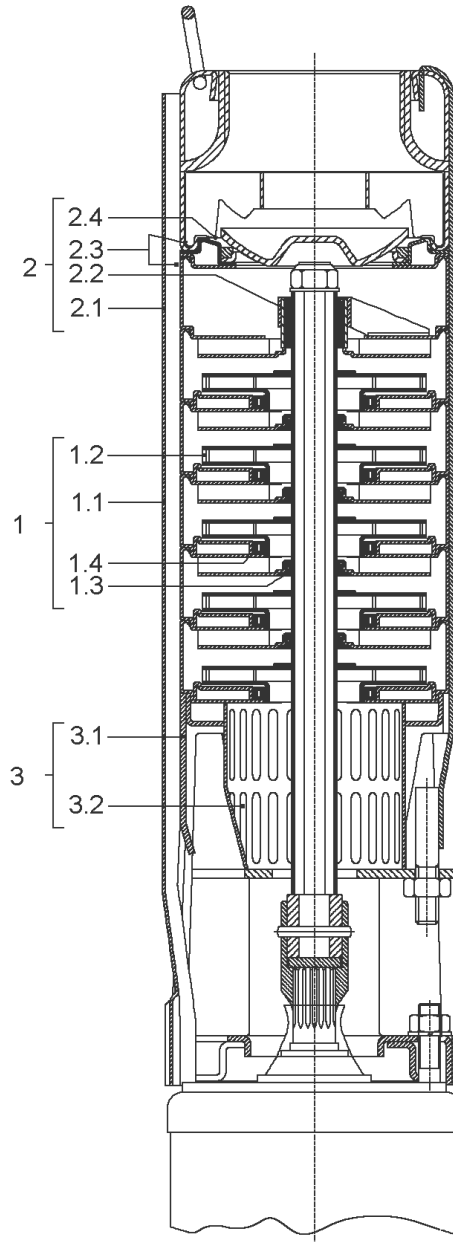

TWI4-0704-EMSC (4068893)

Item	Article no.	Description	Quantity
1		OTHERS STAGES KIT TWI4-07 PUMP	1
1.1		> DIFFUSER WITH RETURN GUIDE VANE	1
1.2		> PUMP IS 7 IMPELLER	1
1.3		> INTERMEDIATE BEARING	1
1.4		> NECK RING + STAINLESS STEEL PART (AISI)	1
2		SEVERE DUTY DISCHARGE KIT TWI4-07 PUMP	1
Note: no longer available / nicht mehr lieferbar / ne plus disponible			
2.1		> SEVERE DUTY DISCHARGE CHAMBER	1
2.2		> BEARING SPACER	1
3		SUCTION CASING AND STRAINER KIT TWI PUMP	1
3.1		> SUCTION INTERCONNECTOR	1
3.2		> STRAINER	1
	4003576	CAPACITOR-20MF	1

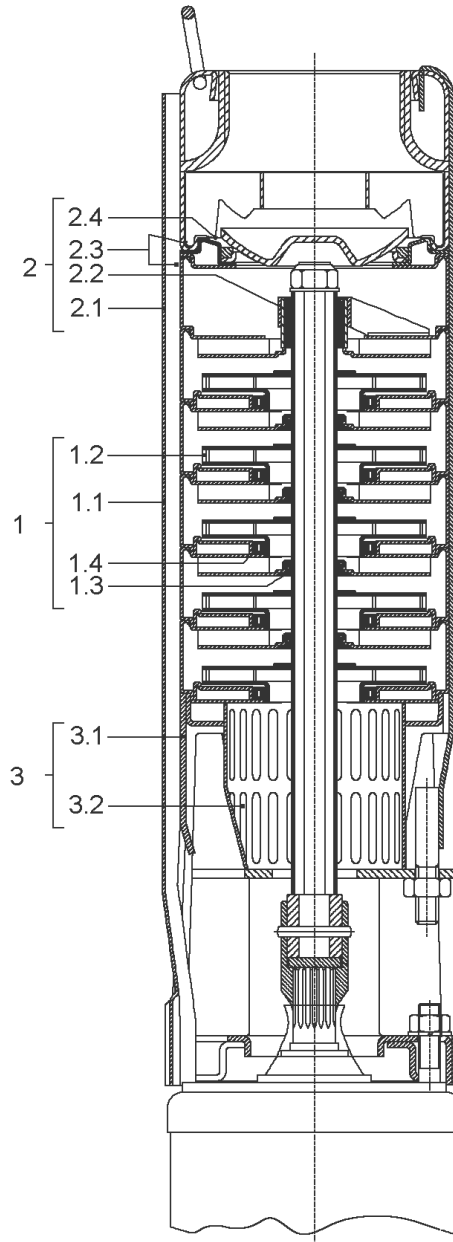

TWI4-0706-EMSC (4068894)

Item	Article no.	Description	Quantity
1		OTHERS STAGES KIT TWI4-07 PUMP	1
1.1		> DIFFUSER WITH RETURN GUIDE VANE	1
1.2		> PUMP IS 7 IMPELLER	1
1.3		> INTERMEDIATE BEARING	1
1.4		> NECK RING + STAINLESS STEEL PART (AISI)	1
2		SEVERE DUTY DISCHARGE KIT TWI4-07 PUMP	1
Note: no longer available / nicht mehrlieferbar / ne plus disponible			
2.1		> SEVERE DUTY DISCHARGE CHAMBER	1
2.2		> BEARING SPACER	1
3		SUCTION CASING AND STRAINER KIT TWI PUMP	1
3.1		> SUCTION INTERCONNECTOR	1
3.2		> STRAINER	1
	6083974	capacitor 30μF VP.	1



TWI4-0709EMSC (4068895)

Item	Article no.	Description	Quantity
1		OTHERS STAGES KIT TWI4-07 PUMP	1
1.1		> DIFFUSER WITH RETURN GUIDE VANE	1
1.2		> PUMP IS 7 IMPELLER	1
1.3		> INTERMEDIATE BEARING	1
1.4		> NECK RING + STAINLESS STEEL PART (AISI)	1
2		SEVERE DUTY DISCHARGE KIT TWI4-07 PUMP	1
Note: no longer available / nicht mehr lieferbar / ne plus disponible			
2.1		> SEVERE DUTY DISCHARGE CHAMBER	1
2.2		> BEARING SPACER	1
3		SUCTION CASING AND STRAINER KIT TWI PUMP	1
3.1		> SUCTION INTERCONNECTOR	1
3.2		> STRAINER	1
	4003578	CAPACITOR-40MF	1

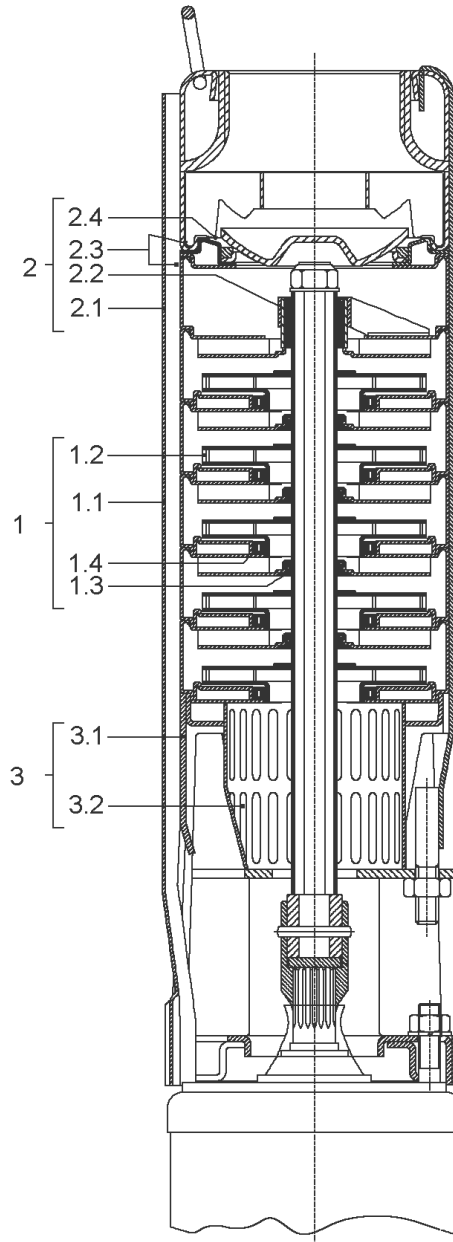

TWI4-0713-EMSC (4068896)

Item	Article no.	Description	Quantity
1		OTHERS STAGES KIT TWI4-07 PUMP	1
1.1		> DIFFUSER WITH RETURN GUIDE VANE	1
1.2		> PUMP IS 7 IMPELLER	1
1.3		> INTERMEDIATE BEARING	1
1.4		> NECK RING + STAINLESS STEEL PART (AISI)	1
2		SEVERE DUTY DISCHARGE KIT TWI4-07 PUMP	1
Note: no longer available / nicht mehr lieferbar / ne plus disponible			
2.1		> SEVERE DUTY DISCHARGE CHAMBER	1
2.2		> BEARING SPACER	1
3		SUCTION CASING AND STRAINER KIT TWI PUMP	1
3.1		> SUCTION INTERCONNECTOR	1
3.2		> STRAINER	1
	4003579	CAPACITOR-50MF	1

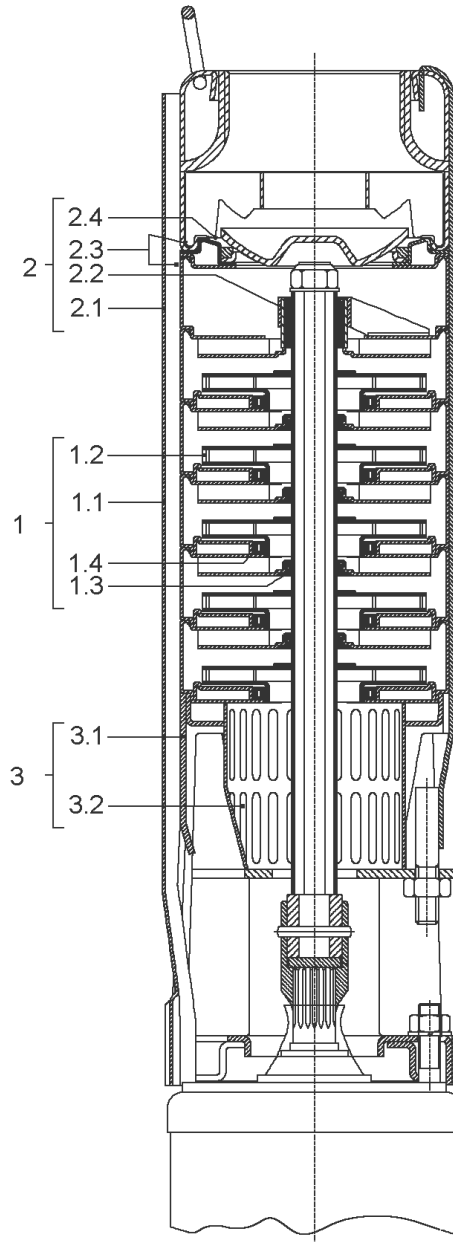

TWI4-0716-EMSC (4068897)

Item	Article no.	Description	Quantity
1		OTHERS STAGES KIT TWI4-07 PUMP	1
1.1		> DIFFUSER WITH RETURN GUIDE VANE	1
1.2		> PUMP IS 7 IMPELLER	1
1.3		> INTERMEDIATE BEARING	1
1.4		> NECK RING + STAINLESS STEEL PART (AISI)	1
2		SEVERE DUTY DISCHARGE KIT TWI4-07 PUMP	1
Note: no longer available / nicht mehr lieferbar / ne plus disponible			
2.1		> SEVERE DUTY DISCHARGE CHAMBER	1
2.2		> BEARING SPACER	1
3		SUCTION CASING AND STRAINER KIT TWI PUMP	1
3.1		> SUCTION INTERCONNECTOR	1
3.2		> STRAINER	1
	4080849	CAPACITOR-75 MF	1

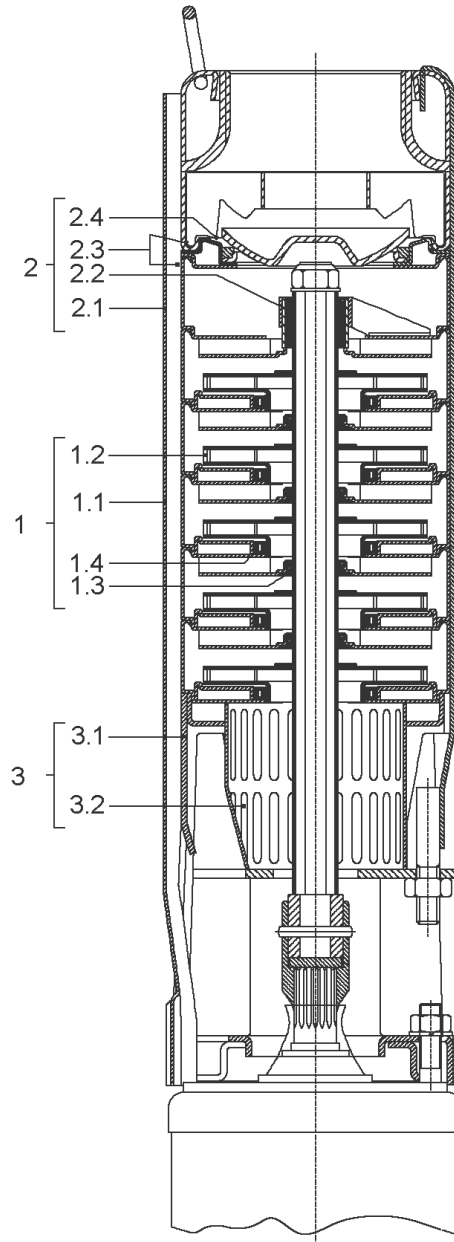

TWI4-0719-EMSC (4068898)

Item	Article no.	Description	Quantity
1		OTHERS STAGES KIT TWI4-07 PUMP	1
1.1		> DIFFUSER WITH RETURN GUIDE VANE	1
1.2		> PUMP IS 7 IMPELLER	1
1.3		> INTERMEDIATE BEARING	1
1.4		> NECK RING + STAINLESS STEEL PART (AISI)	1
2		SEVERE DUTY DISCHARGE KIT TWI4-07 PUMP	1
Note: no longer available / nicht mehr lieferbar / ne plus disponible			
2.1		> SEVERE DUTY DISCHARGE CHAMBER	1
2.2		> BEARING SPACER	1
3		SUCTION CASING AND STRAINER KIT TWI PUMP	1
3.1		> SUCTION INTERCONNECTOR	1
3.2		> STRAINER	1
	4080849	CAPACITOR-75 MF	1

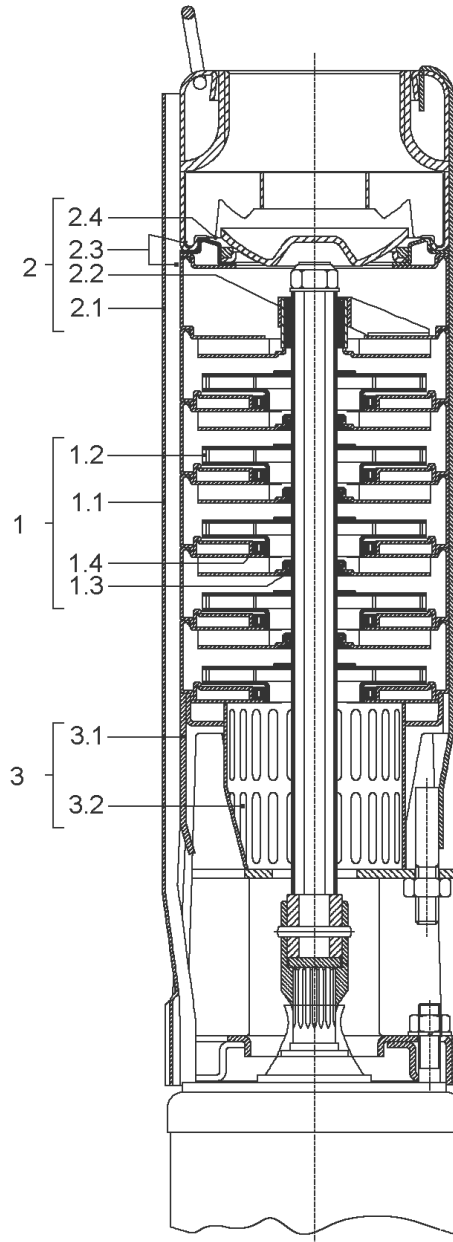

TWI4-1203-EMSC (4068899)

Item	Article no.	Description	Quantity
1		OTHERS STAGES KIT TWI4-12 PUMP	1
1.1		> DIFFUSER WITH RETURN GUIDE VANE	1
1.2		> PUMP IS 12 IMPELLER	1
1.3		> INTERMEDIATE BEARING	1
1.4		> NECK RING + STAINLESS STEEL PART (AISI)	1
2		SEVERE DUTY DISCHARGE KIT TWI12 PUMP	1
Note: no longer available / nicht mehr lieferbar / ne plus disponible			
3		SUCTION CASING AND STRAINER KIT TWI PUMP	1
3.1		> SUCTION INTERCONNECTOR	1
3.2		> STRAINER	1
	4003578	CAPACITOR-40MF	1



TWI4-1205-EMSC (4068900)

Item	Article no.	Description	Quantity
1		OTHERS STAGES KIT TWI4-12 PUMP	1
1.1		> DIFFUSER WITH RETURN GUIDE VANE	1
1.2		> PUMP IS 12 IMPELLER	1
1.3		> INTERMEDIATE BEARING	1
1.4		> NECK RING + STAINLESS STEEL PART (AISI)	1
2		SEVERE DUTY DISCHARGE KIT TWI12 PUMP	1
Note: no longer available / nicht mehr lieferbar / ne plus disponible			
3		SUCTION CASING AND STRAINER KIT TWI PUMP	1
3.1		> SUCTION INTERCONNECTOR	1
3.2		> STRAINER	1
	4003579	CAPACITOR-50MF	1

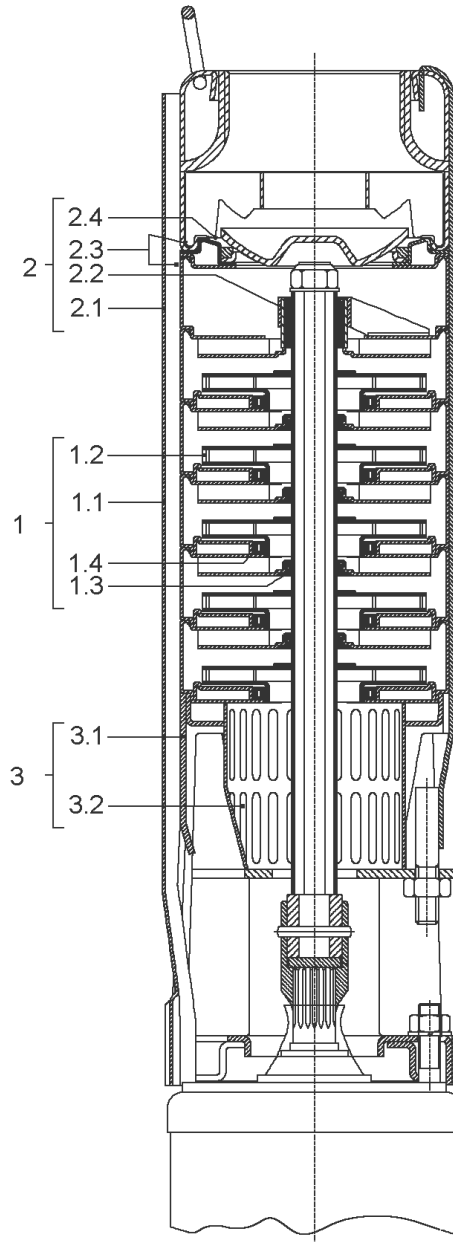

TWI4-1208-EMSC (4068901)

Item	Article no.	Description	Quantity
1		OTHERS STAGES KIT TWI4-12 PUMP	1
1.1		> DIFFUSER WITH RETURN GUIDE VANE	1
1.2		> PUMP IS 12 IMPELLER	1
1.3		> INTERMEDIATE BEARING	1
1.4		> NECK RING + STAINLESS STEEL PART (AISI)	1
2		SEVERE DUTY DISCHARGE KIT TWI12 PUMP	1
Note: no longer available / nicht mehr lieferbar / ne plus disponible			
3		SUCTION CASING AND STRAINER KIT TWI PUMP	1
3.1		> SUCTION INTERCONNECTOR	1
3.2		> STRAINER	1
	4080849	CAPACITOR-75 MF	1

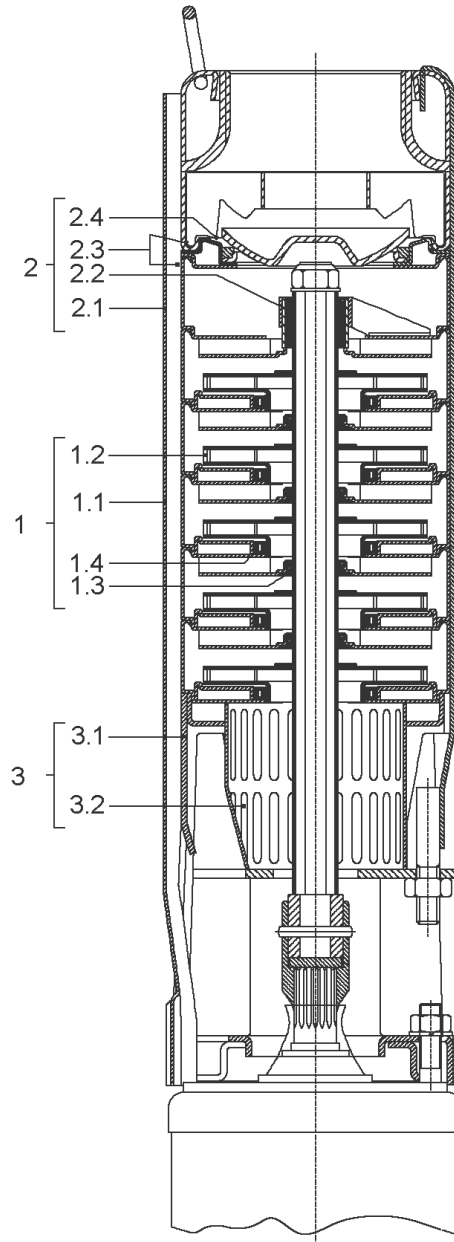

TWI4-0217-DM (4068918)

Item	Description	Quantity
1	OTHERS STAGES KIT TWI4-02 PUMP	1
Note: no longer available / nicht mehr lieferbar / ne plus disponible		
1.1	> DIFFUSER WITH RETURN GUIDE VANE	1
1.2	> PUMP IS 2 IMPELLER	1
1.3	> INTERMEDIATE BEARING	1
1.4	> NECK RING + STAINLESS STEEL PART (AISI)	1
2	STANDARD CASING DISCHARGE TWI4-02 PUMP	1
Note: no longer available / nicht mehr lieferbar / ne plus disponible		
2.1	> DISCHARGE CHAMBER	1
2.2	> BEARING SPACER	1
2.3	> VALVE SEAT AND RETAINER	1
2.4	> VALVE CONE	1
3	SUCTION CASING AND STRAINER KIT TWI PUMP	1
3.1	> SUCTION INTERCONNECTOR	1
3.2	> STRAINER	1

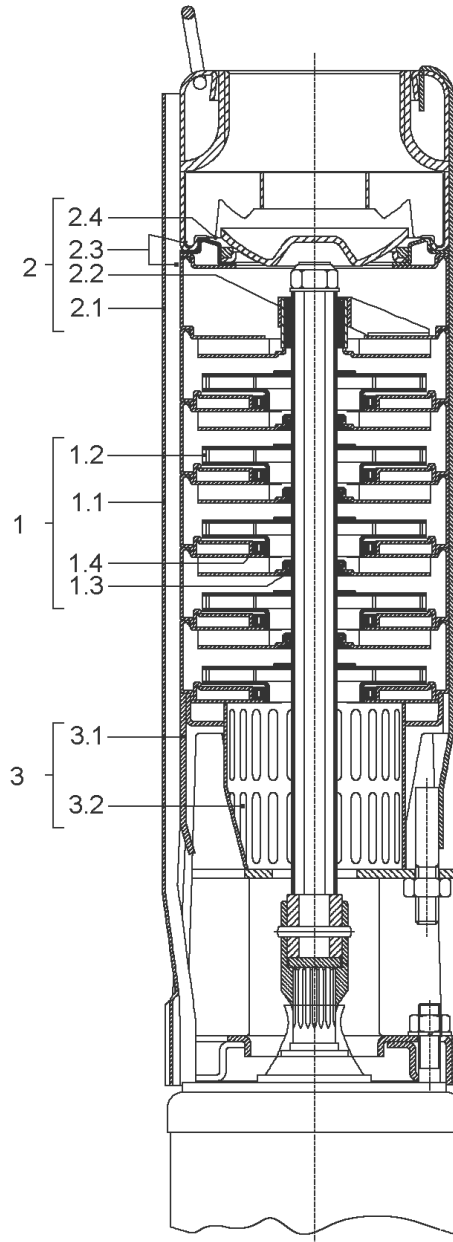

TWI4-0454-DM (4068919)

Item	Description	Quantity
1	OTHERS STAGES KIT TWI4-04 PUMP	1
1.1	> DIFFUSER WITH RETURN GUIDE VANE	1
1.2	> PUMP IS 4 IMPELLER	1
1.3	> INTERMEDIATE BEARING	1
1.4	> NECK RING + STAINLESS STEEL PART (AISI)	1
2	SEVERE DUTY DISCHARGE KIT TWI4-04 PUMP	1
Note: no longer available / nicht mehr lieferbar / ne plus disponible		
2.1	> SEVERE DUTY DISCHARGE CHAMBER	1
2.2	> BEARING SPACER	1
3	SUCTION CASING AND STRAINER KIT TWI PUMP	1
3.1	> SUCTION INTERCONNECTOR	1
3.2	> STRAINER	1